

7854 Oscilloscope Operators Manual

With Waveform Calculator

Tektronix, Inc.
P.O. Box 500
Beaverton, OR 97077

Serial Number

070-2873-00
Product Group 42

First Printing JAN 1980
Revised MAY 1989

Copyright © 1980 Tektronix, Inc. All rights reserved.
Contents of this publication may not be reproduced in any
form without the written permission of Tektronix, Inc.

Products of Tektronix, Inc. and its subsidiaries are covered
by U.S. and foreign patents and/or pending patents.

TEKTRONIX, TEK, SCOPE-MOBILE, and  are
registered trademarks of Tektronix, Inc. TELEQUIPMENT is
a registered trademark of Tektronix U.K. Limited.

Printed in U.S.A. Specification and price change privileges
are reserved.

INSTRUMENT SERIAL NUMBERS

Each instrument has a serial number on a panel insert, tag,
or stamped on the chassis. The first number or letter
designates the country of manufacture. The last five digits
of the serial number are assigned sequentially and are
unique to each instrument. Those manufactured in the
United states have six unique digits. The country of
manufacture is identified as follows:

B000000	Tektronix, Inc., Beaverton, Oregon, USA
100000	Tektronix Guernsey, Ltd., Channel Islands
200000	Tektronix United Kingdom, Ltd., London
300000	Sony/Tektronix, Japan
700000	Tektronix Holland, NV, Heerenveen, The Netherlands

TABLE OF CONTENTS

	Page
OPERATORS SAFETY SUMMARY	xii
MANUAL COLORS	xiv
 SECTION 1—INTRODUCTION	
7854 FEATURES	1-1
INSTALLATION	1-2
OPERATING POWER INFORMATION	1-2
OPERATING VOLTAGE	1-2
POWER CORD INFORMATION	1-2
MEMORY BACK-UP POWER	1-5
OPERATING TEMPERATURE	1-5
INSTALLING PLUG-IN UNITS	1-5
CONNECTING THE WAVEFORM CALCULATOR	1-6
GENERAL PURPOSE INTERFACE BUS (GPIB)	1-6
POWER-UP CONDITIONS	1-7
PRESET CONDITIONS	1-8
OPERATING POSITION	1-8
GLOSSARY OF TERMS	1-9
 SECTION 2—SPECIFICATION	
7854 MAINFRAME AND WAVEFORM CALCULATOR SPECIFICATIONS	2-1
PACKAGING AND ACCESSORIES	2-19
PACKAGING FOR SHIPMENT	2-19
STANDARD ACCESSORIES	2-19
7000-SERIES OSCILLOSCOPE SYSTEMS SPECIFICATIONS	2-20
 SECTION 3—GENERAL OPERATING INFORMATION	
DISPLAY GRATICULE	3-1
LIGHT FILTER	3-1
CARE OF CRT SCREEN	3-2
CONTROL ILLUMINATION	3-2
READOUT INTENSITY	3-2
DISPLAY FOCUS	3-2
ASTIGMATISM-FOCUS ADJUSTMENT	3-3
HORIZONTAL TRACE ALIGNMENT	3-3
CALIBRATOR OUTPUT	3-4
SIGNAL OUTPUTS	3-4
+ SAWTOOTH OUT	3-4
+ GATE OUT	3-5
SIGNAL OUT	3-5
DISPLAY PHOTOGRAPHY	3-5

TABLE OF CONTENTS (CONT)

	Page
SECTION 4—SCOPE DISPLAY MODE INFORMATION	
OBTAINING A SCOPE DISPLAY	4-1
A AND B INTENSITY CONTROLS	4-2
Z-AXIS MODULATION	4-2
USING THE BEAMFINDER	4-3
REAL-TIME READOUT DISPLAY	4-3
READOUT IDENTIFY	4-4
READOUT ACCESS PLUG-IN UNIT	4-5
VERTICAL AND HORIZONTAL MODE COMBINATIONS	4-5
VERTICAL MODES	4-5
Alternate Mode	4-5
Chopped Mode	4-7
Algebraic Addition	4-7
HORIZONTAL MODES	4-8
Alternate Mode	4-8
Chopped Mode	4-9
VERTICAL TRACE SEPARATION	4-9
INTENSITY CONTRAST	4-9
TRIGGER SOURCE	4-9
REAL-TIME FUNCTIONS CHECKOUT PROCEDURES	4-10
TEST EQUIPMENT REQUIRED	4-10
PRELIMINARY SETUP	4-11
DISPLAY FOCUS CHECKOUT	4-12
TRACE ALIGNMENT CHECKOUT	4-12
GRATICULE ILLUMINATION CHECKOUT	4-12
CONTROL ILLUMINATION AND TRACE INTENSITY CHECKOUT	4-12
VERTICAL DEFLECTION CHECKOUT	4-13
HORIZONTAL DEFLECTION CHECKOUT	4-14
TRIGGERING CHECKOUT	4-15
READOUT CHECKOUT	4-15
BEAMFINDER CHECKOUT	4-16
CALIBRATOR CHECKOUT	4-16
Z-AXIS INPUT CHECKOUT	4-16
SIGNAL OUT CHECKOUT	4-17
+ SAWTOOTH OUT CHECKOUT	4-17
+ GATE OUT CHECKOUT	4-17
SINGLE SWEEP RESET CHECKOUT	4-18
SECTION 5—USING THE MEASUREMENT KEYBOARD	
WAVEFORM STORAGE CONSIDERATIONS	5-1
COMMAND BUFFER	5-3
ERROR AND WARNING INDICATIONS	5-3
ERRORS	5-3
WARNINGS	5-3

TABLE OF CONTENTS (CONT)

	Page
WAVEFORM ACQUISITION EXERCISES	5-4
ACQUIRING A REPETITIVE WAVEFORM	5-4
SETTING THE GROUND REFERENCE (IN THE BOTH MODE)	5-7
AVERAGING A WAVEFORM	5-10
STOPPING ACQUISITION	5-11
ACQUIRING A SINGLE-SWEEP WAVEFORM	5-12
STORED CHARACTER DISPLAY	5-14
OPERATIONAL WAVEFORM STATUS	5-15
CURSOR STATUS	5-15
STACK AND PROCESSOR STATUS	5-15
NUMERIC DISPLAYS	5-15
CURSORS EXERCISE	5-17
POSITIONING THE CURSORS	5-17
WAVEFORM PARAMETER MEASUREMENTS	5-22
MAKING AMPLITUDE-PARAMETER MEASUREMENTS	5-22
MAKING TIME-PARAMETER MEASUREMENTS	5-27
Measuring a Pulse	5-29
Measuring a Pulse Train	5-31
BOTH DISPLAY MODE	5-34
SELECTING THE BOTH DISPLAY MODE	5-34
 SECTION 6—USING THE WAVEFORM CALCULATOR	
STORED DISPLAY MODE INFORMATION	6-1
MATHEMATICAL CALCULATIONS	6-1
OBTAINING A STORED DISPLAY WITHOUT WAVEFORMS	6-1
THE STACK	6-2
NUMERIC ENTRY	6-3
KEYING IN NUMBERS	6-5
ENTERING NEGATIVE NUMBERS	6-6
CLEARING THE X REGISTER	6-6
PERFORMING TWO-OPERAND FUNCTIONS WITH CONSTANTS	6-7
PERFORMING CHAIN CALCULATIONS	6-8
KEYING IN EXPONENTS	6-11
USING THE STACK	6-12
REVIEWING STACK CONTENTS	6-12
EXCHANGING X AND Y	6-13
CLEARING THE STACK	6-13
USING THE ENTER COMMAND	6-13
OBSERVING STACK OPERATION WITH SINGLE-OPERAND FUNCTIONS	6-15
USING THE CONSTANT REGISTERS	6-17
STORING A CONSTANT	6-17
RETRIEVING A CONSTANT	6-17

TABLE OF CONTENTS (CONT)

	Page
WAVEFORM PROCESSING	6-18
WAVEFORM MEMORIES AND RESOLUTION	6-18
WAVEFORM ACQUISITION AND DATA STORAGE	6-20
OBSERVING THE WAVEFORM MEMORIES AT POWER-UP	6-21
SETTING THE GROUND REFERENCE	6-23
ACQUIRING TWO WAVEFORMS	6-24
COPYING STORED WAVEFORMS	6-26
AVERAGING A WAVEFORM	6-28
OBSERVING EFFECTS OF A >P/W	6-29
RECALLING AND SETTING THE VALUE OF A POINT	6-32
DISPLAYING THE READOUT SETTING	6-35
COMPUTED WAVEFORM SCALING, OVERFLOW, AND UNDERFLOW ..	6-36
WAVEFORMS AS ARITHMETIC OPERANDS	6-36
OBSERVING WAVEFORMS WITH ONE-OPERAND	
ARITHMETIC FUNCTIONS	6-37
OBSERVING WAVEFORMS WITH TWO-OPERAND	
ARITHMETIC FUNCTIONS	6-41
STORED WAVEFORM DISPLAY	6-45
DISPLAYING STORED WAVEFORMS AS DOTS	
OR VECTORS	6-45
DISPLAYING SEVERAL STORED WAVEFORMS	6-47
CLEARING STORED WAVEFORMS FROM THE DISPLAY	6-50
DISPLAYING STORED WAVEFORMS IN THE X-Y MODE	6-51
DISPLAYING STORED WAVEFORMS IN THE Y-T MODE	6-54
CURSORS	6-55
POSITIONING THE CURSORS	6-55
RECALLING CURSOR COORDINATES	6-62
WAVEFORM SCALING, EXPANSION, AND POSITIONING	6-63
SETTING THE SCALE FACTORS	6-63
RECALLING THE SCALE FACTORS	6-66
EXPANDING THE STORED WAVEFORM	6-67
Vertical Expansion	6-67
Horizontal Expansion	6-68
POSITIONING THE STORED WAVEFORM	6-72
Vertical Positioning	6-72
Horizontal Positioning	6-75
WAVEFORM FUNCTIONS	6-83
DIFFERENTIATING A WAVEFORM	6-83
INTEGRATING A WAVEFORM	6-84
SMOOTHING THE WAVEFORM	6-85
RECALLING AND SETTING AN ORDINATE VALUE	6-86
INTERPOLATING ON THE WAVEFORM	6-88
PROGRAMMING	6-94
PROGRAM MEMORY	6-94
PROGRAM MODES	6-95

TABLE OF CONTENTS (CONT)

	Page
THE ENTRY AND EDIT DISPLAYS	6-95
THE ENTRY MODE	6-96
THE EDIT MODE	6-97
THE EXECUTE MODE	6-97
AN INTRODUCTORY PROGRAM	6-98
ENTERING THE PROGRAM	6-99
EXECUTING THE PROGRAM	6-104
CLEARING THE PROGRAM	6-105
PROGRAMMING TECHNIQUES	6-106
FLOWCHARTS	6-106
DEFINE PROGRAM BEGINNING	6-110
PROGRAM INITIALIZATION	6-110
THE PROGRAM BODY	6-110
Unconditional Branching	6-110
Looping	6-111
Conditional Branching	6-111
Subroutines	6-111
DEFINE PROGRAM ENDING	6-111
WRITING A PROGRAM	6-112
CREATING A PULSE-MEASURING PROGRAM	6-113
ENTERING THE PULSE-MEASURING PROGRAM	6-114
EXECUTING A PROGRAM	6-117
STARTING THE PULSE-MEASURING PROGRAM	6-117
RUNNING THE PULSE-MEASURING PROGRAM	6-118
STEPPING THROUGH THE PULSE-MEASURING PROGRAM	6-120
EDITING A PROGRAM	6-121
ALTERING THE PULSE-MEASURING PROGRAM	6-121
USING SUBROUTINES	6-125
PROGRAM INTERRUPTIONS	6-132
USING THE STORED STOP	6-132
PAUSING TO VIEW PROGRAM RESULTS	6-133
THE DIRECT STOP	6-134
PROGRAM EXAMPLES	6-135
PERCENT OF OVERSHOOT	6-135
PROPAGATION DELAY	6-136
CONVOLUTION OF WAVEFORMS	6-136
SINE OF WAVEFORMS	6-137
 SECTION 7—GPIB INFORMATION	
DESCRIPTION	7-1
GPIB FUNCTIONS	7-2
ADDRESS SELECTION	7-3
POWER-UP AND RESET STATES	7-4
POWER-UP STATE	7-4

TABLE OF CONTENTS (CONT)

	Page
RESET STATES	7-4
Device Clear	7-4
Interface Clear	7-4
Stop Key	7-4
MESSAGES	7-5
GPIB INTERFACE MESSAGES	7-5
DEVICE-DEPENDENT MESSAGES	7-6
COMMANDS	7-6
Input/Output Commands	7-8
Service Request Control	7-8
Queries	7-9
DATA TRANSFERS	7-9
Programs	7-9
Numeric Values	7-11
Waveforms	7-13
Text	7-17
SERVICE REQUEST	7-18
Status Bytes	7-20
Polling	7-22
GPIB THEORY	7-22
GPIB SIGNAL LINES	7-22
THE HANDSHAKE	7-23

SECTION 8—INSTRUMENT OPTIONS

OPTION 02	8-1
OPTION 03	8-1
OPTION 78	8-1
OPTION 0D	8-1
OPTION 2D	8-1
OPTION A1	8-1
OPTION A2	8-1
OPTION A3	8-1
OPTION A4	8-1
OPTION 1S	8-2
OPTION 2S	8-2
INSTRUMENT OPTION IDENTIFICATION	8-2

SECTION 9—COMMAND LANGUAGE

OPERATIONAL CONVENTIONS	9-1
OPERATING MODES	9-1
CRT DISPLAY	9-1
REAL-TIME WAVEFORMS AND READOUT DISPLAY	9-1

TABLE OF CONTENTS (CONT)

	Page
STORED WAVEFORMS AND CHARACTER DISPLAY	9-1
Y-T Mode	9-7
X-Y Mode	9-7
STORED WAVEFORM ACQUISITION	9-8
REAL-TIME WAVEFORM ACQUISITION	9-8
REPETITIVE DIGITIZING	9-8
REAL-TIME DIGITIZING	9-9
UNFILLED/ERRONEOUS POINTS	9-9
WAVEFORM STORAGE	9-9
WAVEFORM RESULTS	9-10
OVERFLOW AND UNDERFLOW	9-10
Large And Small Constants	9-10
Large And Small Waveforms	9-10
INSTRUMENT COMMANDS	9-11
ARITHMETIC FUNCTIONS	9-11
CRT DISPLAY	9-15
CURSORS	9-15
ONE CURSOR	9-15
TWO CURSORS	9-15
CURSOR MOVEMENT	9-16
DATA STORAGE	9-19
EXTERNAL FUNCTIONS	9-22
NUMBER ENTRY	9-24
NUMERIC ENTRY	9-25
Number Entry Display	9-25
PROGRAM ENTRY/EXECUTE	9-27
SHIFT FUNCTION	9-35
STACK	9-36
STORED WFM DISPLAY	9-37
VERTICAL POSITION	9-40
WFM ACQUISITION	9-41
WFM FUNCTIONS	9-46
WFM PARAMETERS	9-52
WFM SCALING	9-56
GPIB COMMANDS	9-58
MESSAGES AND ALGORITHMS	9-60
ERROR AND WARNING MESSAGES	9-60
COMMAND ALGORITHMS	9-72
AREA	9-72
AVG	9-73
DIFF	9-74
ENERGY	9-74
HXP	9-75
HXPDP	9-75
INTG	9-75

TABLE OF CONTENTS (CONT)

	Page
MEAN	9-75
PER	9-76
RMS	9-76
SMOOTH	9-76

APPENDIX A—COMMAND INDEX

LIST OF ILLUSTRATIONS

Figure No.		Page
A	Locator for 7854 front-panel controls, connectors, and indicators.....	xvi
B	Locator for keys and indicators on the 7854 front-panel measurement keyboard	xx
C	Locator for 7854 rear-panel controls, connectors, and indicators	xxiv
D	Locator for Waveform Calculator keys and indicators	xxvi
1-1	Definition of Data Path Terms	1-11
2-1	7854 Mainframe dimensional drawing	2-17
2-2	7854 Waveform Calculator dimensional drawing	2-18
3-1	Definition of graticule markings.....	3-1
4-1	Location and definition of the real-time readout.....	4-4
5-1	The acquisition graticule in relation to the display graticule	5-2
5-2	The input pulse of a repetitive signal is reconstructed using equivalent-time random-sampling.....	5-5
5-3	The single-sweep input signal is sequentially sampled and each point is displayed as it actually occurred	5-13
5-4	Typical character display of STORED mode.....	5-14
5-5	Time-parameter relationships	5-29
6-1	A demonstration of stack "pushing" and "popping"	6-4
6-2	A typical program display on the 7854 Oscilloscope	6-95
6-3	Example of the program Entry mode without previously stored programs	6-96
6-4	Example of the program Entry mode with a previously stored program	6-96
6-5	Example of the program Edit mode	6-97
6-6	Basic flowchart of the introductory program.....	6-107
6-7	Detailed flowchart of the introductory program	6-108
6-8	Flowchart for the basic pulse-measuring program	6-109
6-9	Listing of the basic pulse-measuring program	6-116
6-10	Typical display after executing the pulse-measuring program ...	6-117
6-11	Flowchart for the pulse-measuring program using a loop.....	6-122
6-12	Listing of the pulse-measuring program with a loop	6-124
6-13	Flowchart of main body of the pulse-measuring program using subroutines	6-126
6-14	Flowchart of the cursor-positioning subroutine	6-127
6-15	Flowchart of the amplitude-monitoring subroutine	6-128
6-16	Listing of pulse-measuring program and cursor-positioning subroutine.....	6-130
6-17	Listing of the cursor-positioning and amplitude-monitoring subroutine.....	6-131
6-18	Listing of the pulse-measuring program with commands added to view results	6-134
6-19	Program to calculate the percent of overshoot	6-135

LIST OF ILLUSTRATIONS (CONT)

Figure No.		Page
6-20	Program to calculate propagation delay	6-136
6-21	Program to convolve waveforms	6-136
6-22	Program to display the sine of a waveform	6-137
7-1	GPIB system configurations	7-1
7-2	Address and mode selection	7-3
7-3	Device-dependent messages vs. interface messages	7-5
7-4	Subroutine to set 7854 for remote-only operation (disable keyboards)	7-7
7-5	Subroutine to set 7854 for normal (remote/local) operation	7-7
7-6	Transfer 7854 program to controller tape file (SAVE sample program)	7-10
7-7	Transfer 7854 program from controller tape file to 7854	7-11
7-8	SENDX sample program	7-12
7-9	READX sample program	7-12
7-10	Waveform transfer from 7854 to controller (ASCII strings)	7-14
7-11	Waveform transfer from 7854 to controller (numeric array)	7-15
7-12	Waveform transfer from controller (ASCII strings) to 7854	7-15
7-13	Waveform transfer from controller (numeric array) to 7854	7-16
7-14	>TEXT sample program	7-19
7-15	TEXT sample program	7-20
7-16	Serial-poll sample subroutines	7-22
7-17	Source and acceptor handshake sequence	7-24
8-1	Location of Option Identification Tags	8-2
9-1	The 7854 hierarchy of operational modes	9-2
9-2	Character display fields utilized in the SCOPE mode	9-3
9-3	Character displayfields utilized in the STORED or BOTH mode	9-4
9-4	Character display fields utilized in the program Entry and Edit modes	9-6
9-5	Algorithm terms defined	9-72

LIST OF TABLES

Table No.		Page
1-1	Power-Cord Conductor Identification	1-3
1-2	Power-Cord and Plug Identification Information	1-4
1-3	Self-Test Fault Code	1-7
2-1	Electrical Characteristics	2-1
2-2	Environmental Characteristics	2-14
2-3	Physical Characteristics	2-16
2-4	7854 Horizontal System Specifications	2-21
2-5	7854 Vertical System Specifications	2-22
2-6	7854 Plug-In Incompatibilities	2-24
4-1	Real-Time Display Combinations	4-6
5-1	Letter Exponents	5-16
6-1	P/W Effects	6-19
7-1	7854 GPIB Interface Functions	7-2
7-2	Special Character Codes	7-17
7-3	7854 Status Bytes	7-21
8-1	Option Information Locator	8-3
9-1	Points-per-Waveform vs. Horizontal Resolution	9-1
9-2	Arithmetic Commands	9-11
9-3	Operands and Results	9-14
9-4	CRT Display Commands	9-15
9-5	Cursor Commands	9-16
9-6	Data Storage Commands	9-19
9-7	External Interface Commands	9-22
9-8	Number Entry Commands	9-24
9-9	Number Entry Fields	9-25
9-10	Program Entry and Execute Commands	9-27
9-11	Shift Flag Commands	9-35
9-12	Stack Control Commands	9-36
9-13	Stored Waveform Display Commands	9-37
9-14	Vertical Position Commands	9-40
9-15	Waveform Acquisition Commands	9-41
9-16	Waveform Function Commands	9-46
9-17	Waveform Parameter Commands	9-52
9-18	Waveform Scaling Commands	9-56
9-19	GPIB Only Commands	9-58
9-20	Error Messages	9-60
9-21	Warning Messages	9-68

OPERATORS SAFETY SUMMARY

The general safety information in this part of the summary is for both operating and servicing personnel. Specific warnings and cautions will be found throughout the manual where they apply, but may not appear in this summary.

TERMS

IN THIS MANUAL

CAUTION statements identify conditions or practices that could result in damage to the equipment or other property.

WARNING statements identify conditions or practices that could result in personal injury or loss of life.

AS MARKED ON EQUIPMENT

CAUTION indicates a personal injury hazard not immediately accessible as one reads the marking, or a hazard to property including the equipment itself.

DANGER indicates a personal injury hazard immediately accessible as one reads the marking.

SYMBOLS

IN THIS MANUAL

 Static-Sensitive Devices.

 This symbol indicates where applicable cautionary or other information is to be found.

AS MARKED ON EQUIPMENT

 **DANGER**—High voltage.

 Protective ground (earth) terminal.

 **ATTENTION**—refer to manual.

WARNINGS

POWER SOURCE

This product is intended to operate from a power source that will not apply more than 250 volts rms between the supply conductors or between either supply conductor and ground. A protective ground connection by way of the grounding conductor in the power cord is essential for safe operation.

USE THE PROPER POWER CORD

Use only the power cord and connector specified for your product. Use only a power cord that is in good condition.

For detailed information on power cords, refer to Section 1, Introduction.

Refer cord and connector changes to qualified service personnel.

GROUNDING THE PRODUCT

This product is grounded through the grounding conductor of the power cord. To avoid electrical shock, plug the power cord into a properly wired receptacle before connecting to the product input or output terminals. A protective ground connection by way of the grounding conductor in the power cord is essential for safe operation.

DANGER ARISING FROM LOSS OF GROUND

Upon loss of the protective-ground connection, all accessible conductive parts (including knobs and controls that may appear to be insulating), can render an electric shock.

USE THE PROPER FUSE

To avoid fire hazard, use only the fuse specified in the parts list for your product, and which is identical in type, voltage rating, and current rating.

Refer fuse replacement to qualified service personnel.

DO NOT OPERATE IN EXPLOSIVE ATMOSPHERES

To avoid explosion, do not operate this product in an atmosphere of explosive gases unless it has been specifically certified for such operation.

DO NOT REMOVE COVERS OR PANELS

To avoid personal injury, do not remove the product covers or panels. Do not operate the product without the covers and panels properly installed.

MANUAL COLORS

The colors of black, blue, brown, and green are used throughout this manual to high-light specific features of the manual designed to aid you in understanding the operation of your 7854 Oscilloscope.

In addition to being used for the main body of text, black is used on the graticule displays of the self-teaching exercises to indicate information which has not changed during execution of the associated commands.

Certain command mnemonics (such as **BOTH**, **AQS**, **FREQ**, etc.) are printed in blue as they appear on the instrument keyboard(s). A blue mnemonic indicates that the command is invoked as a "shift function" and must be preceded with the *f* command unless issued through the GPIB. Also, blue boxes surround applications information given throughout the self-teaching exercises.

Exercise headings (such as **ACQUIRING A SINGLE-SWEEP WAVEFORM**) and procedure titles (such as **USING THE BEAMFINDER**) are printed in brown at the start of the exercise or procedure. In addition, brown is used for the following symbol to indicate places where the 7854 can be turned off without affecting the next exercises:

NEXT EXERCISE BEGINS WITH POWER-UP

Green is used in the text to indicate nomenclature precisely as it appears on the 7854 display screen (e.g., **AQR WARNING**, **BUSY**, **FRE ERROR**, **HCRD**, etc.). However, green used in the display graticules of the self-teaching exercises reflects information either newly displayed or changed as the direct result of executing the associated commands.

FRONT-PANEL DESCRIPTIONS (Cont)

- ⑮ **STORED INTensity**—Controls brightness of the stored waveform display.
- ⑰ **S Stored Intensity (Indicator)**—Illuminates when in STORED or BOTH display mode.
- ⑱ **READOUT Intensity**—Controls brightness of the alphanumeric readout display. Disables readout system in counterclockwise detent position.
- ⑲ **GRAT ILLUM**—Controls illumination of graticule lines.
- ⑳ **CONTRAST**—Screwdriver adjustment to control brightness contrast between real-time intensified zones and the waveform display.
- ㉑ **ASTIG**—Screwdriver adjustment used in conjunction with FOCUS control to obtain a well-defined display.
- ㉒ **TRACE ROTATION**—Screwdriver adjustment to align trace(s) with horizontal graticule lines.
- ㉓ **Measurement Keyboard (not labeled)**—Controls internal waveform processor functions and selects crt display modes. (See Figure B for details.)

MEASUREMENT-KEYBOARD DESCRIPTIONS (Cont)

③ CURSORS

NOTE

The cursors, when on, are displayed on the OPW in the STORED or BOTH CRT DISPLAY modes as intensified points.

CRS2-1 Turns on both cursors. Displays the coordinates of Cursor 2 relative to Cursor 1 in line #15 of the display.

CRS1 Shift function of **CRS2-1**; turns on Cursor 1 only. Displays the coordinates of Cursor 1 relative to the start of the waveform in line #15 of the display.

CRS1< Moves Cursor 1, if on, toward the start of the waveform.

CRS1> Moves Cursor 1, if on, toward the end of the waveform.

CRS2< Moves Cursor 2, if on, toward Cursor 1.

CRS2> Moves Cursor 2, if on, toward the end of the waveform.

OFF Turns off the cursors.

④  Selects the shift function of the next key pressed.

⑤ EXTERNAL

NOTE

The following keys and indicators are used primarily in conjunction with the GPIB (General Purpose Interface Bus).

ROS Asserts a service request from the 7854.

ID Displays the 7854 identification message on the crt.

REMOTE ONLY (Indicator)—Illuminates when the 7854 is being remotely controlled over the GPIB and the keyboard is locked out.

SRQ (Indicator)—Illuminates when a service request is being asserted by the 7854.

I/O (Indicator)—Illuminates when the 7854 is addressed to talk or listen over the GPIB.

ERROR (Indicator)—Illuminates when an error or warning condition occurs.

MEASUREMENT-KEYBOARD DESCRIPTIONS (Cont)

⑥ WFM ACQUISITION

BUSY (Indicator)—Illuminates when the processor is busy executing a command.

STOP Prematurely ends execution of GND, AQR, AVG, AVG10, AVG100, or AVG1000 commands; aborts all pending commands. Stops program execution.

GND Presets ground reference for subsequent waveform acquisition. Ground reference is set at the algebraic mean vertical position of the real-time trace(s).

AQR Acquires repetitive real-time waveform(s) with readout; stores result in waveform memory.

AQS Shift function of **AQR**; acquires single-sweep waveform with readout; stores result in waveform memory.

AVG1000 Averages repetitive real-time waveform 1000 times; stores resulting waveform with scale factors in waveform memory.

AVG100 Averages repetitive real-time waveform 100 times; stores resulting waveform with scale factors in waveform memory.

AVG10 Averages repetitive real-time waveform 10 times; stores resulting waveform with scale factors in waveform memory.

⑦ CRT DISPLAY

SCOPE Selects real-time waveform and readout display mode.

STORED Selects stored waveform and character display mode.

BOTH Shift function of **STORED**; selects mixed display of real-time waveform and stored waveform with character display.

Front Panel Measurement Keys & Indicators
Foldout for
(Figure B) 

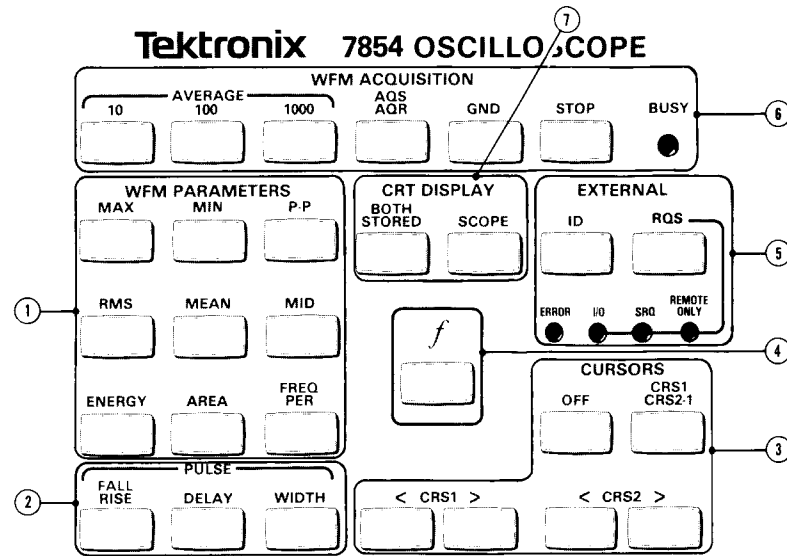

Figure B. Locator for keys and indicators on the 7854 front-panel measurement keyboard.

MEASUREMENT-KEYBOARD DESCRIPTIONS

① WFM PARAMETERS

NOTE

The following parameters are computed on the OPW (operational waveform) between and including the cursors, if on. The results are returned to the X register and displayed in its field in the STORED or BOTH CRT DISPLAY modes.

- MAX** Computes the waveform's most positive value, relative to the VZR (vertical zero reference).
- MIN** Computes the waveform's most negative value, relative to the VZR.
- P-P** Computes the waveform's peak-to-peak value (MAX - MIN).
- RMS** Computes the waveform's root-mean-square value.
- MEAN** Computes the waveform's algebraic mean value.
- MID** Computes the waveform's middle value $[(MAX + MIN) / 2]$.
- AREA** Computes the area under the waveform.
- ENERGY** Computes the waveform's energy.
- PER** Computes the waveform's period.
- FREQ** Shift function of **PER**; computes the waveform's frequency.

② PULSE Parameters

NOTE

The following parameters are computed on the OPW as defined by the cursor positions. Cursor 1 identifies the pulse baseline and Cursor 2 identifies the pulse top. The results are returned to the X register and displayed in its field in the STORED or BOTH CRT DISPLAY modes.

- RISE** Computes the rise time of the waveform's identified pulse.
- FALL** Shift function of **RISE**; computes the fall time of the waveform's identified pulse.
- DELAY** Computes the delay time of the waveform's identified pulse.
- WIDTH** Computes the width of the waveform's identified pulse.

Front Panel Controls, Connectors & Indicators
Foldout for
(Figure A) 

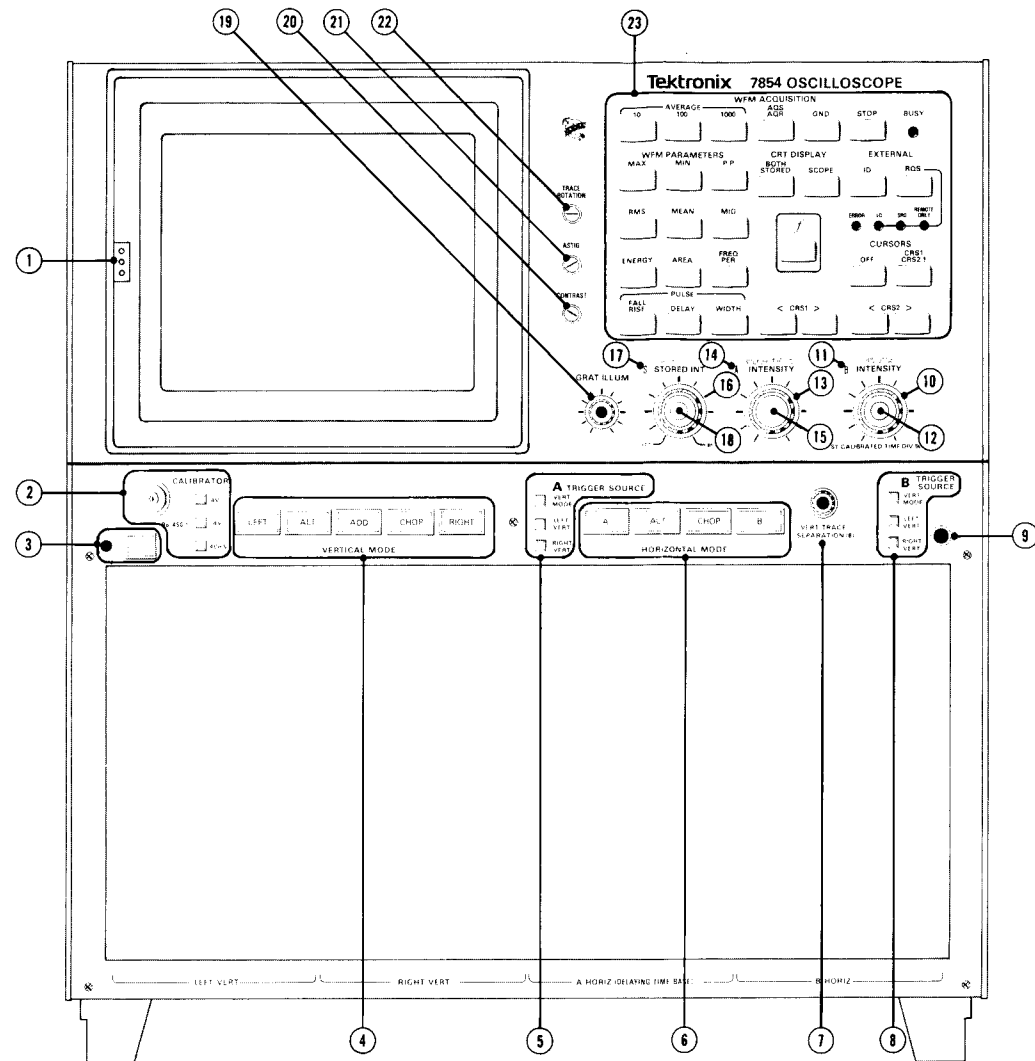

Figure A. Locator for 7854 front-panel controls, connectors, and indicators.

FRONT-PANEL DESCRIPTIONS

- ① **Camera Power Connector (not labeled)**—Three-pin connector provides power for camera operation and receives single-sweep reset signal.
- ② **CALIBRATOR (Switch and Output Connector)**—Provides calibrated 1-kHz square-wave voltages.
- ③ **POWER (Switch and Indicator)**—Switch controls power to the instrument; indicator illuminates when power is on.
- ④ **VERTICAL MODE**—Selects plug-in unit(s) for real-time input source of vertical deflection. Status indicated by illuminated button.
- ⑤ **A TRIGGER SOURCE**—Selects real-time internal trigger source for A HORIZ plug-in unit.
- ⑥ **HORIZONTAL MODE**—Selects plug-in unit(s) for real-time input source of horizontal deflection. Status indicated by illuminated button.
- ⑦ **VERT TRACE SEPARATION (B)**—Vertically positions the B HORIZ trace with respect to the A HORIZ trace (dual-sweep real-time modes only).
- ⑧ **B TRIGGER SOURCE**—Selects real-time internal trigger source for B HORIZ plug-in unit.
- ⑨ **Ground (not labeled)**—Binding post to establish common ground between associated equipment.
- ⑩ **B INTENSITY**—Controls brightness of real-time trace produced by the plug-in unit installed in the B HORIZ compartment.
- ⑪ **B Intensity (Indicator)**—Illuminates when selected by HORIZONTAL MODE switch.
- ⑫ **FOCUS**—Controls crt trace definition.
- ⑬ **A INTENSITY**—Controls brightness of real-time trace produced by the plug-in unit installed in the A HORIZ compartment.
- ⑭ **A Intensity (Indicator)**—Illuminates when selected by HORIZONTAL MODE switch.
- ⑮ **BEAMFINDER**—When pressed, compresses and defocuses displayed real-time waveforms within graticule area.

Rear Panel Controls, Connectors & Indicators

Foldout for
(Figure C)



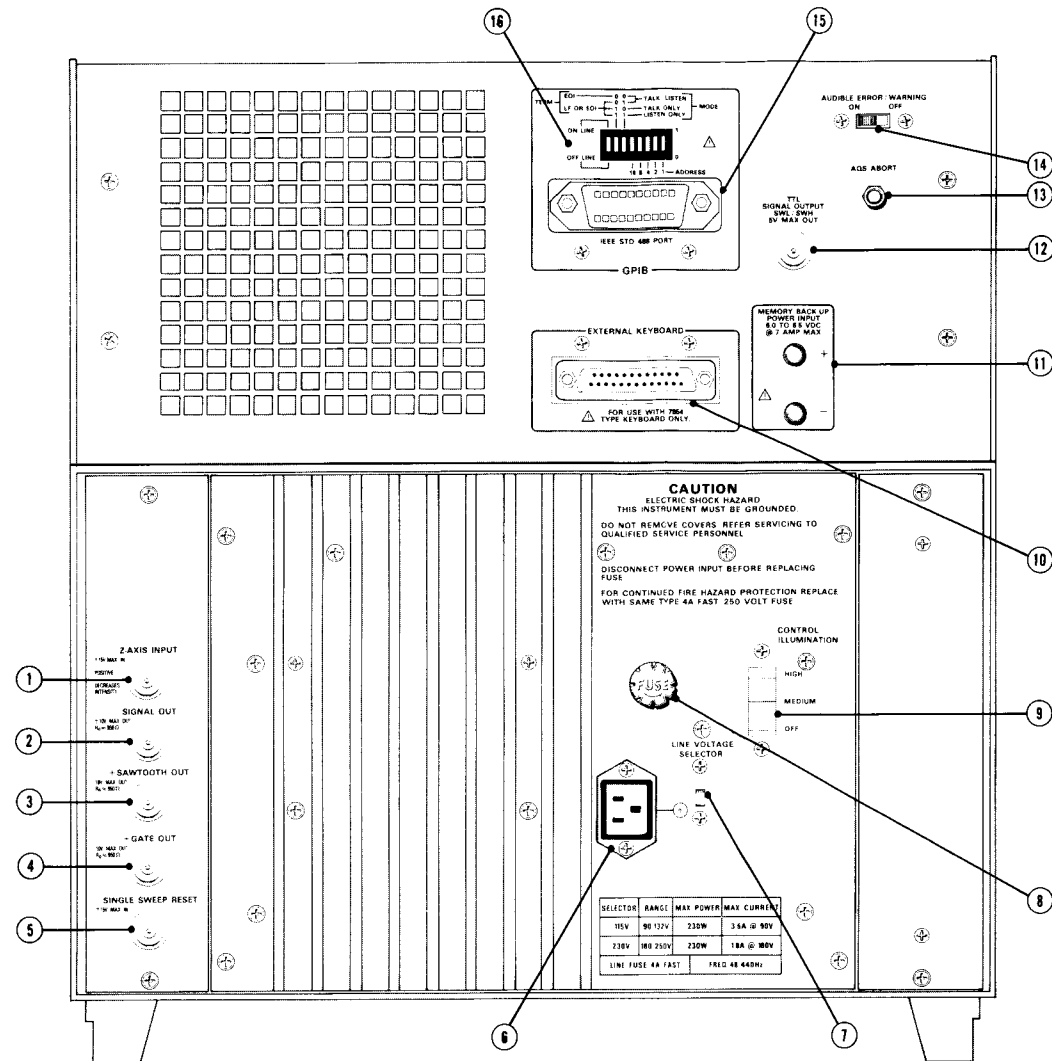

Figure C. Locator for 7854 rear-panel controls, connectors, and indicators.

REAR-PANEL DESCRIPTIONS

- ① **Z-AXIS INPUT**—Input for external intensity modulation of the real-time crt display.
- ② **SIGNAL OUT**—Output signal derived from vertical signal as selected by A TRIGGER SOURCE switch.
- ③ **+ SAWTOOTH OUT**—Sawtooth output signal derived from the A or B time-base unit.
- ④ **+ GATE OUT**—Output signal derived from either the A Gate, B Gate, or A Dly'd Gate.
- ⑤ **SINGLE SWEEP RESET**—Input to reset single-sweep function of A and B time-base units.
- ⑥ **Power Cord Input**—Input to allow attachment of power cord.
- ⑦ **LINE VOLTAGE SELECTOR**—Sets instrument for 115-volt or 230-volt nominal line operation.
- ⑧ **LINE FUSE**—4 A fast-blowing type.
- ⑨ **CONTROL ILLUMINATION**—Sets illumination level of TRIGGER SOURCE switches and lighted push-button switches on associated plug-in units.
- ⑩ **EXTERNAL KEYBOARD Connector**—Allows connecting an external keyboard such as the 7854 Waveform Calculator, to the mainframe.
- ⑪ **MEMORY BACK-UP POWER Connectors**—Two female banana jacks for applying 5.5 to 6.5 V DC to provide non-volatile memory.
- ⑫ **TTL SIGNAL OUTPUT SWL/SWH**—BNC connector to provide TTL-compatible signal. Level set by operator with Waveform Calculator keyboard.
- ⑬ **AQS ABORT**—Pushbutton switch to terminate AQS command.
- ⑭ **AUDIBLE ERROR/WARNING ON-OFF**—Switch to enable (ON) or disable (OFF) audio tones internally generated under error or warning conditions.
- ⑮ **GPIB Connector**—IEEE 488 1978 specified connector to allow connecting the instrument to the GPIB. (Not available with Options 0D & 1D.)
- ⑯ **GPIB Address Selection**—An eight-element, binary-coded switch to select GPIB mode and address.

Waveform Calculator Keys & Indicators
Foldout for 
(Figure D)

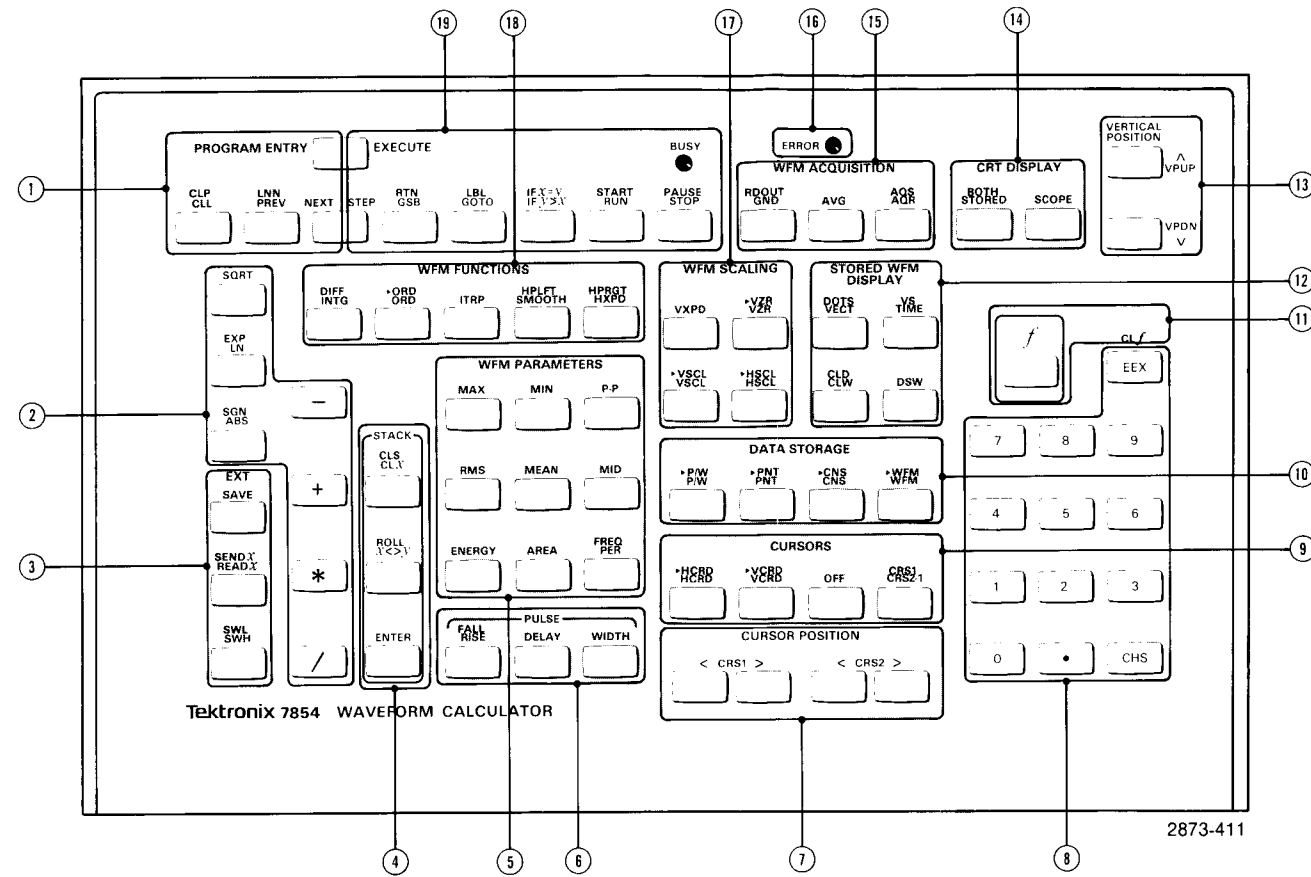

Figure D. Locator for Waveform Calculator keys and indicators.

WAVEFORM CALCULATOR DESCRIPTIONS

① PROGRAM ENTRY

NOTE

The following program commands, except LNN are not programmable and can only be invoked by direct execution.

- PROG** Switches the processor and the display to the program Edit mode to allow writing a program. This function is invoked with alternate actuations of the key.
- NEXT** In the Entry mode: terminates a new program line being inserted and advances the edit prompt to the next line. In the Edit mode: advances the edit prompt to the next line.
- CLL** In the Entry mode: deletes a new program line and returns to the Edit mode with the edit prompt at the next line. In the Edit mode: deletes the edit line and leaves the edit prompt at the same line.
- CLP** Shift function of **CLL**; deletes entire program. Returns to the Edit mode if actuated while in the Entry mode.
- PREV** In the Entry mode: performs an implicit NEXT command, then returns prompt to the previous line.
- LNN** Shift function of **PREV**; begins storage of a numeric label in the program and must be followed by two digit-entry commands for the label.

② Arithmetic Commands

NOTE

If the operand(s) for the following functions are constants the result is a constant given in the X register. If, however, the operand is a waveform, the result is a new waveform returned to waveform memory.

- SQRT** Computes the square root of the contents of the X register.
- LN** Computes the natural logarithm of the contents of the X register.
- EXP** Shift function of **LN**. Computes the exponential function of the contents of the X register.
- ABS** Computes the absolute value of the contents of the X register.

WAVEFORM CALCULATOR DESCRIPTIONS (Cont)

- SGN** Shift function of **ABS**. Computes the signum of the contents of the X register.
- Subtracts the contents of the X register from the contents of the Y register.
- +** Adds the contents of the X register to the contents of the Y register.
- *** Multiplies the contents of the Y register by the contents of the X register.
- /** Divides the contents of the Y register by the contents of the X register.

③ **EXTernal**

- SAVE** Sends one record of the program (from the current program line to the end-of-program line) to the external GPIB interface. This function is not programmable.
- READX** Reads data from the external GPIB interface; constants are returned to the X register, waveforms are placed in waveform memory.
- SENDX** Shift function of **READX**. Sends the data from the X register, or if the X register contains a waveform memory address the data from the specified waveform memory is sent, to the external GPIB interface.
- SWH** Sets the level of rear-panel TTL SIGNAL OUTPUT to high.
- SWL** Shift function of **SWH**. Sets the level of rear-panel TTL SIGNAL OUTPUT to low.

④ **STACK Control**

- ENTER** Terminates number entry into the X register if in the number entry state, otherwise, pushes the stack to enter new data.
- X<>Y** Interchanges the contents of the Y and X registers.
- ROLL** Shift function of **X<>Y**. Rolls the contents of the stack registers.
- CLX** Clears the X register by popping the stack.
- CLS** Shift function of **CLX**. Clears the stack by setting the stack registers to 0.

7854 Operators

WAVEFORM CALCULATOR DESCRIPTIONS (Cont)

⑤ WFM PARAMATERS (Duplicated on the measurement keyboard.)

NOTE

The following parameters are computed on the operational waveform between and including the cursors, if on. The results are returned to the X register and displayed in its field in the STORED or BOTH CRT DISPLAY modes.

MAX	Computes the operational waveform's most positive value, relative to the vertical zero reference (VZR).
MIN	Computes the operational waveform's most negative value, relative to the VZR.
P-P	Computes the operational waveform's peak-to-peak value (MAX - MIN).
RMS	Computes the operational waveform's root-mean-square value.
MEAN	Computes the operational waveform's algebraic mean value.
MID	Computes the operational waveform's middle value $[(MAX + MIN) / 2]$.
AREA	Computes the area under the operational waveform.
ENERGY	Computes the operational waveform's energy.
PER	Computes the operational waveform's period.
FREQ	Shift function of PER . Computes the operational waveform's frequency.

⑥ PULSE Parameters (Duplicated on the measurement keyboard.)

NOTE

The following parameters are computed on the operational waveform as defined by the cursor positions. Cursor 1 identifies the pulse baseline and Cursor 2 identifies the pulse top. The results are returned to the X register and displayed in its field in the STORED or BOTH CRT DISPLAY modes.

RISE	Computes the rise time of the identified operational waveform pulse.
FALL	Shift function of RISE . Computes the fall time of the identified operational waveform pulse.
DELAY	Computes the delay time of the identified operational waveform pulse.
WIDTH	Computes the width of the identified operational waveform pulse.

WAVEFORM CALCULATOR DESCRIPTIONS (Cont)

⑦ CURSOR POSITION (Duplicated on the measurement keyboard.)

CRS1< Moves Cursor 1, if on, toward the start of the operational waveform.

CRS1> Moves Cursor 1, if on, toward the end of the operational waveform.

CRS2< Moves Cursor 2, if on, toward Cursor 1.

CRS2> Moves Cursor 2, if on, toward the end of the operational waveform.

⑧ Numeric Entry

0 ... 9 Enters the designated digit into the X register.

. Enters the decimal point into the X register.

EEX Displays the exponent identifier and field in the X register.

CHS Changes the sign of the mantissa or exponent of the number being entered in the X register.

⑨ CURSORS

NOTE

The cursors, when on, are displayed on the operational waveform in the STORED and BOTH CRT DISPLAY modes as intensified points.

CRS2-1 Turns on both cursors. Displays the coordinates of Cursor 2 relative to Cursor 1. (Duplicated on the measurement keyboard.)

CRS1 Shift function of **CRS2-1**. Turns on Cursor 1 only. Displays the coordinates of Cursor 1 relative to the start of the waveform. (Duplicated on the measurement keyboard.)

HCRD Returns the horizontal coordinate (with one cursor on) or the relative horizontal coordinate (with both cursors on) to the X register.

>HCRD Shift function of **HCRD**. Moves the cursor(s), if on, so that the horizontal coordinate or relative horizontal coordinate equals the value in the X register.













VCRD Returns the vertical coordinate (with one cursor on) or the relative vertical coordinate (with both cursors on) to the X register.

>VCRD Shift function of **VCRD**. Moves the cursor(s), if on, so that the vertical coordinate, or relative vertical coordinate, equals the value in the X register.



OFF Turns off the cursors. (Duplicated on the measurement keyboard.)

WAVEFORM CALCULATOR DESCRIPTIONS (Cont)

⑩ DATA STORAGE

-  Returns the points-per-waveform setting to the X register.
-  Shift function of . Sets the points-per-waveform value to one of 128, 256, 512, or 1024.
-  Returns the vertical value of the operational waveform point specified in the X register to the X register.
-  Shift function of . Sets the operational waveform point specified in the X register to the vertical value given in the Y register.
-  Returns the constant to the X register from the constant register specified.
-  Shift function of . Copies the constant given in the Y register into the constant register specified in the X register.
-  Recalls the stored waveform specified in the X register from waveform memory to the display.
-  Shift function of . Copies the operational waveform into the waveform memory specified in the X register.







⑪ Shift Commands

-  Selects shift function of the next key pressed. (Duplicated on the measurement keyboard)
-  Shift function of  clears the shift flag.

⑫ STORED WFM DISPLAY

NOTE

The following commands affect the stored waveform displayed in the STORED or BOTH CRT DISPLAY modes only. They have no effect on the real-time waveforms or the displayed alphanumeric characters.

-  The stored waveform(s) are displayed with time as the horizontal axis (Y-T mode).
-  Shift function of . The stored waveform(s) are displayed in the X-Y mode using the waveform specified in the X register as the horizontal axis.
-  The stored waveform(s) are displayed as a series of points joined together with straight-line vectors.
-  Shift function of . The stored waveform(s) are displayed as a series of points.

WAVEFORM CALCULATOR DESCRIPTIONS (Cont)

- DSW** The stored waveform specified in the X register is displayed in addition to the operational waveform.
- CLW** Clears the stored waveform specified in the X register from the display if it was previously displayed with the DSW command.
- CLD** Shift function of **CLW**. Clears all waveforms, except the operational waveform, from the display if they were displayed with the DSW command.

13 VERTICAL POSITION

- VPUP** Moves the operational waveform upward.
- VPDN** Moves the operational waveform downward.

14 CRT DISPLAY (Duplicated on the measurement keyboard.)

- SCOPE** Selects real-time waveform and readout display mode.
- STORED** Selects stored waveform and character display mode.
- BOTH** Shift function of **STORED**. Selects mixed display of real-time and stored waveforms, with character display.

15 WFM ACQUISITION

- AQR** Acquires repetitive real-time waveform(s) with readout; stores result in waveform memory. (Duplicated on the measurement keyboard.)
- AQS** Shift function of **AQR**. Acquires single-sweep waveform(s) with readout, and stores the result in waveform memory. (Duplicated on the measurement keyboard.)
- AVG** Averages the repetitive real-time waveform the number of times listed in the X register and stores the result in waveform memory.
- GND** Presets ground reference for subsequent waveform acquisition. Ground reference is set at the algebraic mean vertical position of the real-time trace. (Duplicated on the measurement keyboard.)
- RDOUT** Shift function of **GND**. Returns the real-time readout value (without units) of the readout word specified in the X register to the X register.

16 ERROR (Indicator)—Illuminates when an error or warning condition occurs. (Duplicated on the measurement keyboard.)

WAVEFORM CALCULATOR DESCRIPTIONS (Cont)

17 WFM SCALING

VZR

Returns the location of the operational waveform's vertical zero reference (VZR) in divisions relative to the center horizontal graticule line to the X register.

VZR

Shift function of **VZR**. Moves the operational waveform so that its VZR is at the level specified in the X register.

VXPD

Vertically expands the operational waveform about the center horizontal graticule line by the factor specified in the X register. The vertical scale factor of the operational waveform is changed so that the waveform's value does not change. A negative number in the X register will also invert the operational waveform.

VSCL

Returns the vertical scale factor (size per vertical graticule division) of the operational waveform to the X register.

VSCL

Shift function of **VSCL**. changes the vertical scale factor of the operational waveform to the value specified in the X register.

HSCL

Returns the horizontal scale factor (size per horizontal graticule division) of the operational waveform to the X register.

HSCL

Shift functions of the **HSCL**. Changes the horizontal scale factor of the operational waveform to the value specified in the X register.

18 WFM FUNCTIONS

ITRP

Replaces a delimited portion of the operational waveform with a straight line. Delimiters are the cursors, if on, or the horizontal locations in the Y and X registers.

INTG

Integrates the operational waveform.

DIFF

Shift function of **INTG**. Differentiates the operational waveform.

ORD

Returns the value of the operational waveform at the horizontal position specified in the X register, to the X register.

ORD

Shift function of the **ORD**. Sets the operational waveform vertical value, at the value given in the Y register.

SMOOTH

Smooths the operational waveform (performs an n-point average) using the value in the X register.

HPLFT

Shift function of **SMOOTH**. Horizontally positions the operational waveform to the left.

WAVEFORM CALCULATOR DESCRIPTIONS (Cont)

- HXP** Horizontally expands the operational waveform, or the delimited portion of the operational waveform, by the value in the X register. The horizontal scale factor is changed by the expansion ratio to maintain the value of the operational waveform. The cursors, if on, are delimiters.
- HPRGT** Shift function of **HXP**. Horizontally positions the operational waveform to the right.

19 PROGRAM EXECUTE

NOTE

The following program commands, except STEP, are programmable.

- EXEC** Switches the processor and the display to the program Execute mode. This function is invoked with alternate actuations of the key.
- STEP** Switches the processor to the Step state and begins single-line execution of the program. This command is not programmable.
- RUN** Switches the processor from the idle state to the Run state.
- GSB** In the idle or Step states: move the execute pointer to the program line specified by the number in the X register for the start of the subroutine. In the Run state: moves the execute pointer to the specified line and continues execution of the subroutine.
- RTN** Shift function of **GSB**. In the idle or Step state: returns the execute pointer to the program line where the execute pointer was located prior to a GSB command. In the Run state: returns the execute pointer and continues execution.
- GOTO** In the idle or Step state: moves the execute pointer to the program line specified in the X register. In the Run state: moves the execute pointer to the specified line and continues execution.
- LBL** Shift function of **GOTO**. Returns the program line number to the X register of the first program line holding the specified label.
- IF Y > X** Compares the contents of the Y and X registers, and in the STORED or BOTH CRT DISPLAY modes, displays the test result if TRUE or FALSE.
- IF Y < X** Shift function of **IF Y > X**. Compares the contents of the Y and X registers and, in the STORED or BOTH CRT DISPLAY modes, displays the test result of TRUE or FALSE.

7854 Operators

WAVEFORM CALCULATOR DESCRIPTIONS (Cont)

START

Shift function of **RUN**. In the idle state: switches the processor to the Run state and begins execution with the first command of program line 000. In the Run state: continues execution with the first command of program line 000.

STOP

Terminates AOR, AVG, or GND if executing; terminates READ x , SEND x , >TEXT, TEXT, or SAVE prior to the start of data transfer; terminates program execution. (Duplicated on the measurement keyboard.)

PAUSE

Shift function of **STOP**. Stops execution for about 0.7 seconds.

BUSY (Indicator)—Illuminates when the processor is busy executing a command.

7854

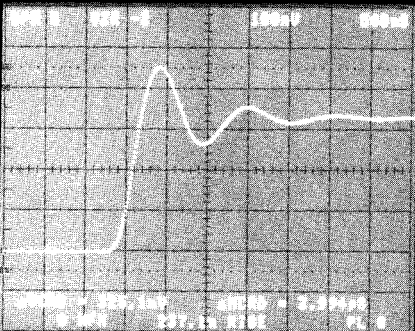
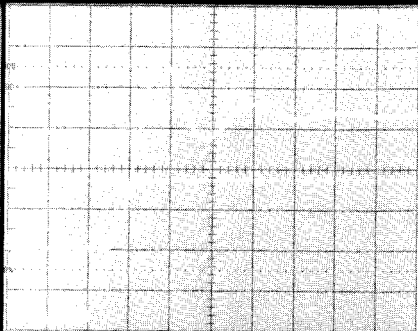
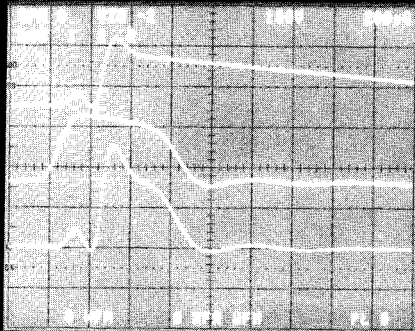

CRT DISPLAY

BOTH

STORED **SCOPE** **ID**

P **ER** **ER**

ID

ER

ER

f

ERROR

C

OFF

Introduction

The 7854 Oscilloscope system can be operated in any of three distinct display modes—SCOPE, STORED, or BOTH—as selected with the keys located in the CRT DISPLAY blocks on either the measurement or Waveform Calculator keyboards. These display modes are defined as follows: (a) SCOPE Mode—Real-time waveform and readout displays supplied by the selected plug-in units (as in conventional oscilloscopes). (b) STORED Mode—Stored waveform and alphanumeric character displays supplied by the internal processor of the 7854 Oscilloscope. (c) BOTH Mode—Mixed displays of the real-time waveforms from the plug-in units with the stored waveforms and alphanumeric character displays supplied from the internal processor.

Other features of your 7854 oscilloscope system are introduced in the remainder of this section. In addition, this section includes the following:

1. Brief descriptions of each control, connector, key, and indicator;
2. Installation instructions including power-up conditions; and
3. A glossary of terms used throughout this manual.

7854 FEATURES

The TEKTRONIX 7854 Oscilloscope with Waveform Calculator combines the features of a high-performance plug-in oscilloscope with a waveform-oriented dedicated-function digital processor.

The 7854 accepts Tektronix 7000-Series plug-in units for display control. The flexibility and variety provided by the wide line of plug-in units available allow the system to accommodate many measurement applications. The left pair of plug-in compartments are used for the vertical deflection of the real-time signal and the right pair are for the horizontal deflection. Electronic switching between each pair will produce multi-trace real-time vertical or horizontal displays.

In addition, the waveform processor provides equivalent-time sampled digitizing of waveforms to 400 megahertz equivalent-time bandwidth. The processor can be operated from either keyboard (front-panel measurement keyboard or detachable Waveform Calculator keyboard) or remotely over the GPIB (General Purpose Interface Bus). By changing the resolution of the waveform memory in the standard version of the 7854 Oscilloscope, up to 16 waveforms can be stored in memory; up to 9 of these can be displayed at one time. A mixed (BOTH) mode is provided to display both the real-time waveforms and the stored waveforms for comparison or measurement.

Cursors are provided for the stored waveforms to delimit or identify portions of the waveform to be measured. These cursors are generated by the processor and can be manually positioned by executing the appropriate commands from the keyboard(s), automatically positioned through execution of a stored program, or remotely positioned from the GPIB controller. Some of the dedicated functions (e.g., WIDTH, RISE, ITRP, etc.) are cursor-dependent. The cursor coordinates (or relative coordinates) are provided on the display in the STORED or BOTH modes.

Specific characteristics of the STORED display can be selected with the keyboards or over the GPIB. The Waveform Calculator provides display control to vertically or horizontally expand the stored waveform; display any stored waveform versus another in X-Y mode, or versus time in Y-T mode; display the stored waveform as individual points, or with vectors drawn between points. Also, functions are provided to manipulate the entire stored waveform. For example, any stored waveform can be either vertically or horizontally positioned without affecting the absolute voltage values; or any stored waveform can be differentiated, integrated, or smoothed and the resulting waveform displayed.

Programming, consisting of a series of commands stored for later execution, is available to simplify measurements which must be repeated. Editing and execution is controlled either from the Waveform Calculator or the GPIB.

INSTALLATION

This instrument was inspected both mechanically and electrically before shipment from the factory to be free of marks or scratches and to meet or exceed all electrical specifications. Upon receipt, inspect the instrument for any physical damage which may have been incurred in transit. Then, refer a qualified service person to the Performance Check Procedure in the Calibration section of the 7854 Service Manual to verify the electrical performance of the instrument. If mechanical damage or performance deficiencies are found, contact your local Tektronix Field Office or representative.

OPERATING POWER INFORMATION

This instrument will operate from either a 115-volt or 230-volt nominal line-voltage source, 48 to 440 hertz.

OPERATING VOLTAGE

The LINE VOLTAGE SELECTOR switch (located on the rear panel of the 7854 Oscilloscope mainframe) allows selection of 115-volt or 230-volt nominal line voltage operation. To select the correct nominal line voltage, first change the power cord and plug to match the power-source receptacle (if necessary). Then, use a small screwdriver to move the LINE VOLTAGE SELECTOR switch to the desired range.



To prevent damage to the instrument, always check the settings of the LINE VOLTAGE SELECTOR switch located on the rear panel of the 7854 Oscilloscope mainframe before connecting the instrument to the line-voltage source.

POWER CORD INFORMATION

A power cord with the appropriate plug configuration is supplied with each instrument. For your convenience the color-coding of the power cord conductors is given in Table 1-1. Also, should you require a power-cord plug other than that supplied, refer to the Power-Cord and Plug Identification Table 1-2.

WARNING

This instrument operates from a single-phase power source, and has a detachable three-wire power cord with a two-pole, three-terminal grounding-type plug. The voltage to ground (earth) from either pole of the power source must not exceed the maximum rated operating voltage, 250 volts.

Before making connection to the power source, determine that the instrument is adjusted to match the voltage of the power source, and has a suitable plug (two-pole, three-terminal, grounding type). Refer any changes to qualified service personnel.

This instrument is safety class I equipment (IEC designation). All accessible conductive parts are directly connected through the grounding conductor of the power cord to the grounding contact of the power cord. Therefore, the power plug must only be inserted in a mating receptacle with a grounding contact. Do not defeat the grounding connection. Any interruption of the grounding connection can create an electric shock hazard.*



For electric shock protection, the grounding connection must be made before making connection to the instrument's input or output terminals.

*International Electrotechnical Commission

TABLE 1-1
Power-Cord Conductor Identification

Conductor	Color	Alternate Color
Ungrounded (Line)	Brown	Black
Grounded (Neutral)	Light Blue	White
Grounding (Earthing)	Green/Yellow	Green/Yellow

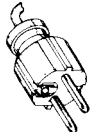
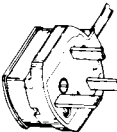
TABLE 1-2
Power-Cord And Plug Identification Information

Plug Configuration	Usage	Nominal Line-Voltage (AC)	Reference Standards	Option #
	North American 120V/15A	115 V	¹ ANSI C73.11 ² NEMA 5-15-P ³ IEC 83	STANDARD
	Universal Euro 250V/10-16A	230 V	⁴ CEE (7), II, IV, VII ³ IEC 83	A1
	UK 240V/13A	230 V	⁵ BS 1363 ³ IEC 83	A2
	Australian 240V/10A	230 V	⁶ AS C112	A3
	North American 240V/15A	230 V	¹ ANSI C73.20 ² NEMA 6-15-P ³ IEC 83	A4

¹ANSI—American National Standards Institute

²NEMA—National Electrical Manufacturer's Association

³IEC—International Electrotechnical Commission

⁴CEE—International Commission on Rules for the Approval of Electrical Equipment

⁵BS—British Standards Institution

⁶AS—Standards Association of Australia

MEMORY BACK-UP POWER

Two female banana jacks (on the rear panel of the 7854 Oscilloscope mainframe) allow application of about 6.25 V dc (≤ 0.7 A maximum) to provide back-up power for the volatile storage devices used for processor memory. The instrument is fuse protected for application of any voltages applied to the MEMORY BACK-UP POWER INPUT up to ± 50 volts (dc plus peak ac). When power is first applied to the MEMORY BACK-UP POWER INPUT the red indicator lights to indicate that the fuse has not blown.



To prevent loss of data from memory due to a power failure, apply memory back-up power.

OPERATING TEMPERATURE

The 7854 can be operated in ambient air temperatures between 0° and $+50^{\circ}$ C, and can be stored in ambient temperatures from -55° to $+75^{\circ}$ C. After being stored in temperatures outside the operating limits, allow the chassis temperature to return to within the operating limits before applying power.

The 7854 Oscilloscope mainframe is cooled by air drawn in through holes in the top, side, and bottom cabinet panels and blown out through the fan exhaust. To ensure proper instrument cooling, maintain the clearance provided by the feet on the bottom cabinet panel, and allow at least 2 inches of clearance at the top, sides, and rear of the instrument.

If the internal temperature of the mainframe exceeds a safe operating level, a thermal cutout will repeatedly disconnect the instrument power supply. This condition stops when the temperature returns to a safe level.

INSTALLING PLUG-IN UNITS

The 7854 Oscilloscope mainframe accepts up to 4 Tektronix 7000-series plug-in units. This feature allows selection of bandwidth, sensitivity, real-time display modes, etc., and provides for future expansion of the system.

The overall electrical capabilities of the system are mainly determined by the characteristics of the selected plug-ins. For information on other plug-in units, refer to the current Tektronix Products catalog.



To prevent instrument damage, plug-in units should not be installed or removed without first turning off the 7854 Oscilloscope. However, to prevent loss of data from memory, be sure memory back-up power is applied before turning off the instrument.

To install a plug-in unit into a compartment, align the slots in the top and bottom of the plug-in unit with the corresponding guide rails in the plug-in compartment. Insert the plug-in unit into the compartment until it locks into place. To remove a plug-in unit, pull out on the release latch to disengage the plug-in. To meet the EMC (electromagnetic compatibility) specifications, cover all unused plug-in compartments with an EMC-shielded blank plug-in panel, Tektronix part 016-0155-00.

The gain of the 7854 vertical and horizontal systems is normalized. This allows plug-in units to be interchanged among plug-in compartments without adjustment of the system. To verify plug-in accuracy, their basic calibration should be checked when installed. (Refer a qualified service person to the plug-in unit manual for further information).

CONNECTING THE WAVEFORM CALCULATOR



The 7854 Waveform Calculator is shipped to you in a package separate from the 7854 Oscilloscope mainframe. Upon receipt, inspect the Waveform Calculator for any physical damage which may have been incurred in transit. To attach the Waveform Calculator to the 7854 Oscilloscope, mate the connector at the end of the calculator cable to the rear-panel EXTERNAL KEYBOARD input on the mainframe. Then secure the connector with the screws provided on the outer edges of the cable connector.

GENERAL PURPOSE INTERFACE BUS (GPIB)

The 7854 (except Option 0D) is equipped with an IEEE 488-1978 Digital Interface for Programmable Instrumentation, commonly referred to as a General Purpose Interface Bus, or GPIB. The GPIB allows remote control of all processor functions, and data transfers to and from the 7854.

The GPIB connector and associated address and function selector switches are mounted on the rear panel of the 7854. Refer to the GPIB section of this manual for complete GPIB information.

POWER-UP CONDITIONS

When the 7854 is turned on (without memory back-up power applied), the waveform processor runs four self-checking tests. Although these tests are not all-inclusive, they indicate if major portions of the processor are properly working. The self-test sequence outlined below begins when power is applied to the 7854.

- Step 1:** When power is applied the following indicators will light: POWER, selected positions of the A and B TRIGGER SOURCE switches, and all selected indicators on the plug-in units. For approximately three seconds after power-up the following indicators will remain off: all positions of the VERTICAL and HORIZONTAL MODE switches, all Intensity indicators, all red front-panel (measurement keyboard) and Waveform Calculator indicators.
- Step 2:** All positions of the VERTICAL and HORIZONTAL MODE switches, all Intensity indicators, and all red front-panel and Waveform Calculator indicators will now light.
- Step 3:** A fault condition found through any of the four tests is indicated with the lights of the VERTICAL and HORIZONTAL MODE switches. Fault condition codes are listed in Table 1-3. Be sure to note the code received so that you may more fully inform the service person about the trouble.

TABLE 1-3
Self-Test Fault Codes

VERTICAL MODE Indicator Status	HORIZONTAL MODE Indicator Status	Circuitry With Fault
All lights on.	B light on.	RAM
All lights on.	CHOP light on.	ROM
All lights on.	CHOP and B lights on.	Real-time Clock
All lights on.	ALT light on.	Display

If a fault code occurs, press any button of the VERTICAL or HORIZONTAL MODE switches and the self-testing will continue. Then, refer a qualified service person to the Performance Check Procedure in the Calibration section of the 7854 Service Manual to verify the electrical performance of the instrument.

Step 4: Successful completion of the self tests is indicated by the issuance of the audible warning tone (if the rear-panel AUDIBLE ERROR/WARNING switch is ON), and the extinguishing of all red indicators, the S and A Intensity indicators, all VERTICAL MODE lights except LEFT, and all HORIZONTAL MODE switch lights except B. In addition, if the READOUT intensity control is set to about midrange, the message SELF TEST COMPLETE will be displayed on the crt.

PRESET CONDITIONS

After successful completion of the processor self tests, several parameters of the 7854 are set to predetermined conditions. These power-up conditions are:

- CRT DISPLAY Mode Set to SCOPE
- Program Mode Set to EXECUTE
- Program Memory Cleared
- VERTICAL MODE Set to LEFT
- HORIZONTAL MODE Set to B
- Stored Waveform Display Not displayed;
set to VECTors
- P/W (Points/Waveform) Set to 512
- Stack Registers Cleared to 0
- OPW (Operational Waveform) Set to 0
- All Waveform Memory Points Set to the zero value
(center horizontal graticule line)
- VZR (Vertical Zero Reference) Set to 0 (all
waveform memories)
- Vertical Scale Factor Set to 1 (all
waveform memories)
- Vertical Scale Factor Unit Set to V (all
waveform memories)
- Horizontal Scale Factor Set to 1 (all
waveform memories)
- Horizontal Scale Factor Unit Set to S (all
waveform memories)
- Constant Registers Set to 0
- TTL Output Set HIGH
- All GPIB Service-Request Functions Set ON

OPERATING POSITION

A bail-type stand, mounted on the bottom of the mainframe, permits the instrument to be tilted up about 10° for more convenient crt viewing.

GLOSSARY OF TERMS

The terms listed in this glossary are used throughout this manual and are defined here for your convenience.

ADDRESS

A value that identifies a specific storage location.

ALGORITHM

A fully specified procedure used for solving a mathematical problem in a finite number of steps.

ASCII

Abbreviation for "American Standard Code for Information Interchange". A seven-bit character code used extensively in data transmission in which 128 numerals, letters, symbols, and special control codes are represented.

AUTOSCALE

Automatic vertical scaling of a stored waveform to maximize the display range to between ± 3.5 divisions from center screen.

BITS

A single entity used to encode data and designated by either 0 or 1.

BUS

An interface of one or more signal lines used to connect two or more devices over which messages are transferred.

BYTE

A unit of 8 bits used to encode data. The data transfers over the GPIB are byte serial, bit parallel.

CALCULATOR LANGUAGE

A computer language that consists primarily of commands, each of which is capable of invoking a function to be executed.

COMMAND

An instruction which initiates the processor to perform a pre-programmed function.

COMMAND BUFFER

A device for storing incoming commands, in order of arrival, while previously received commands are being executed by the processor.

CONSTANT

In the 7854 a constant is a single-valued variable.

CONSTANT REGISTER

A storage register which is able to hold only one constant at a time.

Option	Number CNS Registers	CNS Number
ØD	Ø	—
Standard ¹	5Ø	Ø-49
2D ¹	1ØØ	Ø-99

CONTROLLER

A device on the GPIB which is in charge of establishing talkers and listeners for data transfers.

CURSORS

One or two specially identified points on the operational waveform used to delimit or identify for further waveform manipulation or measurement.

CURVE

An ASCII string used to represent actual waveform data points over the GPIB.

DATA PATH

Refer to Figure 1-1 for illustrated definition.

DIGIT

One of the symbols: Ø,1,2,3,4,5,6,7,8, and 9.

DIGITIZER

A device which converts analog data into numbers. In the 7854 the digitizer converts the real-time signals into the digitally-represented stored waveforms.

DOTS

A mode used to represent and display the stored waveforms as a series of discrete points.

EDIT

To modify the stored program, e.g., to insert or delete commands into or from a program.

EQUIVALENT TIME

In digitizing oscilloscope operation: the time scale associated with the output of the digitizer.

EQUIVALENT-TIME BANDWIDTH

The range of frequencies which can be adequately digitized.

¹ Applies only to instruments with serial numbers below B085121. For instruments with serial number B085121 and above, features previously provided by Option 2D are standard.

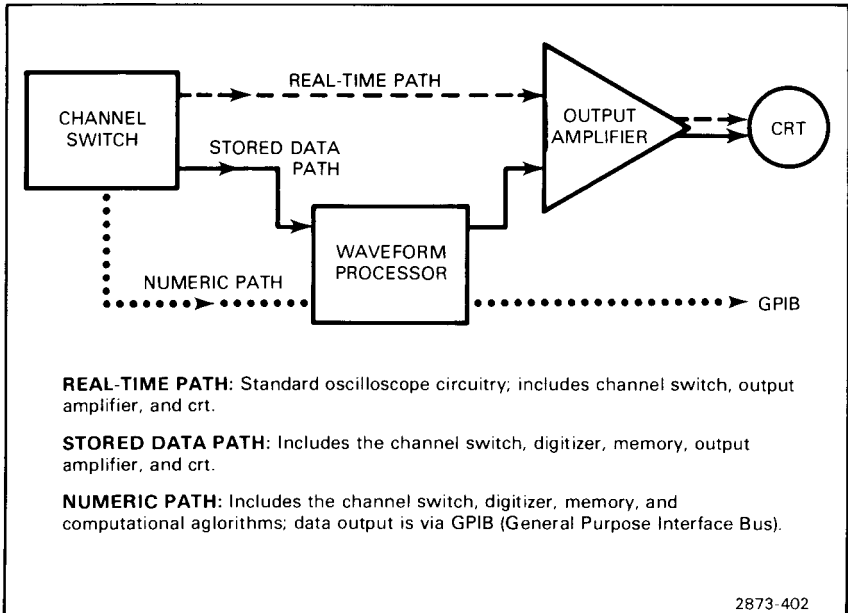

Figure 1-1. Definition of Data Path Terms.

EQUIVALENT-TIME SAMPLING

The method used to digitize and store repetitive real-time waveforms in the 7854 whereby a stored waveform is built from samples taken during many cycles of a repetitive real-time waveform.

ERROR

Issued when the command which was to be executed could not be executed because a restriction condition existed.

ESIGN

The sign (either + or -) associated with the exponent.

EVALUE

The absolute value of the exponent.

EXECUTION

Performing a command.

EXPONENT

A signed two-digit number that indicates the power to which the base (10) is raised.

FIELD

A specified area of the graticule used to display a particular category of data, (e.g. the contents of the X register, the mnemonic of the last command executed, etc.).

FLAG

A character that signals the occurrence of some condition, such as the *f* indicates that a shift function will follow.

FLOATING-POINT

In the 7854: a form of notation in which quantities are expressed as a mantissa (within the range of 1.000 through 999.9) with an exponent.

FUNCTION

A statement to the processor that specifies the operation to be performed. In the 7854 the values or locations of the operands are implicit in the function.

GPIB

The abbreviation for General Purpose Interface Bus which is defined by the IEEE standard 488-1978.

GPIB-ONLY COMMANDS

Commands accessible only via the external interface; commands having no corresponding keys.

HANDSHAKE

A method of transferring data over the GPIB involving an interlocked sequence of signals (e.g., DAV, NRFD, NDAC, etc.).

INTERRUPT

To stop a process in such a way that it can be resumed.

I/O (Input/Output)

A term used to refer to data transfers between devices.

JITTER

Instability of a displayed signal in either amplitude or phase.

LABEL

In the 7854 a label consists of the character "L" followed by two digits that serve to identify a program line.

LISTENER (or Acceptor)

A device on the GPIB which is receiving data from another device on the GPIB. Several listeners are allowed for any data transfer.

LETTER EXPONENT

A single letter following the mantissa of a displayed floating-point number which represents a power of 10 multiplier (e.g., in 2.467m the m represents $E-03$).

LSD

Abbreviation for "least significant digit", which is the digit with the lowest weighting in a number. Usually the right-most digit.

MAINFRAME

That portion of the 7854 which houses the plug-in units and the majority of circuitry. Does not include the Waveform Calculator or the specific plug-in units.

MANTISSA

That portion of a floating-point number representing the significant digits of the number (e.g., 2.460 is the mantissa in the number: 2.460E+29).

MEASUREMENT KEYBOARD

The keys and associated indicators located on the front panel of the 7854 mainframe.

MESSAGE TERMINATOR

A means of specifying the last byte to be transferred over the GPIB in any one message.

MNEMONIC CODE

Symbolic language codes that are easily remembered because they closely resemble the operation that they specify. All 7854 mnemonics are briefly defined below:

ABS	Compute and return absolute value to the X register.
AQR	Acquire repetitive waveform(s).
AQS	Acquire single-shot waveform(s).
AREA	Compute and return OPW area.
AVG	Average the real-time waveform.
AVG10	Average the real-time waveform 10 times.
AVG100	Average the real-time waveform 100 times.
AVG1000	Average the real-time waveform 1000 times.
BOTH	Set display mode for both real-time waveforms and stored waveforms.

MNEMONIC CODE (Cont)

CEROFF*	Turn off service requests for command errors. (Issued only over GPIB.)
CERON*	Turn on service requests for command errors. (Issued only over GPIB.)
CHS	Change sign.
CLD	Clear the stored display of all stored waveforms displayed with the DSW command.
CLf	Clear shift flag.
CLL	Clear program line.
CLP	Clear entire program memory.
CLS	Clear stack.
CLW	Clear the designated stored waveform from the display.
CLX	Clear X register by popping the stack.
CNS	Return value from constant register.
CNS	Store value in constant register.
CRS1	Turn Cursor 1 on.
CRS1<	Move Cursor 1 toward start of OPW.
CRS1>	Move Cursor 1 toward end of OPW.
CRS2-1	Turn both cursors on.
CRS2<	Move Cursor 2 toward Cursor 1.
CRS2>	Move Cursor 2 toward end of OPW.
DELAY	Compute and return delay time.
DIFF	Differentiate the OPW.
DOTS	Display stored waveform(s) in DOTS mode.
DSW	Display the designated stored waveform.

*These mnemonics are not printed on the instrument.

 MNEMONIC CODE (Cont)

EEX	Enter exponent.
ERR?*	Transmit error status over GPIB.
ENERGY	Compute and return energy.
ENTER	Enter data in stack; terminates numeric entry or pushes the stack.
EXECUTE	Go to the program Execute mode.
EXP	Compute exponential function.
EXROFF*	Turn off service requests for execution errors. (Issued only over GPIB.)
EXRON*	Turn on service requests for execution errors. (Issued only over GPIB.)
<i>f</i>	Set shift flag.
FALL	Compute and return fall time of OPW pulse.
FREQ	Compute and return frequency of OPW.
GND	Set ground reference.
GOTO	Go to specified program line.
GSB	Go to program subroutine.
HCRD	Return cursor(s) horizontal coordinate.
>HCRD	Set horizontal coordinate of cursor(s).
HMDA*	Set HORIZONTAL MODE to A.
HMDALT*	Set HORIZONTAL MODE to ALT.
HMDB*	Set HORIZONTAL MODE to B.
HMDCHOP*	Set HORIZONTAL MODE to CHOP.
HPLFT	Horizontally position the OPW left.
HPRGT	Horizontally position the OPW right.

*These mnemonics are not printed on the instrument.

MNEMONIC CODE (Cont)

HSCL	Return OPW horizontal scale factor.
HSCL	Set OPW horizontal scale factor.
HXPB	Horizontally expand the OPW.
ID	Display instrument identify message.
ID *	Transmit instrument identify message over the GPIB.
INTG	Integrate OPW.
ITRP	Linearly interpolate.
IFX=I	Compare constants or referenced waveforms in X and Y registers for equality.
IFY>X	Compare constants or referenced waveforms in Y and X register for "greater than" condition.
IOCOFF*	Turn off service requests for I/O commands. (Issued only over the GPIB.)
IOCON*	Turn on service requests for I/O commands. (Issued only over the GPIB.)
LBL	Return labeled program line number.
LN	Compute and return natural logarithm.
LNN	Begin entering program line label.
MAX	Compute and return maximum value of OPW.
MEAN	Compute and return mean value of OPW.
MID	Compute and return middle value of OPW.
MIN	Compute and return minimum value of OPW.
NEXT	Advance to next program line.
OFF	Turn cursor(s) off.
OPCOFF*	Turn off service requests for operation complete. (Issued only over the GPIB.)

*These mnemonics are not printed on the instrument.

MNEMONIC CODE (Cont)

OPCON*	Turn on service requests for operation complete. (Issued only over the GPIB.)
ORD	Return ordinate (vertical) value of specified horizontal coordinate of OPW.
-ORD	Set OPW to specified ordinate value at specified horizontal coordinate.
PAUSE	Pause temporarily in program execution.
PER	Compute and return period of OPW.
PNT	Return value of specified point of OPW.
-PNT	Set point of OPW to specified value.
P-P	Compute peak-to-peak value of OPW.
PREV	Back up to previous program line.
PROG	Enter programming mode.
P/W	Return points-per-waveform setting.
-P/W	Set the points-per-waveform of all waveform memories.
READX	Input data into 7854 X register from GPIB.
REMOFF*	Turn off service requests for RQS. (Issued only over the GPIB.)
REMON*	Turn on service requests for RQS. (Issued only over the GPIB.)
RDOUT	Return real-time readout word contents.
RISE	Compute and return rise time of OPW.
RMS	Compute and return root-mean-square of OPW.
ROLL	Shift data circularly within the stack.
RQS	Transmit SRQ query request.
RQSOFF*	Turn off all service requests except Power On. (Issued only over the GPIB.)

*These mnemonics are not printed on the instrument.

MNEMONIC CODE (Cont)

ROSON*	Turn on all service requests (under most conditions and is issued only over the GPIB).
RTN	Return from program subroutine.
RUN	Run program beginning with the first command of the current program line.
SAVE	Transmit program over GPIB.
SCOPE	Set display mode to SCOPE.
SEND	Transmit constant or referenced waveform from the 7854 X register over GPIB.
SIGN	Compute and return signum function.
SMOOTH	Smooth OPW.
SQRT	Compute and return square root.
SQR?*	Transmit display line 16 over GPIB.
START	Execute program from start (first command of line 000).
STEP	Single-line program execution.
STOP	Terminate program or command execution or equivalent-time sampling acquisition.
STORED	Set display mode to STORED.
SWH	Set TTL SIGNAL OUTPUT to high.
TLV	Set TTL SIGNAL OUTPUT to low.
TEXT*	Transmit displayed alphanumeric characters over GPIB. (Issued only over the GPIB.)
>TEXT*	Input alphanumeric characters to display from GPIB. (Issued only over the GPIB.)
TIME	Display waveform versus time (Y-T mode).
VCRD	Return cursor(s) vertical coordinate.
VCRD*	Set cursor(s) vertical coordinate.

*These mnemonics are not printed on the instrument.

 MNEMONIC CODE (Cont)

VECT	Display stored waveform(s) in vector mode.
VMDADD*	Set VERTICAL MODE to ADD.
VMDALT*	Set VERTICAL MODE to ALT.
VMDCHOP*	Set VERTICAL MODE to CHOP.
VMDL*	Set VERTICAL MODE to LEFT.
VMDR*	Set VERTICAL MODE to RIGHT.
VPDN	Move OPW down.
VPUP	Move OPW up.
VS	Display waveform versus waveform (X-Y mode).
VSCL	Return OPW vertical scale factor.
>VSCL	Set OPW vertical scale factor.
VXPD	Vertically expand the OPW.
VZR	Return the vertical zero reference of the OPW.
>VZR	Set the OPW vertical zero to the specified graticule location.
WFM	Return and display specified stored waveform.
>WFM	Store OPW into specified waveform memory.
WIDTH	Compute and return width.
$x \leftrightarrow y$	Exchange contents of X and Y registers.
+	Add.
-	Subtract.
*	Multiply.
/	Divide.
.	Decimal point.
0-9	Digits.

*These mnemonics are not printed on the instrument.

MSD

Abbreviation for "most significant digit", which is the digit with the highest weighting in a number. Usually the left-most digit.

NESTING

A programming technique involving the calling of subroutines from other subroutines.

NOISE

A term referring to spurious or undesirable electrical signals.

OPERAND

Any quantity that is used as input for a command and affects its results.

OPERATIONAL WAVEFORM (OPW)

The operational waveform is always displayed in the stored mode, and is the only stored waveform whose scale factors are displayed. It is the waveform operand for certain waveform functions and the cursors are associated with it. The operational waveform is the one whose number is presently in the X register, and is the default stored waveform which is currently being manipulated or operated upon.

PREAMBLE

An ASCII string used to define the scaling information for a waveform transferred over the GPIB.

PROGRAM

A set of stored commands that specifies the series of functions to be automatically performed by the processor.

PROGRAM LINE

A set of commands which reside on one line of a program, each line having a unique line number.

POPPING THE STACK

A method of removing data from the stack whereby the data is retrieved from the X register.

PUSHING THE STACK

A method of entering new data into the stack whereby the new data is written into the X register.

QUANTIZE

To convert a continuous variable, such as a real-time waveform, into a series of specified steps or levels. There are no "in-between" values in such a quantized waveform. Each value of signal is replaced by the nearest available level.

QUERY

A GPIB output command used to get status information beyond that contained in the status byte.

RAM

Abbreviation for "random-access memory". A memory that can be both written into and read from.

REAL-TIME WAVEFORMS

Having to do with the actual time during which physical events take place; usually used to refer to conventional oscilloscope displays.

REAL-TIME SAMPLING

The method used to sequentially digitize and store single-sweep waveforms in the 7854.

RETURN

A bringing back of data from the memory to the stack. Also, means "returns execution control from a subroutine to the calling program".

ROM

Abbreviation for "read-only memory". A storage arrangement primarily for information-retrieval applications. A memory that can only be read from, not written into.

ROUNDING

Method used to modify a number which contains more significant digits than can be preserved. Numbers in the 7854 are rounded to 4 significant digits.

RPN

Abbreviation for "reverse polish notation". An arithmetic system used by the 7854 whereby the operand(s) are specified before the function.

rsv

IEEE STD 488-1978 local message indicating request service.

SCALE FACTOR

The factor by which the number of scale divisions indicated must be multiplied to compute the vertical deflection or sweep duration.

SRQ

IEEE STD 488-1978 remote message indicating service request.

SERIAL POLL

A sequential method used by the GPIB controller to receive status from other devices on the GPIB.

STACK

A storage area reserved for temporarily holding constant operands or results, or referencing waveforms in waveform memory, and consisting of five registers named W, T, Z, Y, and X.

STORING

The entire procedure, performed under control of the processor, to place data in memory.

SUBROUTINE

A series of instructions that perform a specific task and are only a portion of the main program. Primarily used to prevent duplication of code in programs.

TALKER (or Source)

A device on the GPIB which is transferring data to other devices on the GPIB. Only one talker is allowed for any data transfer.

TRUNCATE

The dropping of digits from one end of a data item, usually the least significant end, causing loss of precision or information.

VECTOR

A mode used to represent and display the stored waveforms as a series of straight-line segments between two time-adjacent points.

VOLATILE STORAGE

A storage device in which stored data are lost when power is removed.

WARNING

Issued when the results from the command executed may not be what the user expects. The results should be examined carefully.

WAVEFORM PROCESSOR

Part of the 7854 which contains the waveform and program storage, arithmetic unit, and special register groups. It performs arithmetic operations, controls instruction execution, and provides timing signals and other housekeeping operations. Also referred to as the processor.

7854

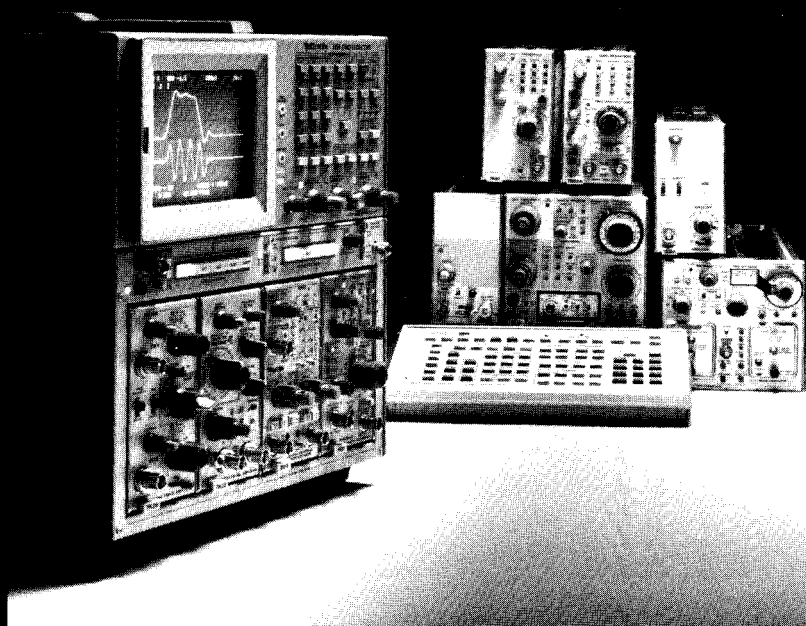

Specification

This Specification section contains tabular listings of the Electrical, Environmental, and Physical Characteristics of the 7854 Oscilloscope with Waveform Calculator.

Refer a qualified service person to the Performance Check Procedure in the Calibration section of the 7854 Service Manual to verify the electrical performance of your instrument.

Also included in this section are:

1. Instrument shipping instructions;
2. A list of standard accessories for the 7854 Oscilloscope;
3. The 7000-series oscilloscope system specifications; and
4. A table of plug-in unit compatibilities.

7854 MAINFRAME AND WAVEFORM CALCULATOR SPECIFICATIONS

The electrical characteristics listed in Table 2-1 apply when the following conditions are met: (1) Calibration of the instrument must have taken place at an ambient temperature between $+20^{\circ}$ and $+30^{\circ}$ C, (2) the instrument must be allowed a 20-minute warm-up period, (3) all specifications are valid at an ambient temperature of 0° to $+50^{\circ}$ C, unless otherwise stated, and (4) the instrument must be in an environment that meets the limits described in Table 2-2.

Any applicable conditions not listed above are expressly stated as part of that characteristic. Environmental Characteristics are listed in Table 2-2 and Physical Characteristics are listed in Table 2-3.

TABLE 2-1
Electrical Characteristics

Characteristic	Performance Requirement
REAL-TIME VERTICAL SYSTEM	
Deflection Factor as Checked With 067-0587-02 Calibration Fixture, Referenced to 6 Div	Compatible with all 7000-series plug-in units.
Difference Between Vertical Channels	1%, or less.
Low-Frequency Linearity	0.1 div, or less, compression or expansion of a center-screen 2 div signal repositioned vertically anywhere within the graticule area.
System Bandwidth	Varies with plug-in unit selected. See 7000-Series Oscilloscope Systems Specification at the end of this section.
Step Response System Rise Time	Varies with plug-in unit selected. See 7000-Series Oscilloscope Systems Specification at the end of this section.
Channel Isolation All Vertical Modes (Except ADD)	At least 100:1 from dc to 250 MHz; and at least 40:1 from 250 MHz to 475 MHz.

TABLE 2-1 (CONT)
Electrical Characteristics

Characteristic	Performance Requirement
REAL-TIME VERTICAL SYSTEM (Cont)	
Delay Line	Permits viewing the leading edge of triggering signal.
Displayed Difference in Signal Delay Between Vertical Channels	
Externally Triggered	60 ps, or less.
Internally Triggered	200 ps, or less.

REAL-TIME HORIZONTAL SYSTEM

Deflection Factor as Checked With 067-0587-02 Calibration Fixture	Compatible with all 7000-series plug-in units.
Difference Between Horizontal Channels	1%, or less.
Linearity at 1 ms/Div	0.05 div, or less, error at each graticule line after adjusting for no error at the second and tenth graticule lines.
Fastest Calibrated Sweep Rate	500 ps/div.
Horizontal Bandwidth Referenced to 10 Div of 50-kHz	Dc to at least 1 MHz (-3 dB).
Phase Shift Between Vertical and Horizontal Systems	2°, or less, from dc to at least 35 kHz.
With Option 02 (B HORIZ Compartment Only)	2°, or less, from dc to 1 MHz.

DIGITIZER

Vertical Acquisition Window	From +5 div above, to -5 div below the center horizontal graticule line.
-----------------------------	--

TABLE 2-1 (CONT)
Electrical Characteristics

Characteristic	Performance Requirement
DIGITIZER (Cont)	
Vertical (cont)	
Resolution: Stored and Numeric Data Paths ¹	Nominally 0.0098 div.
Noise: Numeric Data Path ¹	0.008 div or less, mean value of 100 rms measurements, mainframe only.
DC Gain Accuracy as Checked With 067-0587-02 Calibration Fixture, Referenced to 6 Div	
Stored and Numeric Data Paths ¹	Within 1% at temperature of calibration.
Change With Temperature	0.8%, or less, per 10° C.
DC Offset	
Stored Data Path ¹	Within 0.2 div of real time waveform, at temperature of calibration.
Numeric Data Path ¹	Within 0.1 equivalent graticule div of zero, at temperature of calibration.
Change With Temperature	0.1 div, or less, per 10° C.
System Bandwidth: Stored and Numeric Data Paths ¹	Varies with plug-in unit selected. See 7000-Series Oscilloscope Systems Specification at the end of this section; bandwidth shall be same specification limits as given for real-time operation.
Matching To Real Time	Real time and acquisition system sine-wave amplitude response should match each other to within $1+[2.5(f/100 \text{ MHz})]\%$, where $0 \leq f \leq 400 \text{ MHz}$, (f in MHz).

¹Refer to Figure 1-1 in Section 1, Introduction.

TABLE 2-1 (CONT)
Electrical Characteristics

Characteristic	Performance Requirement
DIGITIZER (Cont)	
Vertical (cont)	
System Step Response: Stored and Numeric Data Paths ¹	Varies with plug-in unit selected. See 7000-Series Oscilloscope Systems Specification at the end of this section; step response shall be same specification limits as given for real-time operation.
Horizontal	
Acquisition Window	From -5 div left, to +5 div right of the center vertical graticule line.
Resolution: Stored and Numeric Data Paths ¹	Nominally: 0.0098 div at 1024 P/W; 0.0196 div at 512 P/W; 0.0392 div at 256 P/W; 0.0784 div at 128 P/W;
Noise: Numeric Data Path ¹	0.01 div or less, mean value of 100 rms measurements, mainframe only.
DC Gain Accuracy, as Checked With 067-0587-02 Calibration Fixture, Referenced to 6 Div	
Stored and Numeric Data Path ¹	Within 1% at temperature of calibration.
Change With Temperature	0.4%, or less per 10° C.
DC Offset	
Stored Data Path ¹	Within 0.1 div of graticule center, at temperature of calibration.
Numeric Data Path ¹	Within 0.1 equivalent graticule div of zero, at temperature of calibration.
Change With Temperature	0.1 div, or less, per 10° C.

¹Refer to Figure 1-1 in Section 1, Introduction.

TABLE 2-1 (CONT)
Electrical Characteristics

Characteristic	Performance Requirement	
DIGITIZER (Cont)		
Equivalent Time Sampling	For proper acquisition, input signals must be repetitive single-valued waveforms of the horizontal variable. Processor does not check that these conditions are met.	
Maximum Sweep Speeds for Single-Shot Acquisition with 7B87 Time Base with Pre-trigger Acquire Clock (For Dual Trace Use Next Slower Sweep Speed)	P/W	Maximum Sweep Speed (μ s/div)
	128	50
	256	100
	512	200
1024	500	

CRT SYSTEM

Graticule Type	Internal; illuminated with variable edge lighting.	
	Display Area	8 div vertically by 10 div horizontally.
	Div Unit	1 div = 1 cm.
Phosphor Standard	P31.	
	Option 78 P11.	
Photographic Writing Speed (With Polaroid 3000 ASA Film, Without Film Fogging P-11 Phosphor) TEKTRONIX C51 Camera, f1.2 Lens and 1:0.5 Object-to-Image Ratio	At least 2.5 cm/ns. Photograph is viewed with front illumination. In typical applications, P31 phosphor has approximately one-half the writing speed of P11 phosphor.	

TABLE 2-1 (CONT)
Electrical Characteristics

Characteristic	Performance Requirement
EXTERNAL CONNECTORS	
Camera Power	Front-panel 3-contact connector (on crt bezel) compatible with Tektronix C-50 series cameras.
Bottom Pin	Ground.
Center Pin	Single-sweep reset.
Top Pin	+15 V.
CALIBRATOR Output	Front-panel bnc connector.
Wave Shape	Square wave.
Polarity	Positive-going with baseline at 0 V.
Output Resistance	450 Ω .
Output Voltage	(Selected by front-panel CALIBRATOR switch.)
Load ≥ 100 k Ω	40 mV, 0.4 V, 4 V.
Load = 50 Ω	4 mV, 40 mV, 0.4 V.
Accuracy	Within 1%.
Output Current	40 mA available through CALIBRATOR output with a bnc-to-current loop adapter. CALIBRATOR switch must be set to 4 V for calibrated output.
Repetition Rate	1.0 kHz, within 0.25%.
Duty Cycle	49.8% to 50.2%.
Rise Time and Fall Time (100 pF maximum load)	250 ns or less.
Ground post	Provides convenient user ground reference point on front panel.

TABLE 2-1 (CONT)
Electrical Characteristics

Characteristic	Performance Requirement
EXTERNAL CONNECTORS (Cont)	
EXTERNAL KEYBOARD	25-pin female rear-panel connector for connecting an external keyboard.
GPIB IEEE-488-1978	24-pin female rear-panel connector for connecting instrument to GPIB. Meets IEEE 488-1978. (Not available on Option 0D).
MEMORY BACK-UP POWER	Two rear-panel female banana jacks. Provides connections for external power to maintain power on RAM, thereby providing non-volatile memory.
Voltage Requirement	6.0 to 6.5 V dc.
TTL SIGNAL OUTPUT SWL/SWH	Rear-panel bnc connector provides TTL-compatible signal.
Output Level	Set by user commands available on the Waveform Calculator.
SWL Command	Selects low level output (between 0 V and +0.8 V). Maximum current sink is 16 mA.
SWH Command	Selects high level output (between +2.4 V and +5.0 V). Maximum current source is 2.6 mA.
+SAWTOOTH OUT	Rear-panel bnc connector.
Polarity	Positive-going with baseline at 0 V, within 1 V, into 1 M Ω load.
Output Voltage	10 V maximum.
Rise Time Into 50 Ω	50 mV/unit-of-time, selected by the time-base unit time/div switch, within 15%; 100 ns/div maximum.
Rise Time Into 1 M Ω	1 V/unit-of-time, within 10%, selected by the time-base unit time/div switch; 1 μ s/div maximum.
Output Resistance	Approximately 950 Ω .

TABLE 2-1 (CONT)
Electrical Characteristics

Characteristic	Performance Requirement
EXTERNAL CONNECTORS (Cont)	
+GATE OUT	Rear-panel bnc connector.
A Gate	Derived from A HORIZ time-base unit main gate.
B Gate	Derived from B HORIZ time-base unit main gate.
Dly'd Gate	Derived from A HORIZ time-base unit delayed gate.
Polarity	
A or B Gate	Positive-going with baseline at 0 V, within 1.0 V, into 1 MΩ load.
A Dly'd Gate	Positive level when A time-base delayed sweep or B sweep is enabled; 0 V, within 1.0 V, into 1 MΩ load, when sweeps are disabled. Output is positive when no plug-in is used or when plug-in does not provide delay gate.
Output Voltage	10 V maximum.
Into 50 Ω Load	0.5 V, within 10%.
Into 1 MΩ Load	10 V, within 10%, (up to 1 μs/div).
Rise Time Into 50 Ω	20 ns or less.
Output Resistance	Approximately 950 Ω.
SIGNAL OUT	Rear-panel bnc connector selected by A TRIGGER SOURCE switch.
Source	Same as A TRIGGER SOURCE.
Output Voltage	±15 V maximum.
Into 50 Ω Load	Approximately 25 mV/div of vertical deflection.

TABLE 2-1 (CONT)
Electrical Characteristics

Characteristic	Performance Requirement
EXTERNAL CONNECTORS (Cont)	
SIGNAL OUT (cont)	
Output Voltage (cont)	
Into 1 M Ω Load	Approximately 0.5 V/div of vertical deflection.
Bandwidth Into 50 Ω Load (-3 dB)	Varies with vertical plug-in selected. See 7000-Series Oscilloscope Systems Specifications at the end of this section.
DC Centering	0 V, within 1 V, into 1 M Ω load.
Aberrations	15% p-p, or less, within 50 ns of step.
Output Resistance	Approximately 950 Ω .
Z-AXIS INPUT	Rear-panel bnc connector.
Polarity and Sensitivity	+2 V provides complete blanking from maximum intensity condition; -2 V provides complete unblanking from minimum intensity condition.
Low-Frequency Limit	Dc.
Input Resistance	Approximately 470 Ω .
Input Capacitance	Less than 50 pF.
Open Circuit Voltage	Approximately 0 V.
Maximum Input Voltage	15 V (dc plus peak ac).
Maximum Repetition Rate	1 MHz.
SINGLE SWEEP RESET	Rear-panel bnc connector.
Input	Input to reset single-sweep function of time-base units installed in A and B HORIZ compartments.

TABLE 2-1 (CONT)
Electrical Characteristics

Characteristic	Performance Requirement
EXTERNAL CONNECTORS (Cont)	
SINGLE SWEEP RESET (cont)	
Signal Required	Closure to ground (or switching from the high level to the low level in less than 1 ms) resets the sweep.
High Level	+50 V to +10 V, sink less than 40 μ A.
Low Level	+0.5 V to -5 V, sink less than 10 mA.
Minimum Pulse Width	10 μ s at 50% amplitude points.
Maximum Input Voltage	+50 V to -5 V (dc plus peak ac).
AC Power Input	3-pin male connector.

GPIB INTERFACE

Functions Implemented (As Per IEEE 488-1978)	Description:
SH1	Complete Source Handshake.
AH1	Complete Acceptor Handshake.
T5	Talk Function.
L3	Listen Function.
SR1	Complete Service Request Capability.
RL1	Complete Remote/Local Capability.
PP0	No Parallel Poll Capability.
DC1	Complete Device Clear Capability.
DT1	Complete Device Trigger Capability.
C0	No Controller Capability.

TABLE 2-1 (CONT)
Electrical Characteristics

Characteristic	Performance Requirement
COMMAND ACCURACY	
NOTE	
<i>All keyboard commands not listed below do not contribute accuracy errors, with exception of the >VCRD command. Refer to Section 9, Command Language, for additional information.</i>	
Waveform Functions	
Arithmetic Functions	
SQRT LN EXP SGN +, -, /, *	Accurate to 4 significant digits $\pm(6 * 10^{-4}) * (VSCL)$.
Cursors Functions	
HCRD	Accurate to 4 significant digits $\pm(6 * 10^{-5}) * (HSCL)$.
VCRD	Accurate to 4 significant digits $\pm(6 * 10^{-5}) * (VSCL)$.
Data Storage Functions	
PNT	Accurate to 4 significant digits $\pm(6 * 10^{-5}) * (VSCL)$.
>PNT	Accurate to 4 significant digits $\pm(6 * 10^{-4}) * (VSCL)$.
Wfm Functions	
ORD SMOOTH DIFF ITRP INTG	Accurate to 4 significant digits $\pm(6 * 10^{-5}) * (VSCL)$.

TABLE 2-1 (CONT)
Electrical Characteristics

Characteristic	Performance Requirement
COMMAND ACCURACY (Cont)	
Waveform Functions (cont) Wfm Functions (cont)	Accurate to 4 significant digits $\pm(6 * 10^{-4}) * (VSCL)$. If autoscaling occurs, all waveform points are rescaled to: $\pm(6 * 10^{-4}) * (VSCL)$.
Wfm Parameters MAX MIN P-P MID MEAN RMS	Accurate to 4 significant digits $\pm(6 * 10^{-5}) * (VSCL)$.
ENERGY	Accurate to 4 significant digits $\pm(6 * 10^{-5}) * (VSCL^2) * (HSCL)$.
AREA	Accurate to 4 significant digits $\pm(6 * 10^{-5}) * (VSCL) * (HSCL)$.
	Accurate to 4 significant digits $\pm(6 * 10^{-4}) * (HSCL)$.
DELAY WIDTH RISE PER	Accurate to 4 significant digits $\pm(6 * 10^{-4}) * (HSCL)$.
Wfm Scaling Functions VZR VSCL	Accurate to 4 significant digits $\pm(6 * 10^{-5}) * (VSCL)$.

TABLE 2-1 (CONT)
Electrical Characteristics

Characteristic	Performance Requirement
COMMAND ACCURACY (Cont)	
Waveform Functions (cont)	
Wfm Scaling Functions (cont)	
HSCL HSCL	Accurate to 4 significant digits $\pm(6 * 10^{-5}) * (\text{HSCL})$.
VZR VXPD	Accurate to 4 significant digits $\pm(6 * 10^{-4}) * (\text{VSCL})$.
Constant Functions	
Arithmetic Functions	
SQRT LN EXP +, -, /, *	Accurate to 4 significant digits.

POWER SOURCE

Voltage Range (AC, RMS)	Selected by rear-panel LINE VOLTAGE SELECTOR switch.
115 V Range	From 90 to 132 V.
230 V Range	From 180 to 250 V.
Line Frequency	From 48 to 440 Hz.
Maximum Power Consumption	230 W, nominal.
Maximum Current	3.5 A at 60 Hz, 90 V line. 1.8 A at 60 Hz, 180 V line.
Fuse	4 A fast-blowing type.

TABLE 2-3
Physical Characteristics

Characteristic	Information
Net Weight	
Mainframe (Without Plug-Ins)	19.0 Kg (42.0 lbs).
Waveform Calculator	1.14 Kg (2.5 lbs).
Overall Dimensions	
Mainframe	Refer to Figure 2-1.
Waveform Calculator	Refer to Figure 2-2.
Ventilation	Safe operating temperature maintained by electronically driven dc fan. Automated resetting, thermal cutout switch protects instrument from overheating.
Finish	Anodized front panel. Blue vinyl painted aluminum cabinet.

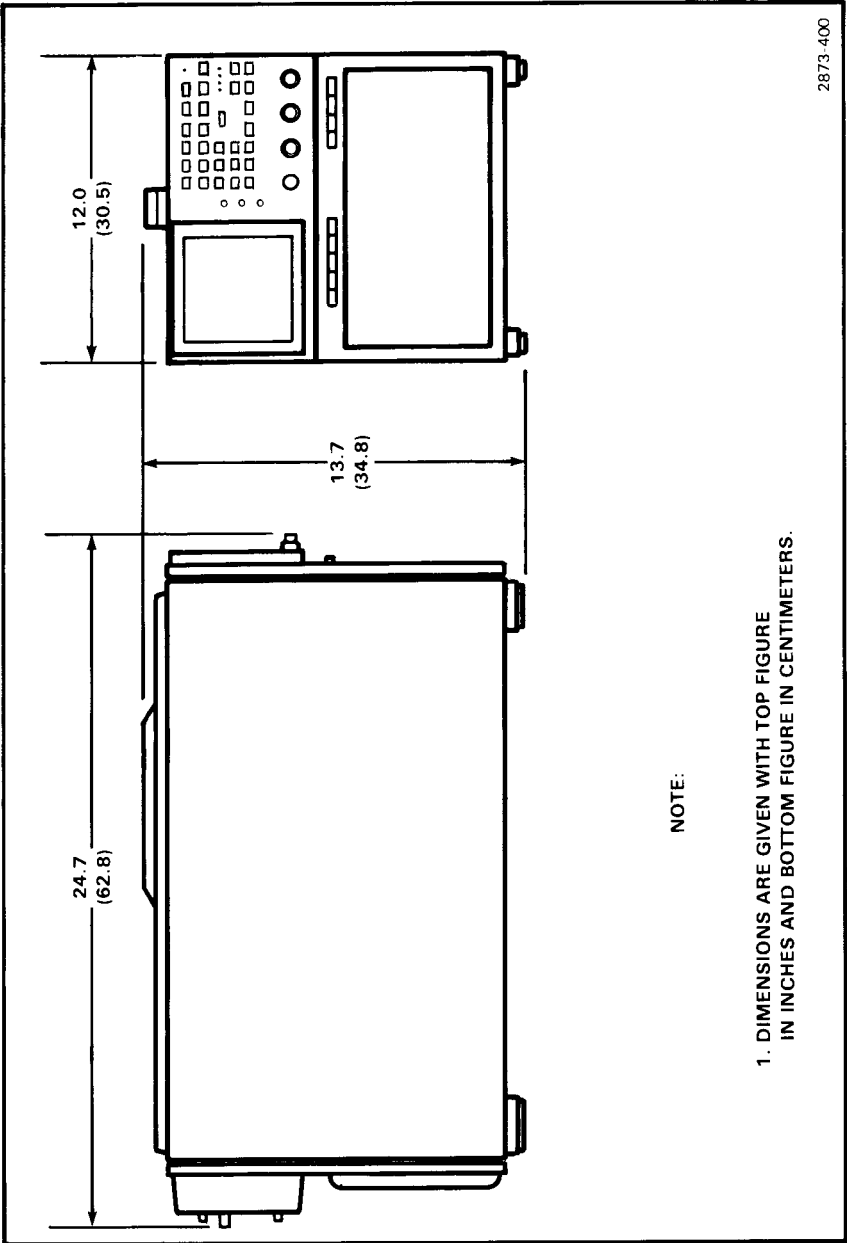

2873-400

NOTE:

1. DIMENSIONS ARE GIVEN WITH TOP FIGURE
IN INCHES AND BOTTOM FIGURE IN CENTIMETERS.

Figure 2-1. 7854 Mainframe dimensional drawing.

7000-SERIES OSCILLOSCOPE SYSTEMS SPECIFICATION

Your TEKTRONIX 7854 Oscilloscope system provides exceptional flexibility in operation with a wide choice of general- and special-purpose plug-in units. Usage of a plug-in unit can be determined by the type number as follows:

The first digit (7) denotes the oscilloscope system for which the plug-in is designed (7000-series).

The second letter describes the purpose of the plug-in unit:

- A — Amplifier unit
- B — "Real Time" time-base unit
- C — Curve tracer
- D — Digital unit
- L — Spectrum analyzer
- M — Miscellaneous
- S — Sampling unit
- T — Sampling time-base unit

The third and fourth digits of the plug-in type number do not carry any special connotation.

An "N" suffix letter added to the normal four-digit type number identifies a unit not equipped with the circuitry necessary to encode data for the 7000-series readout system; therefore, scale factor information cannot be acquired by the 7854 from these types of plug-in units.

Table 2-4 lists the horizontal specifications which are system dependent. For more complete specifications on plug-in units for the 7000-series oscilloscope system, refer to the Tektronix Products catalog.

Table 2-5 lists the vertical specifications which are system dependent. For more complete specifications on plug-in units for the 7000-series oscilloscope system, refer to the Tektronix Products catalog.

The 7854 Oscilloscope is compatible with Tektronix 7000-series plug-in units with the exceptions listed in Table 2-6.

TABLE 2-4
7854 Horizontal System Specifications

Time-Base Unit	Performance Feature	Maximum Calibrated Sweep Rate; Real-Time and Stored Data Paths ¹	Internal Triggering Frequency Range
7B10	Delayed Sweep	500 ps/div	Dc to 400 MHz
7B15	Delaying Sweep	500 ps/div	Dc to 400 MHz
7B70	Delayed Sweep and Ext Amplifier	2 ns/div	Dc to 200 MHz
7B71	Delaying Sweep	2 ns/div	Dc to 200 MHz
7B80	Delayed Sweep	1 ns/div	Dc to 400 MHz
7B85	Delaying Sweep	1 ns/div	Dc to 400 MHz
7B87	Pretrigger Acquire Clock	1 ns/div	Dc to 400 MHz
7B92A	Display Switching	500 ps/div	Dc to 400 MHz

¹Refer to Figure 1-1, in section 1, for definition of Data Path terms.

TABLE 2-5
7854 Vertical System Specifications

Amplifier Plug-In Unit	Real-Time and Stored Data Paths ³						VERT SIG OUT	
	Probe	Bandwidth (MHz)	Rise Time (ns)	Accuracy (%) ¹ 0° to +50° C		INT CAL	BW (MHz)	Tr (ns)
				EXT CAL	INT CAL			
7A11	Integral	200	1.8	2	3	135 MHz	2.6 ns	
7A12	None	105	3.4	2	3	105 MHz	3.4 ns	
	P6053B			3	4			
7A13	None	100	3.5	1.5	2.5	100 MHz	3.5 ns	
	P6053B							
	P6055							
7A14	P6021	65	5.4	2	3	65 MHz	5.4 ns	
	P6022	55	6.4			50 MHz	7.0 ns	
	None	110	3.2			100 MHz	3.5 ns	
7A15A/N	None	80	4.4	2	3	70 MHz	5.0 ns	
	P6053A			3	4			
7A16A	None	200 ²	1.8 ²	2	3	135 MHz	2.6 ns	
	P6053B			3	4			
7A17	None	150	2.4	—	—	15 MHz	24 ns	
7A18	None	75	4.7	2	3	70 MHz	5.0 ns	
	P6053B			3	4			
7A19	None	400 ²	0.9 ²	3	4	235 MHz	1.5 ns	
	P6056			3	4			
	P6057			4	5			
	P6201	375 ²	1.0 ²					

7A19(10 mV/Div Only)	None	325	1.1	3	4	235 MHz	1.5 ns
	P6056						
	P6057						
7A22	P6201	300	1.2	2	3	1.0 MHz ±10%	350 ns ±9%
	None or Any	1 MHz (within 10%)	350 (within 9%)				
	None	300 ²	1.2 ²				
7A24	P6056	—	—	3	4	135 MHz	2.6 ns
	P6057						
	P6201	275 ²	1.3 ²				
7A26	None	180 ²	1.9 ²	2	3	135 MHz	2.6 ns
	P6053B						
	None						
7A29	P6056	400 ²	0.9 ²	2	3	235 MHz	1.5 ns
	P6057						
	P6201						

¹Deflection Factor accuracy is checked as follows:

EXT CAL 0° to +50° C; Plug-in gain set at a temperature within 10° C of operating temperature, using an external calibrator with accuracy within 0.25%.

INT CAL 0° to +50° C; Plug-in gain set using the oscilloscope calibrator (within 10° C of the operating temperature) in a temperature range between 0° and +50° C.

²System temperature range from 0° to +35° C; derate 10% from +35° to +50° C.

³Refer to Figure 1-1, in section 1, for definition of Data Path terms.

TABLE 2-6
7854 Plug-In Incompatibilities

Plug-In Unit	Operating Conditions	Symptoms	Cause
VERTICAL AMPLIFIER UNITS			
7A21N	All operating conditions.	Unable to electrically and mechanically connect 7A21N to 7854.	<ol style="list-style-type: none"> 1. Delay-line output coaxial cable too short. 2. Delay-line output coaxial cable shorted together and connected to +5 volt supply on 7A21N board. 3. Harmonica connector for regulated supplies is wired differently on 7854. 4. Monitoring hole alignment is off.
7A18 7A18A 7A24 7A26	Plug-in chop.	7854 will not acquire any waveforms.	7854 logic does not allow AQR when plug-in unit is in chop mode.

HORIZONTAL AMPLIFIER UNITS

7B70 with 7B71	B starts after delay. B triggerable after delay.	Retrace when delayed sweep is delayed beyond end of delaying sweep.	Too much delay between 7B71 delay gate and 7B70 sweep gate.
7B50 7B51 7B52 7B53A	All operating conditions.	Leading edge of internally triggered waveform cannot be viewed.	7854 delay line length.

TABLE 2-6 (CONT)
7854 Plug-In Incompatibilities

Plug-In Unit	Operating Conditions	Symptoms	Cause
HORIZONTAL AMPLIFIER UNITS (Cont)			
7B50 7B51 7B70 7B71	7854 HORIZONTAL MODE in ALT with both horizontal time-base units set for single-sweep operation.	Only one time base will reset.	7854 alternate sweep switching logic locks out one time base; these time-base units do not reset when locked out.
7B10 7B15 7B80 7B85	Delayed sweep, Δ time mode, in 7854 B HORIZONTAL MODE.	Displayed traces mixed together.	The 7854 considers both waveforms to be one.
7B92 7B92A	Delayed sweep mode with both traces displayed.	Displayed traces mixed together.	Not a valid AQR mode, since the 7854 considers both waveforms to be one. The delaying sweep or the delayed sweep may be acquired as long as only one sweep is displayed.

SAMPLING UNITS

7T11 ¹	All operating conditions.	7T11 will not alternate with other sweep plug-in units.	7T11 does not generate holdoff pulses.
	Waveform acquisition with the 7854.	7854 will not finish an AQR. Unable to perform AVG or GND commands.	7T11 does not generate holdoff pulses.
7S12	7S12 set for single-scan operation.	7S12 will not start by remote or camera reset connectors.	7S12 does not provide single-sweep reset.

¹ The 7T11A does generate holdoff pulses and is therefore compatible.

TABLE 2-6 (CONT)
7854 Plug-In Incompatibilities

Plug-In Unit	Operating Conditions	Symptoms	Cause
SAMPLING UNITS (Cont)			
7S14	7S14 in dual trace, waveform AQR with the 7854.	7854 acquires both traces as one waveform.	7S14 sends no multiple waveform information to the 7854.
DIGITAL UNITS			
7D12	7D12 vertical display on.	7854 may indicate an AQR ERROR when the waveform is acquired.	7D12 alt/chop switch setting incorrect. Refer to 7D12 manual.
LOGIC ANALYZER UNITS			
7D01 7D02	Waveform acquisition (AQR) with the 7854.	Unable to acquire usable waveform or readout.	Multiple traces and incompatible readout format. (Use 7D01/7D02/7854 as conventional scope system only.)
SPECTRUM ANALYZER UNITS			
7L13	7L13 set for single-sweep operation.	7L13 will not start by remote or camera connector.	7L13 does not provide single-sweep reset.
7L5	7L5 set for non-storage mode with manual or normal sweep.	Single-sweep reset causes 7L5 to operate in single-sweep mode.	7L5 control logic.
	7854 waveform acquisition (AQR) in any 7L5 mode.	7854 will not acquire any 7L5 waveforms.	7L5 uses vertical plug-in chop which the 7854 will not acquire. (Custom modification available to resolve this problem.)

TABLE 2-6 (CONT)
7854 Plug-In Incompatibilities

Plug-In Units	Operating Conditions	Symptoms	Cause
SPECTRUM ANALYZER UNITS (Cont)			
7L18	7L18 stored waveform mode. 7854 waveform acquire (AQR) mode.	7854 acquires both traces as one waveform.	7L18 does not send multiple waveform data to the 7854. (Custom modification available to eliminate cursor trace.)
	7L18 set to non-store mode with manual or normal sweep.	Single-sweep reset causes 7L18 to operate in single-sweep mode.	7L18 logic.

SPECIAL PURPOSE

7CT1N	Waveform acquisition with the 7854.	7854 Acquires all curve tracer steps as one waveform.	7CT1N sends no multiple waveform information to the 7854.
-------	-------------------------------------	---	---

7854



General Operating Information

Information in this section of the manual applies in all operating modes of the 7854 Oscilloscope and includes information on:

1. The display graticule;
2. The light filter;
3. Care of the crt screen;
4. Control illumination;
5. Readout intensity;
6. Display focus and horizontal trace alignment;
7. The 7854 output signals; and
8. Display photography.

DISPLAY GRATICULE

The display graticule is marked on the inside of the crt faceplate to provide accurate, parallax-free visual display measurements. The display graticule is divided into eight vertical and ten horizontal divisions. The vertical gain and horizontal timing of the plug-in units are calibrated to the graticule markings so that accurate measurements can be made from the crt display. The illumination of the graticule lines can be varied with the GRAT ILLUM control. Figure 3-1 shows the display graticule and defines the various markings provided to aid visual measurements of the display. The terminology defined on the illustration will be used in all discussions involving the display graticule.

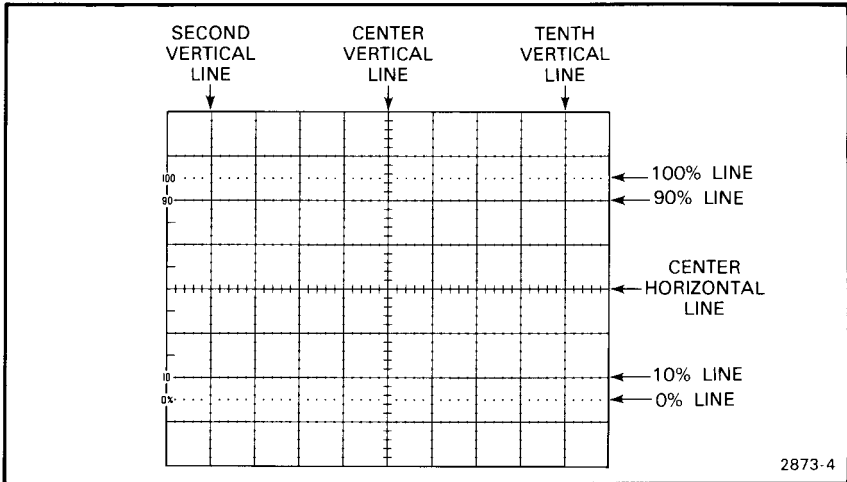

Figure 3-1. Definition of graticule markings.

LIGHT FILTER

The tinted crt faceplate filter minimizes light reflections from the face of the crt. This will improve the contrast when viewing the display under high ambient light. The light filter may be removed for crt photography. To remove the filter, pull outward on the bottom of the plastic crt mask and remove it from the crt bezel. Remove the tinted filter; leave the clear plastic implosion shield installed, and replace the mask. The implosion shield should be left in place at all times to protect the crt face from scratches.

WARNING

Do not remove the clear plastic implosion shield covering the crt faceplate; the crt implosion shield provides protection to the operator from crt implosion.

An optional mesh filter is available from Tektronix, Inc. (included with Option 3). This filter provides shielding against electromagnetic radiation from the face of the crt. The mesh filter fits in place of the plastic tinted filter and plastic crt mesh and also serves as a light filter. Order the mesh filter by Tektronix Part 378-0603-00.

CARE OF CRT SCREEN

To prolong the useful life of the crt phosphor, always use the minimum display intensity necessary to produce a clear, well-defined display and avoid repeated or prolonged use of the same area of the crt. If a particular display is to be observed for an extended period of time, change the position occasionally to use other portions of the display area.

CONTROL ILLUMINATION

The CONTROL ILLUMINATION switch, on the rear panel of the oscilloscope mainframe, sets the illumination level of the A and B TRIGGER SOURCE switches and of the lighted pushbutton switches on the plug-in units. The available positions are OFF, MEDIUM, and HIGH. The CONTROL ILLUMINATION switch does not affect the function or intensity indicators (such as BUSY, SRQ, and S), or the lights of the VERTICAL MODE and HORIZONTAL MODE selectors.

READOUT INTENSITY

The READOUT control determines the intensity of only the alphanumeric portion of the display, independently of the displayed waveforms. This control is functional in all display modes. The readout system is inoperative when the READOUT control is in the fully counterclockwise OFF position. This is desirable when the top and bottom divisions of the graticule are needed for waveform display, or when the real-time trace interruptions necessary to display the characters interfere with the displayed waveforms.

DISPLAY FOCUS

The 7854 Oscilloscope contains an automatic focusing circuit which maintains optimum focus for all intensity settings once a correct setting of the FOCUS control is established. The easiest way to obtain the correct setting of the FOCUS control is by focusing the characters of the readout display. First set the READOUT control so that the displayed characters are clearly visible, then adjust the FOCUS control for best definition of the character display.

ASTIGMATISM-FOCUS ADJUSTMENT

If a well-defined display cannot be obtained with the FOCUS control, use the following procedure to set the front-panel ASTIG adjustment.

NOTE

To check for proper setting of the ASTIG adjustment, slowly turn the FOCUS control through the optimum setting. If the ASTIG adjustment is correctly set, the vertical and horizontal portions of the display will focus at the same position of the FOCUS control. This setting of the ASTIG adjustment should be correct for any display.

1. Install an amplifier unit in the LEFT VERT compartment and a time-base unit in the A HORIZ compartment.
2. Set the 7854 Oscilloscope for SCOPE mode by pressing the **SCOPE** key on the measurement keyboard. Set the VERTICAL MODE switch to LEFT and the HORIZONTAL MODE switch to A, if necessary.
3. Connect the output of a sine-wave generator to the input of the amplifier unit. Set the sine-wave generator repetition rate to 1 kilohertz and the vertical amplifier deflection factor for a 2-division display.
4. Set the time-base unit sweep rate for 0.2 millisecond/division and the triggering for a stable display. Set the A INTENSITY control so the display is at a usable intensity level (about midrange).
5. Turn the FOCUS control fully counterclockwise and set the ASTIG adjustment to midrange.
6. Set the FOCUS control so the thickness of the sine wave is as thin as possible.
7. Adjust the ASTIG adjustment so the thickness of the sine wave is as thin as possible.
8. Repeat steps 6 and 7 for the best overall focus and consistent trace width.

HORIZONTAL TRACE ALIGNMENT

The TRACE ROTATION control allows the trace to be aligned with the horizontal graticule lines. To set the control, position the real-time trace (with no input signal applied to the selected amplifier plug-in unit) to the center horizontal line and adjust the TRACE ROTATION control so that the trace is parallel with the center horizontal graticule line.

CALIBRATOR OUTPUT

The CALIBRATOR provides a convenient signal for checking basic vertical gain and sweep timing, and is also useful for adjusting probe compensation as described in probe instruction manuals.

Accurate output voltages of 40 millivolts, 0.4 volt, and 4 volts into high-impedance loads are provided from the CALIBRATOR. In addition, 4 millivolts, 40 millivolts, and 0.4 volt are provided to drive 50-ohm loads. The current loop accessory (Tektronix Part 012-0341-00) provides a 40-milliampere output current (with CALIBRATOR set for 4-volt output), which can be used to check and calibrate current-measuring probe systems. The current signal is obtained by clipping the probe around the optional current loop accessory.

The repetition rate of the CALIBRATOR is 1 kilohertz. The calibrator circuit uses frequency-stable components to maintain accurate frequency and a constant duty factor. Thus the signal can also be used for checking the basic sweep timing of the time-base units (1-kilohertz rate only).

The square-wave output signal can be used as a reference wave shape when checking or adjusting the compensation of passive, high-resistance probes. The square wave from the CALIBRATOR has a flat top; therefore, any distortion in the displayed waveform is due to the probe compensation.

SIGNAL OUTPUTS

Three bnc connectors on the rear panel of the 7854 Oscilloscope mainframe provide output signals for the user.

+ SAWTOOTH OUT

The + SAWTOOTH OUT connector provides a positive-going sawtooth signal from either the time-base unit installed in the A HORIZ or from the time-base unit installed in the B HORIZ compartment, regardless of the display mode selected.

WARNING

To avoid electric-shock hazards, only qualified service personnel should internally modify the operation of this instrument.

Selection of either the A HORIZ or B HORIZ compartment as the source of the + SAWTOOTH OUT signal is possible. Refer such selection to qualified service personnel only. The unit of time for the sawtooth output is determined by the setting of the time/division switch of the appropriate time-base unit. Refer to Table 2-1, in the Specification section, for specific signal parameters.

+ GATE OUT

WARNING

To avoid electric-shock hazards, only qualified service personnel should internally modify the operation of this instrument.

The + GATE OUT connector provides a positive-going rectangular pulse which is derived from a time-base unit installed in either horizontal compartment, regardless of the display mode selected. The + GATE OUT signal can be selected from either the A HORIZ compartment or the B HORIZ compartment. Refer such selection to qualified service personnel only. The duration of the + GATE OUT signal is the same as the duration of the respective sweep, or in the case of the delayed gate, will start at the end of the delay period and last until the end of the sweep from the delaying time-base unit. The amplitude of the + GATE OUT signal is about 0.5 volt into a 50-ohm load, or about 10 volts into a 1-megohm load.

SIGNAL OUT

The SIGNAL OUT connector provides a sample of the real-time vertical deflection signal from the LEFT VERT or RIGHT VERT amplifier plug-in unit, regardless of the display mode selected. The source of the signal at this connector is determined by the A TRIGGER SOURCE switch. With the A TRIGGER SOURCE switch in the VERT MODE position, the output signal is determined by the setting of the VERTICAL MODE switch. If the VERTICAL MODE is in LEFT or RIGHT, the output signal is obtained only from the trigger source of the selected vertical unit. In the ALT vertical mode, the SIGNAL OUT switches between the trigger signals from the two vertical units. However, due to the requirements of the triggering system, the output signal in the CHOP vertical mode is a composite signal (the algebraic sum of the trigger signals) as is obtained in the ADD vertical mode. The LEFT VERT and RIGHT VERT positions of the A TRIGGER SOURCE switch are independent of the vertical mode selected, and therefore provide the vertical trigger output signal only from the selected vertical unit (even though the vertical unit may not be selected for display).

The amplitude of the SIGNAL OUT into a 50-ohm load is about 25 millivolts/division of crt display, or about 0.5 volt/division of crt display into a 1-megohm load. See Table 2-1 in the Specification section of this manual.

DISPLAY PHOTOGRAPHY

A permanent record of the crt display can be obtained with an oscilloscope camera system. The instruction manual for the Tektronix Oscilloscope Camera includes complete instructions for obtaining waveform photographs.

The crt bezel provides integral mounting for Tektronix Oscilloscope Cameras. The three pins located on the left side of the crt bezel connect power to compatible camera systems. Control signals are also received from Tektronix automatic cameras to allow camera-controlled single-shot photography (see the camera manual for further information).

If the alphanumeric portion of the display is to be included on waveform photographs, the following suggestions will aid in obtaining good photographs:

1. Focus the oscilloscope display and the camera on the alphanumeric portion of the crt display. The auto-focus feature in this instrument will help to maintain the traces at optimum focus.
2. Set the READOUT control for the minimum intensity setting that allows the alphanumeric characters to be written. This normally occurs at a slightly lower intensity level than is necessary for complete writing of the waveform display. Some experimentation may be necessary to establish the correct level. Too high a setting of the READOUT control will result in a broad, poorly defined photograph of the alphanumeric display.

7854

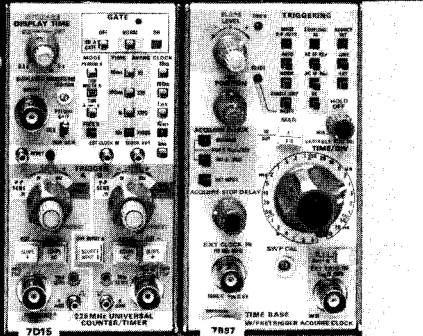
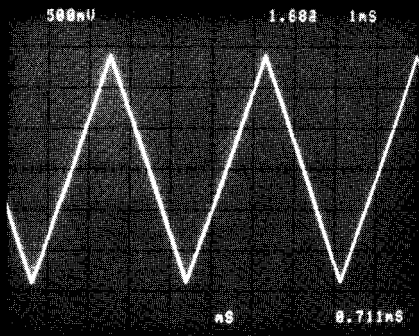
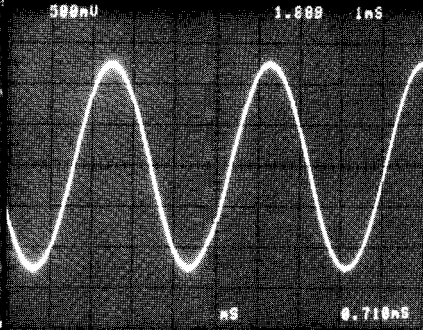
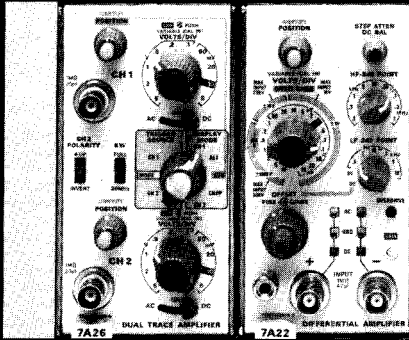

Scope Display Mode Information

In the SCOPE display mode only the real-time waveforms and readout are displayed on the crt screen. The capabilities of the 7854 Oscilloscope in this mode depend mainly upon the plug-in units selected for use with the mainframe. All 7A-series vertical amplifier plug-in units can be used with the 7854 Oscilloscope. Bandwidth and sensitivity ranges should be taken into consideration when selecting amplifier units. Time-base units of the 7B10-, 7B80-, and 7B90-series are also compatible with the 7854 Oscilloscope. Sweep rates and triggering ranges should be considered when selecting time-base plug-in units. In addition, several special purpose plug-in units are available to allow the 7854 to be used for many specialized applications. See the Tektronix Products catalog for further information. Specific applications for the 7854 are not given in this manual. Contact your Tektronix Field Office or representative for assistance in making specific measurements.

All keys on the 7854 keyboards are active in the SCOPE display mode; however, the results of pressing a key will not be apparent.

Information given in this section of the manual applies only to real-time waveform and readout displays and includes:

1. Obtaining a scope display;
2. The real-time A and B INTENSITY controls;
3. Z-Axis modulation;
4. Using the BEAMFINDER;
5. The real-time readout display;
6. The vertical and horizontal mode combinations;
7. Vertical trace separation;
8. Intensity contrast;
9. Trigger source selection; and
10. The real-time functions checkout procedure.

OBTAINING A SCOPE DISPLAY

To obtain a SCOPE (real-time) display, first connect the 7854 Oscilloscope mainframe (POWER switch off) to a power source that meets the voltage requirements of the instrument. If the available line voltage is outside the setting limits of the LINE VOLTAGE SELECTOR switch (on the rear panel), set the LINE VOLTAGE SELECTOR to the appropriate setting.

NOTE

This exercise will be referred to from other sections of this manual as you learn the greater capabilities of the 7854 Oscilloscope. Flagging this page may be useful.

1. Set the front-panel controls as follows:

GRAT ILLUM	Counterclockwise
READOUT	Quarter range
STORED INTensity	Counterclockwise
A INTENSITY	Counterclockwise
FOCUS	Midrange
B INTENSITY	Counterclockwise
POWER	Off
CALIBRATOR	4 V
VERTICAL MODE	LEFT*
A TRIGGER SOURCE	VERT MODE
HORIZONTAL MODE	B*
VERT TRACE SEPARATION (B)	Midrange
B TRIGGER SOURCE	VERT MODE
GPIB ADDRESS SELECTOR	OFF line

*These controls are automatically set to the specified positions as a power-up condition. See Power-Up Conditions in Section 1, Introduction.

2. Install Tektronix 7A-series amplifier units in the LEFT VERT and RIGHT VERT compartments, and Tektronix 7B-series time-base units in the A HORIZ and B HORIZ compartments.
3. Press the POWER switch to the on (locked in) position. Notice that the oscilloscope will go through the automatic verification sequence described in section 1 under Power-Up Conditions.
4. Set both time-base units to 0.5 millisecond/division and triggering to auto mode with ac coupling from the internal source.

5. Rotate the B INTENSITY control until the trace is at a desirable viewing level (about quarter range).
6. Connect the CALIBRATOR output to the channel 1 input of the LEFT VERT amplifier unit with a 42-inch bnc cable.
7. Set the deflection factor of the LEFT VERT amplifier unit to display a signal amplitude of 2 divisions on the crt.
8. Set the B HORIZ time-base triggering controls for a stable display, triggered on the negative-going slope.

The 1-kHz, 4-volt CALIBRATOR signal is now displayed on the crt screen.

A AND B INTENSITY CONTROLS

The A INTENSITY control determines the brightness of the display produced by the plug-in unit installed in the A HORIZ compartment; the B INTENSITY control determines the brightness of the display produced by the plug-in unit installed in the B HORIZ compartment.



CAUTION

To avoid damage to the crt phosphor, avoid any condition where an extremely bright, sharply-focused dot exists on the crt screen. Also, remember that the light filter reduces the apparent light output from the crt.

The crt display brightness (beam current) is limited during X-Y operation or when either, or both, time-base units being displayed are set for a slow sweep rate. This reduces the danger of damaging the crt phosphor with a stationary or slowly moving spot.

Z-AXIS MODULATION

Z-axis modulation can be used to relate a third item of electrical phenomena to the vertical (Y-axis) and the horizontal (X-axis) coordinates without affecting the waveshape of the real-time signal. This is accomplished by changing the intensity of the real-time waveform to provide a "gray scale" display.

The voltage amplitude required for visible trace modulation depends on the setting of the A and B INTENSITY controls. A two-volt, peak-to-peak, signal applied to the Z-AXIS INPUT connector will completely blank the display even at maximum intensity levels; lower amplitude signals can be used to change only the relative trace brightness. Negative-going signals increase the display intensity and positive-going signals decrease the display intensity.

Refer to Table 2-1, in the Specification section of this manual, for Z-axis signal requirements.

Time markers applied to the Z-AXIS INPUT connector provide a direct time reference on the display. With uncalibrated horizontal sweep, the time markers provide a means of reading time directly from the display. If the markers are not time-related to the displayed waveform, use a single-sweep display.

The Z-axis blanking phenomena or the real-time X-Y display cannot be stored in waveform memory.

USING THE BEAMFINDER

The BEAMFINDER pushbutton helps locate a real-time display that overscans the crt viewing area either vertically or horizontally. When the BEAMFINDER is pressed, the display is compressed and defocused to be within the graticule area.

To locate and reposition an overscanned real-time display:

1. Press the BEAMFINDER. While the display is compressed, change the vertical and horizontal deflection factors of the vertical amplifier and horizontal time-base plug-in units until the display is about two divisions high and four divisions wide. (Horizontal deflection usually needs to be reduced only in X-Y modes.)
2. Adjust the vertical and horizontal position controls to center the display on the graticule.
3. Release the BEAMFINDER; the display should remain within the graticule area.

REAL-TIME READOUT DISPLAY

The readout system provides an alphanumeric display of information on the crt along with the waveform display. When the 7854 is in the SCOPE display mode, the alphanumeric information displayed by the readout system is obtained from the plug-in units installed in the plug-in compartments.

The readout information from each channel or each plug-in unit is called a "word". Up to eight words of real-time readout information may be displayed on the crt (two channels from each of the four plug-in compartments). The location of each readout word is fixed and is directly related to the plug-in unit and channel from which it originates. Figure 4-1 shows the area of the graticule where the readout word from each plug-in unit channel is displayed. Notice that the readout from channel 1 of each plug-in unit is displayed in the top division of the graticule, and the readout from channel 2 is displayed directly below that of channel 1 in the bottom division of the graticule. Only the readout information for plug-in units and channels selected will usually appear in the crt viewing area. However, some special purpose plug-in units may over-ride the VERTICAL MODE and HORIZONTAL MODE switches (in the SCOPE display mode) to display readout even though the compartment is not selected for display.

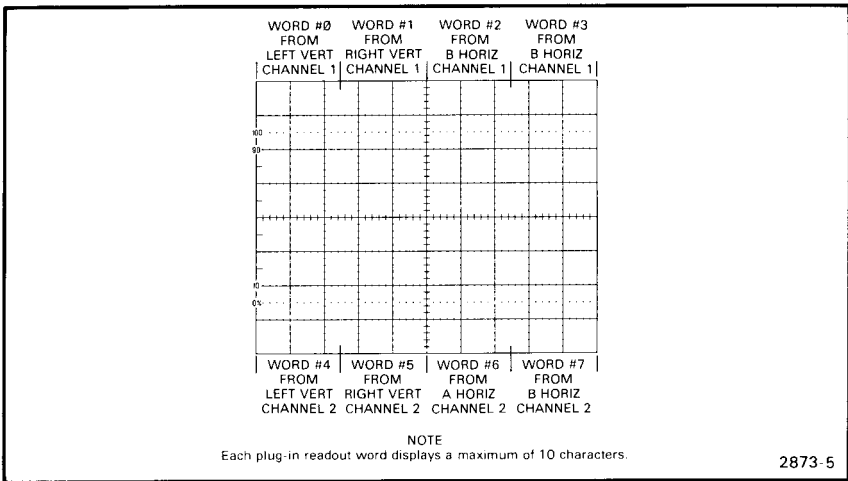

Figure 4-1. Location and definition of the real-time readout.

READOUT IDENTIFY

An "Identify" feature is provided on some probes and amplifier units to correlate the real-time readout word with the originating plug-in unit and channel. When the "Identify" button of an amplifier unit or probe is pressed, the word **IDENTIFY** appears in the readout location allocated to that plug-in and channel. Other readout words in the display remain unchanged. When the "Identify" button is released, the readout display from the plug-in channel is again displayed. Circuitry in some amplifier units can also produce a noticeable change in the real-time waveform display to identify the associated trace when the "Identify" button is pressed (see the plug-in unit instruction manual for details).

READOUT ACCESS PLUG-IN UNIT

The 7M13 READOUT plug-in unit provides convenient control of the crt readout characters. This allows information, such as dates and identifying nomenclature, to be displayed on the crt in the SCOPE display mode. This capability is particularly useful when making photographs.

VERTICAL AND HORIZONTAL MODE COMBINATIONS

Twenty combinations of VERTICAL MODE and HORIZONTAL MODE switch settings are possible. The total possible number of real-time display combinations is further multiplied by the variety of plug-in units available for use with this instrument, the interchangeability of plug-ins (i.e., either an amplifier or a time-base unit can be installed in any of the four compartments), and by the capabilities of the plug-in units which are used in the instrument (e.g., a dual-trace amplifier unit can be used in either of the two single-channel modes, in dual-trace modes, or added-algebraically mode; a delaying time base may be used either for a sweep or for a delayed sweep). Since listing all display combinations which can occur in the SCOPE display mode would be difficult due to the large selection of available plug-in units, Table 4-1 lists only the displays obtained with each combination of VERTICAL MODE and HORIZONTAL MODE switch positions. Status of the VERTICAL and HORIZONTAL MODE switches is indicated by the illuminated buttons. These switches do not latch.

VERTICAL MODES

When the LEFT or RIGHT button of the VERTICAL MODE switch is pressed, only the signal from the plug-in unit in the designated compartment is displayed.

Alternate Mode

The ALT position of the VERTICAL MODE switch produces a display which alternates between the LEFT VERT and RIGHT VERT compartments with each sweep. Although the ALT mode can be used at all sweep rates, the CHOP mode provides a more satisfactory display at sweep rates below about 20 milliseconds/division. At these slower sweep rates, the alternate-mode switching becomes perceptible.

Alternate mode displays have three types of triggering available. When the A and B TRIGGER SOURCE switches are set to the VERT MODE position, each sweep is triggered by the signal being displayed on the crt. This provides a stable display of two unrelated signals, but does not indicate the time relationship between the signals. In the LEFT VERT or RIGHT VERT positions of the TRIGGER SOURCE switches, the two signals are displayed showing true time relationships. However, if the signals are not time related, the display from the plug-in unit not providing a trigger signal will be unstable on the crt.

TABLE 4-1
Real-Time Display Combinations¹

Vertical Mode	Horizontal Mode	Comments
LEFT	A or B	One trace. Vertical deflection from single unit; horizontal deflection from single unit.
	ALT or CHOP	Two traces. Vertical deflection from single unit; horizontal deflection from both units.
ALT	A or B	Two traces. Vertical deflection from both units; horizontal deflection from single unit.
	ALT or CHOP	Two traces. Vertical deflection from both units; horizontal deflection from both units. Independent-pairs (sweep slaving) operation. See Alternate Mode discussion in this section.
ADD	A or B	One trace. Vertical deflection is algebraic summation of signals from both units; horizontal deflection from single unit.
	ALT or CHOP	Two traces. Vertical deflection is algebraic summation of signals from both units; horizontal deflection from both units.
CHOP	A or B	Two traces. Vertical deflection from both units; horizontal deflection from single unit.
	ALT or CHOP	Four traces. Vertical deflection from both units; horizontal deflection from both units.
RIGHT	A or B	One trace. Vertical deflection from single unit; horizontal deflection from single unit.
	ALT or CHOP	Two traces. Vertical deflection from single unit; horizontal deflection from both units.

¹Combinations given are for single-channel vertical and horizontal units only.

When the ALT vertical mode is selected and either the ALT or CHOP horizontal mode is selected, the instrument operates in the independent-pairs (sweep-slaving) mode. During this mode, the signal from the LEFT VERT unit is always displayed at the sweep rate of the B HORIZ time-base unit, and the signal from the RIGHT VERT unit is displayed at the sweep rate of the A HORIZ time-base unit (non-delayed sweep only). This results in two displays which are completely independent of each other in vertical deflection and sweep rate. This independent-pairs display is equivalent to the display obtainable with a dual-beam oscilloscope for most repetitive display combinations.

The display sequence in independent-pairs mode of operation is somewhat changed in delayed-sweep operation of the time-base unit. First, the LEFT VERT signal is displayed at the sweep rate of the A HORIZ time-base unit (delaying sweep), then at the rate of the B HORIZ time-base unit (delayed sweep). The vertical display then shifts to display the RIGHT VERT signal consecutively at the delaying and delayed sweep rates.

Chopped Mode

The CHOP position of the VERTICAL MODE switch produces a display which is electronically switched between the LEFT VERT and RIGHT VERT signals, at about a one-megahertz rate. In general, the CHOP mode provides the best display at sweep rates slower than about 20 milliseconds/division or whenever dual-trace, real-time, single-shot phenomena are to be displayed. At faster sweep rates the chopped switching becomes apparent and may interfere with the display.

When the A or B TRIGGER SOURCE switches are set to VERT MODE, the internal trigger signals from the vertical plug-ins are algebraically added, and the time-base units are triggered from the resultant signal. The LEFT VERT or RIGHT VERT trigger-source positions provide trigger signals to the time-base units from the selected vertical unit only. This allows two time-related signals to be displayed showing true real-time relationships. (If the signals are not time-related, the display from the channel which is not providing the trigger signal will appear unstable.)

The CHOP mode can be used to compare two single-shot, transient, or random real-time signals which occur within the time interval determined by the time-base unit (ten times the selected sweep rate). To provide correct triggering, the displayed signal providing the trigger signal must precede the second display.

Algebraic Addition

The ADD position of the VERTICAL MODE switch can be used (1) to display the sum or difference of two real-time signals, (2) for common-mode rejection to remove an undesired signal, or (3) for dc offset (applying a dc voltage to one channel to offset the dc component of a signal on the other channel).

The overall deflection on the crt in the ADD mode is the algebraic sum of the real-time signals from the two vertical plug-in units. Determining the voltage amplitude of the resultant display is difficult unless the amplitude of the signal applied to one of the plug-ins is known. This is particularly true when the vertical units are set to differing deflection factors, since it is not obvious which portion of the display results from the signal applied to a given plug-in unit. The polarity and repetition rate of the applied signals will also affect the ADD display.

Observe the following precautions when using the ADD mode:

1. Do not exceed the input-voltage ratings of the plug-in units.
2. Do not apply large signals to the plug-in units. A good rule is to limit the applied signal to no more than about eight times the vertical deflection factor. For example, with a vertical deflection factor of 0.5 volt/division, the voltage applied to that plug-in should not exceed four volts. Larger voltages may result in a distorted display.
3. To ensure the greatest dynamic range in the ADD mode, set the position controls of the plug-in units to a setting which would result in a mid-screen display if viewed in the LEFT or RIGHT positions of the VERTICAL MODE switch.
4. For similar response from each channel, use identical plug-ins and set the plug-in units for the same type of input or coupling mode.

HORIZONTAL MODES

When either the A or B button of the HORIZONTAL MODE switch is pressed, the vertical signal is displayed at the sweep rate of the selected time-base unit. Set the applicable intensity control and trigger-source switch for the desired display.

Alternate Mode

The ALT position of the HORIZONTAL MODE switch provides crt sweeps derived alternately from the two time-base units. Although the ALT horizontal mode can be used at all sweep rates, the CHOP mode provides a more satisfactory display at sweep rates below about 20 milliseconds/division. At slower sweep rates, the switching between the traces becomes perceptible.

NOTE

This instrument will not present a real-time display in the ALT position of the HORIZONTAL MODE switch if either horizontal plug-in compartment is left vacant.

The A and B INTENSITY controls allow individual adjustment of the traces produced by the time-base units in the A HORIZ and B HORIZ compartments. Correct triggering of both time-base units is essential in obtaining the correct display in the ALT horizontal mode. If either of the time-base units does not receive a correct trigger, and therefore does not produce a sweep, the other unit cannot produce a sweep either. This means that one time-base unit cannot begin its sweep until the previous unit has completed its entire display. This can be avoided by setting the time-base units for auto-mode triggering. See Trigger Source for operation of the A and B TRIGGER SOURCE switches. Also, see Vertical Trace Separation for information about positioning the B HORIZ display when in the ALT horizontal mode.

Chopped Mode

When the CHOP button of the HORIZONTAL MODE switch is pressed, the real-time display is electronically switched between the two time-base units at about a 200-kilohertz rate. In general, the CHOP horizontal mode provides the best display (1) when either of the time-base units is set to a sweep rate slower than about 20 milliseconds/division, and (2) when the two time-base units are set to widely differing sweep rates. In the CHOP horizontal mode, equal time segments are displayed from each of the time-base units. This provides a real-time display which does not greatly change in intensity as the sweep rate of either time-base unit is reduced (in contrast to the ALT horizontal mode where the slowest trace tends to be the brightest).

The A and B INTENSITY controls provide individual intensity adjustment of the traces produced by the time-base units in the A HORIZ and B HORIZ compartments. Triggering is not as critical in the CHOP horizontal mode as in ALT; if one of the units is not properly triggered, only the trace from the untriggered time-base unit is missing from the display. The other trace is presented in the normal manner. See Vertical Trace Separation and Trigger Source for further information.

VERTICAL TRACE SEPARATION

When either of the dual-sweep horizontal modes (ALT or CHOP) is selected, the VERT TRACE SEPARATION (B) control allows the trace produced by the B HORIZ plug-in to be positioned above or below the trace produced by the A HORIZ plug-in. To use the control, first position the trace produced by the A HORIZ unit. Then, adjust the VERT TRACE SEPARATION (B) control to move the trace produced by the B HORIZ unit away from the A HORIZ display.

INTENSITY CONTRAST

The CONTRAST adjustment varies the brightness of the intensified portion of the real-time waveform displayed when the A HORIZ and B HORIZ time-base units are operating in the delaying/delayed mode. (This adjustment does not affect the cursors displayed in the STORED display mode.)

TRIGGER SOURCE

The A and B TRIGGER SOURCE switches select the internal trigger signals for the A HORIZ and B HORIZ time-base units. For most applications, these switches can be set in the VERT MODE position. In this position, the internal trigger signal is automatically switched as the VERTICAL MODE switch is changed, or as the display is electronically switched between the LEFT VERT and RIGHT VERT plug-ins while

in the ALT vertical mode. The VERT MODE position also provides a usable trigger signal in the ADD or CHOP positions of the VERTICAL MODE switch. Therefore, this trigger source position ensures that the time-base units receive a trigger signal regardless of the setting of the VERTICAL MODE switch.

If correct triggering for the desired display cannot be obtained in the VERT MODE position, the trigger source for either time-base unit can be changed to obtain the trigger signal from either the LEFT VERT or RIGHT VERT plug-in. The internal trigger signal is obtained from the selected vertical compartment whether the plug-in in that compartment is selected for display or not. If the internal trigger is selected from a vertical unit which is not also selected for display, the trigger signal must be time-related to the displayed signal in order to obtain a triggered (stable) display.

REAL-TIME FUNCTIONS CHECKOUT PROCEDURES

This checkout procedure verifies proper operation of the real-time related controls, indicators, and connectors; and may also be used to familiarize the operator with the operation of the mainframe controls, indicators, and connectors. The processor-related functions, such as those selected with the measurement and Waveform Calculator keyboards, can be verified by performing the exercises given in sections 5 and 6.

Only functions (not measurement quantities or specifications) are checked in this procedure; therefore, a minimum amount of test equipment is required. If performing this checkout procedure reveals improper performance or instrument malfunction, check the operation of associated equipment; then refer to qualified service personnel for repair or adjustment of the instrument.

TEST EQUIPMENT REQUIRED

The following test equipment was used in this checkout procedure. Other test equipment which meets these requirements may be substituted. When other equipment is substituted, the control settings or setup may need to be altered.

1. Function Generator (used only to check out the Z-AXIS INPUT)

Description: Frequency range, 250 kilohertz to 1 megahertz; output amplitude, 2 volts peak-to-peak into 50 ohms; waveshape, sine.

Type Used: TEKTRONIX SG 503 Signal Generator (used with TM 500 Power Module).

2. Cables (2 required)

Description: Length, 42 inches; connectors, bnc.

Type Used: Type RG-58/U, 50-ohm coaxial, Tektronix Part 012-0057-01.

3. T Connector

Description: Connectors, bnc-to-bnc.

Type Used: Bnc-to-bnc connector, Tektronix Part 103-0030-00.

4. Adapter

Description: Connectors, bnc female-to-bnc female.

Type Used: Bnc female-to-bnc female, Tektronix Part 103-0028-00.

PRELIMINARY SETUP

1. Connect the 7854 to a power source that meets the voltage requirements of this instrument (POWER switch off). If the available line voltage is outside the setting limits of the LINE VOLTAGE SELECTOR switch (on rear panel), see Operating Power Information under Installation in section 1.

2. Set the front-panel controls as follows:

FOCUS	Midrange
B INTENSITY	Counterclockwise
A INTENSITY	Counterclockwise
READOUT	OFF
STORED INTENSITY	Quarter range
GRAT ILLUM	Counterclockwise
POWER	ON
CALIBRATOR	4 V
VERTICAL MODE	LEFT*
A TRIGGER SOURCE	VERT MODE
HORIZONTAL MODE	A*
VERT TRACE SEPARATION (B)	Midrange
B TRIGGER SOURCE	VERT MODE
CRT DISPLAY	SCOPE

*LEFT and B are automatically selected as Power-Up Conditions. (See Section 1, Introduction.)

3. Install Tektronix 7A-series amplifier units in the LEFT VERT and RIGHT VERT compartments. Install Tektronix 7B80-, 7B90-, or 7B10-series time-base units in the A HORIZ and B HORIZ compartments.
4. Set both time-base units to 1 millisecond/division and triggering to auto mode with ac coupling from the internal source.
5. Rotate the A INTENSITY control until the trace is at a desirable viewing level. (Position trace if necessary.)
6. Connect the CALIBRATOR output to the input of the LEFT VERT amplifier unit with a 42-inch bnc cable.
7. Set the LEFT VERT deflection factor to display a signal amplitude of 2 divisions on the crt.
8. Set the A HORIZ time-base triggering for a stable display.

DISPLAY FOCUS CHECKOUT

Rotate the FOCUS and ASTIG controls and observe the square-wave display. Notice that the thickness of the trace varies. Set the FOCUS and ASTIG controls for a well-defined trace as described in steps 6 through 8 of the Astigmatism-Focus Adjustment procedure in section 3.

TRACE ALIGNMENT CHECKOUT

Disconnect the input signal. Position the LEFT VERT trace to the center horizontal graticule line. If necessary, use the TRACE ROTATION control to align the trace with the center graticule line.

GRATICULE ILLUMINATION CHECKOUT

Rotate the GRAT ILLUM control throughout its range and notice that the graticule lines are illuminated as the control is turned clockwise.

CONTROL ILLUMINATION AND TRACE INTENSITY CHECKOUT

Set the rear-panel CONTROL ILLUMINATION switch to HIGH. Notice that the A INTENSITY indicator and the selected pushbutton switch positions are all illuminated. Sequentially press all of the HORIZONTAL MODE switch positions and notice the A and B INTENSITY lights; these lights indicate which intensity control is active. Set the CONTROL ILLUMINATION switch to the MEDIUM position. Observe

dimming of the lighted pushbutton switches on the plug-in units and the selected settings of the TRIGGER SOURCE switches.

Rotate the active A or B INTENSITY control and notice that the corresponding trace intensity varies. Press **STORED** on the measurement keyboard and notice that the STORED INTensity indicator is lit. Rotate the STORED INTensity control and notice that the stored trace intensity varies.

Set the rear-panel CONTROL ILLUMINATION switch to the HIGH position. Press **SCOPE** and return the HORIZONTAL MODE switch to A.

VERTICAL DEFLECTION CHECKOUT

Connect the 4-V CALIBRATOR output to the input connectors of both amplifier units with two 42-inch bnc cables and a bnc T connector. Set the deflection factor of the LEFT VERT amplifier unit to display about 2 divisions of signal on the crt.

Notice that the position control of only the LEFT VERT amplifier unit affects the vertical position of the displayed square wave. Position the square wave to the upper half of the graticule.

Set the VERTICAL MODE switch to RIGHT. Set the deflection factor of the RIGHT VERT amplifier unit to display about 2 divisions of signal on the crt.

Notice that the position control of only the RIGHT VERT amplifier unit affects the vertical position of the displayed square wave. Position the square wave to the lower half of the graticule.

Set the VERTICAL MODE switch to ALT. Two traces should be displayed on the crt. The top trace is produced by the LEFT VERT amplifier unit and the bottom trace is produced by the RIGHT VERT amplifier unit; the sweep for both traces is produced by the A HORIZ time-base unit. Set the sweep rate of the A HORIZ time-base unit to 50 milliseconds/division; notice the display alternates between the LEFT VERT and RIGHT VERT amplifier units after each sweep. Turn the A HORIZ time-base sweep rate switch through its range; notice that the display alternates between amplifier units at all sweep rates.

Set the VERTICAL MODE switch to CHOP. Turn the A HORIZ time-base unit sweep rate switch throughout its range. A dual-trace display will be presented at all sweep rates, and both amplifier units are displayed by the A HORIZ time-base unit on a time-sharing basis. Set the A HORIZ time-base unit sweep rate switch to 0.5 millisecond/division.

Set the VERTICAL MODE switch to ADD. The display should be four divisions in amplitude. Notice that the position control of either amplifier unit moves the display. Set the VERTICAL MODE switch to LEFT.

HORIZONTAL DEFLECTION CHECKOUT

Position the start of the trace to the left-most graticule line with the A HORIZ time-base position control. Notice that the position control of only the A HORIZ time-base unit affects the horizontal position of the displayed trace (not the position control of the B HORIZ time-base unit).

Set the HORIZONTAL MODE switch to B. Adjust the B INTENSITY control for a visible display.

Notice that the position control of only the B HORIZ time-base unit affects the horizontal position of the displayed trace. Position the start of the trace to the left-most graticule line with the B HORIZ time-base unit position control.

Set the HORIZONTAL MODE switch to ALT. Two traces should be presented on the crt. If the traces overlap, set the VERT TRACE SEPARATION (B) control to position one trace to the bottom of the graticule area. Turn the sweep rate switches of both time-base units throughout their range. Observe that each time-base unit controls one of the traces independently of the other time-base unit. Also notice that when one of the time-base units is set to a slow sweep rate (below about 50 milliseconds/division) sweep alternation is evident (only 1 of the traces is presented on the crt at a time). Set the sweep rates of both time-base units to 0.5 milliseconds/division. Rotate the A INTENSITY control; notice that the intensity of the trace produced by the A HORIZ time-base unit changes. Likewise, the B INTENSITY control changes the intensity of the trace produced by the B HORIZ time-base unit only. Return both INTENSITY controls to desirable levels.

Set the HORIZONTAL MODE switch to CHOP. Two traces should be displayed on the crt in a manner similar to that of the ALT display. Turn the sweep rate switches of both time-base units throughout their ranges.

Set the CALIBRATOR switch to 0.4 V. Set the VERTICAL MODE switch to CHOP. Four traces should be displayed on the crt. If not, set the position controls of the amplifier units and the VERT TRACE SEPARATION (B) control to position the four traces into view. Set the position controls of the plug-in units to identify which trace is produced from each plug-in unit. (If amplifier units have the "Identify" feature, it can be used to identify the traces.) Set the A HORIZ time-base unit for a sweep rate of 1 millisecond/division. The LEFT VERT amplifier unit should be displayed at the sweep rate of both time-base units.

Set the HORIZONTAL MODE switch to ALT. Observe that the display is very similar to that obtained in the previous sweep. The main difference in this display is that the traces are now displayed alternately (noticeable only at slow sweep rates).

Set the VERTICAL MODE switch to ALT. Set the CALIBRATOR switch to 4 V. Notice that only 2 traces are displayed. The trace produced by the LEFT VERT amplifier unit should be displayed at the sweep rate of the B HORIZ time-base unit and the trace produced by the RIGHT VERT amplifier unit should be displayed at the A HORIZ

time-base unit sweep rate. This feature is called independent-pairs operation and is obtained only when the VERTICAL MODE switch is in the ALT position, the HORIZONTAL MODE switch is in either the ALT or the CHOP position, and the time-base units are in the independent mode.

TRIGGERING CHECKOUT

Set the VERTICAL MODE switch to LEFT and the HORIZONTAL MODE switch to A. Center the display on the crt with the LEFT VERT amplifier position control. Disconnect the input signal from the RIGHT VERT amplifier unit input connector. Sequentially select all of the VERTICAL MODE switch positions. Notice that a stable display is obtained in all settings of the VERTICAL MODE switch (straight line in RIGHT switch position).

Set the A TRIGGER SOURCE switch to LEFT VERT. Again, sequentially select all of the VERTICAL MODE switch positions; notice that the display is again stable in all positions, as in the previous step, and that the LEFT VERT pushbutton is illuminated.

Set the A TRIGGER SOURCE switch to RIGHT VERT. Sequentially select all of the VERTICAL MODE switch positions and notice that a stable display cannot be obtained in any position (this is because there is no input signal connected to the RIGHT VERT amplifier unit) and that the RIGHT VERT pushbutton is illuminated. Return the A TRIGGER SOURCE switch to VERT MODE and notice that it is illuminated.

The B TRIGGER SOURCE switch operates in a manner similar to the A TRIGGER SOURCE switch when the B HORIZ time-base unit is selected to provide the display. Set the B TRIGGER SOURCE switch to VERT MODE and the VERTICAL MODE switch to ALT.

Set the HORIZONTAL MODE switch to B and the VERTICAL MODE switch to LEFT.

READOUT CHECKOUT

Turn the READOUT control clockwise until an alphanumeric display is visible within the top or bottom division of the crt. Change the deflection factor of the amplifier unit that is selected for display. The readout should change as the deflection factor is changed. Likewise, change the sweep rate of the time-base unit which is selected for display; the readout for the time-base unit should change as the sweep rate is changed.

Set the selected time-base unit for X10 magnification. Notice that the readout display will change to indicate the correct magnified sweep rate. If a readout-encoded 10X probe is available for use with the amplifier unit, install it on the input connector of the LEFT VERT amplifier plug-in unit. Notice that the deflection factor indicated by the readout is increased 10 times when the probe is added. Return the time-base unit to normal sweep operation and disconnect the probe.

Sequentially select all of the VERTICAL MODE and HORIZONTAL MODE switch positions. Notice that the readout from a particular plug-in occupies a specific location on the display area. If either of the vertical plug-in units is a dual-trace unit, the readout for channel 2 is displayed within the lower division of the crt. Return the VERTICAL MODE switch to LEFT and the HORIZONTAL MODE switch to A. Set the READOUT control to OFF.

BEAMFINDER CHECKOUT

Set the deflection factor of the LEFT VERT amplifier to 10 millivolts/division and the CALIBRATOR for a 4 V output. Notice that the square-wave display is not visible, since the deflection exceeds the scan area of the crt.

Press the BEAMFINDER push-button switch; notice that the display is returned to the viewing area in compressed form. Release the BEAMFINDER switch and notice that the display again disappears from the viewing area.

With the BEAMFINDER switch pushed in, increase the LEFT VERT amplifier deflection factor until the display is reduced to about 2 divisions vertically. Adjust the position control of the displayed amplifier unit to position the compressed display near the center of the graticule. Release the BEAMFINDER switch and observe that the display remains within the viewing area.

CALIBRATOR CHECKOUT

Connect the CALIBRATOR output to both the LEFT VERT and RIGHT VERT amplifier units with two bnc cables and a bnc T connector. The display amplitude should be approximately 2 divisions. If not, adjust the deflection factor accordingly.

Select different CALIBRATOR pushbuttons (labeled 4 V, 0.4 V, and 40 mV) and notice that the displayed signal changes accordingly (CALIBRATOR output must be terminated into more than a 100 kilohm load for stated output). When the CALIBRATOR output is terminated into 50 ohms, the output is 0.1 times the stated output.

Z-AXIS INPUT CHECKOUT

If an external signal is available (2 volts peak-to-peak minimum), the function of the Z-AXIS INPUT can be demonstrated. Connect the external signal to both the input connector of the displayed amplifier unit and the Z-AXIS INPUT connector. Set the sweep rate of the displayed time-base unit to display about 5 cycles of signal. Set the amplitude of the signal generator until intensity modulation is visible on the display (change the amplifier unit deflection factor as necessary to produce an on-

screen display). The positive peaks of the waveform should be blanked out and the negative peaks intensified. Notice that the setting of the INTENSITY controls determines the amount of intensity modulation that is visible. Disconnect the cables.

SIGNAL OUT CHECKOUT

Set the VERTICAL MODE switch to CHOP and connect the SIGNAL OUT connector to the input of the RIGHT VERT amplifier unit. Connect the 4 V CALIBRATOR output to the LEFT VERT amplifier unit. Notice that the CALIBRATOR output waveform is present at the SIGNAL OUT connector at reduced amplitude.

+ SAWTOOTH OUT CHECKOUT

Set the VERTICAL MODE switch to RIGHT and connect the + SAWTOOTH OUT connector to the input of the RIGHT VERT amplifier unit. Set the HORIZONTAL MODE switch to A. Notice that a sawtooth waveform is displayed. Remove the B HORIZ time-base unit and notice the display. If the sawtooth waveform disappears, the + sweep sawtooth signal available at the + SAWTOOTH OUT connector originates from the B HORIZ time-base unit as selected by the Sweep Selector switch. If the sawtooth display remains, the + sweep sawtooth available at the + SAWTOOTH OUT connector originates from the A HORIZ time-base unit as selected by the Sweep Selector switch.

+ GATE OUT CHECKOUT

The signal available at the + GATE OUT connector is dependent on the Gate Selector switch position (i.e., A, B, or Delay'd). If the Gate Selector switch setting is not known, the following procedure will determine the switch setting and verify that the proper signal is present.

Set the VERTICAL MODE switch to RIGHT and connect the + GATE OUT connector to the input of the RIGHT VERT amplifier unit. Set the HORIZONTAL MODE switch to A. If a single square-wave + gate display is obtained proceed to the next paragraph; if not, the Gate Selector switch is set to Delay'd and, thus, the signal available at the + GATE OUT connector is the delayed gate from the A HORIZ time-base unit, which requires that a delaying time-base unit be installed in the A HORIZ compartment. Set the A HORIZ delaying time-base unit for B Starts After Delay mode. Notice that the display is a single square wave. Vary the delaying time base delay-time control and notice that the displayed square-wave width varies.

Remove the B HORIZ time-base unit and notice the display. If the + gate waveform disappears, the + gate signal available at the + GATE OUT connector originates from the B HORIZ time-base unit as selected by the Gate Selector switch. If the + gate display remains, the + gate signal available at the + GATE OUT connector originates from the A HORIZ time-base unit as selected by the Gate Selector switch.

SINGLE SWEEP RESET CHECKOUT

Connect the 4 V CALIBRATOR output to the LEFT VERT amplifier unit. Obtain a display of the CALIBRATOR output. Set both time-base unit triggering controls for single-sweep operation. Connect one end of the bnc cable to the rear panel + GATE OUT connector. Connect the other end of the cable to the SINGLE SWEEP RESET connector while watching the crt. A single-sweep display of the CALIBRATOR output signal should be obtained each time the + GATE OUT signal is applied to the SINGLE SWEEP RESET connector.

This completes the Real-Time Functions Checkout Procedures.

7854

Tektronix 7854 OSCILLOSCOPE

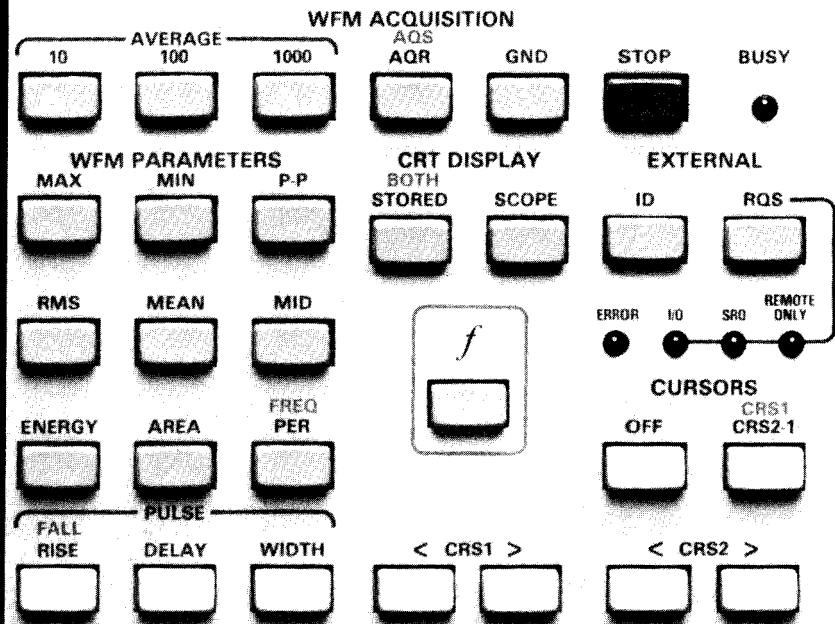

Using the Measurement Keyboard

This section of the manual demonstrates, in the form of self-teaching exercises, the operation of all front-panel measurement keyboard commands, except those given in the EXTERNAL block. These exercises are for the Option 0D 7854 Oscilloscope which can be operationally simulated by disconnecting the Waveform Calculator and the GPIB cables from the oscilloscope rear-panel connectors.

All displays shown in the exercises in this manual are correct for the given conditions—specified and previously displayed real-time waveform, the position of the stored waveform, etc.—but might not be exactly duplicated on your instrument due to the extreme sensitivity of the processor. Therefore, your readings may vary slightly from those shown in the exercise displays.

In addition to the exercises to demonstrate the WFM ACQUISITION, CURSOR, and WFM PARAMETER commands available on the measurement keyboard, this section includes information on:

1. Waveform storage considerations;
2. The command buffer;
3. Error and warning indications; and
4. The character display in the STORED and BOTH modes.

WAVEFORM STORAGE CONSIDERATIONS

Before measurements can be made by the processor, the real-time waveform must be stored in waveform memory. With Option ØD, only one waveform can be stored at a time. Scale factors (vertical deflection factor and horizontal sweep rate) with units, and the vertical zero reference (VZR) are stored in memory with the waveform points since all are required to fully specify the waveform value.

The processor can only store the waveform selected by the VERTICAL MODE, HORIZONTAL MODE, or plug-in unit display mode switches; other waveforms, or those which would be displayed with a plug-in unit chop mode, are considered invalid by the processor and cannot be stored. Each acquisition command has an associated maximum number of waveforms which can be displayed during execution; if more are selected, the processor cannot perform the acquisition command and an error condition exists. (See Error and Warning Indications later in this section for more details.)

Only one repetitive real-time waveform can be selected for display prior to any AVG (Average) command; however, two waveforms can be selected at the time of an AQR (Acquire Repetitive Waveform) or **AQS** (Acquire Single-Sweep Waveform) command. If two waveforms are selected at the time of an AQR or **AQS** command, only one will be stored and available for subsequent measurement. Use the following rules to determine which selected waveform is stored:

1. If the two waveforms are selected with the VERTICAL MODE switch in ALT or CHOP, the vertical values of the stored waveform are those from the LEFT VERT plug-in unit.
2. If the two waveforms are selected with the plug-in unit in the alternate mode, the vertical values of the stored waveform are those from channel 1 of the plug-in unit.
3. If the VERTICAL MODE switch is in ADD and either vertical plug-in unit is in the alternate mode, the vertical values of the stored waveform are those of channel 1 of the alternating plug-in added to the value of the other plug-in unit.
4. If the two waveforms are displayed with the HORIZONTAL MODE switch in ALT or CHOP, the sweep values of the stored waveform are those from the B HORIZ time-base unit.

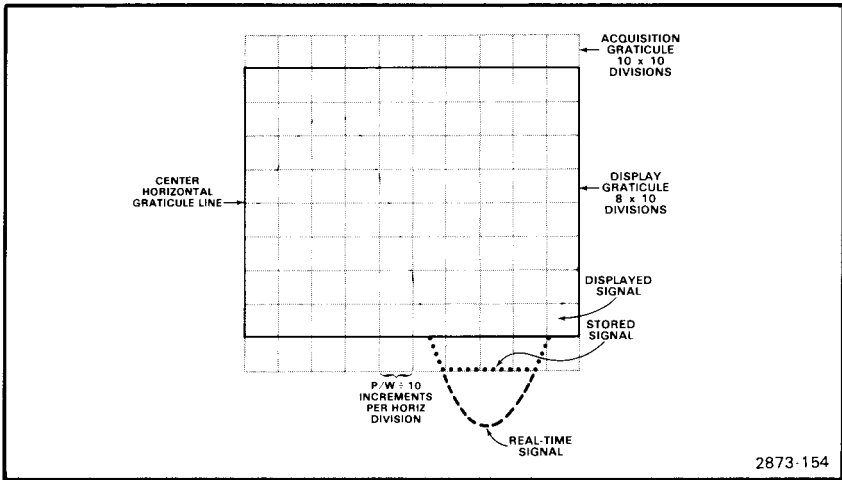

Figure 5-1. The acquisition graticule in relation to the display graticule.

The stored waveform consists of the vertical coordinate values of 512 equally-spaced horizontal points taken from within the boundaries of a 10×10 division "acquisition graticule" (see Fig. 5-1). Any part of the real-time signal which exceeds the vertical limits of + or - 5 divisions from vertical zero (the center horizontal graticule line) is clipped at the edge of the acquisition graticule. Any points outside the 10 -division horizontal limits are ignored.

If the selected VERTICAL MODE, HORIZONTAL MODE, and plug-in display mode settings would result in more than one vertical or horizontal scale factor readout being displayed in the SCOPE display mode, the processor performs a search sequence to determine which one will be stored with the waveform points. The first valid scale factor encountered in the search is stored. The vertical scale factor search sequence is: LEFT VERT channel 1 (R0), LEFT VERT channel 2 (R4), RIGHT VERT channel 1 (R1), and RIGHT VERT channel 2 (R5). The horizontal scale factor search sequence is: B HORIZ (R3, R7), A HORIZ (R2, R6). (See Fig. 4-1 for locations of the readout, R designated, word.)

If a valid scale factor is not found in the required readout word(s), a default scale factor of "1" is assigned by the processor and a warning is issued. To determine if the required readout word is a valid scale factor, the processor scans the readout word starting at the first (leftmost) character. If the readout word is blank, or contains non-numeric characters only, the default scale factor is assigned. Leading non-numeric characters, such as ">", are not stored as part of the scale factor. The scale factor unit (e.g., V or S) is stored and displayed with the scale factor, but is not used by the processor for any other purpose.

COMMAND BUFFER

Keyboard commands (except STOP) received while the processor is BUSY are stored in the command buffer (capacity: 10 commands) while awaiting execution. (A STOP command is executed immediately and any remaining commands in the buffer are discarded). If commands are received while the command buffer is full, they are ignored and a warning is issued. Normally the processor will continue executing the commands in the order they were received until the buffer is empty. However, if an error occurs, processing stops and the command buffer is immediately emptied of any stored commands.

ERROR AND WARNING INDICATIONS

Before executing any command the processor checks for error conditions which would prevent execution; and during command execution the processor checks for warning conditions which could give incorrect or unexpected results. Whenever an error or warning condition occurs, an audible warning lasting approximately 300 milliseconds is issued (if the rear-panel AUDIBLE ERROR/WARNING switch is ON). During this tone, in either the STORED or BOTH display modes, the alphanumeric and stored waveform display are blanked to provide additional warning. (In SCOPE display mode, only the readout portion of the display is blanked during the tone.) The ERROR indicator will light for either an error or a warning, and will remain lit until another command is received by the processor.

NOTE

If an error or warning occurs during the SCOPE display mode when the AUDIBLE ERROR/WARNING switch is OFF, the condition might not be noticed. Therefore, always pay close attention to the ERROR indicator whenever any command is issued.

ERRORS

When an error condition occurs, execution of the command is aborted and any subsequent commands stored in the command buffer are erased. The ERROR indicator is lit and the error message is displayed until the condition is corrected or until a new command is given. Error messages are displayed in the STORED and BOTH display modes only and in the form: _____, where _____ are the first three mnemonic characters of the aborted command. Table 9-20 lists the error conditions which can occur.

WARNINGS

If during command execution a condition occurs which may cause the results to be other than might normally be expected for the command, execution is completed and (in STORED or BOTH display modes) a warning message is displayed until a new command is given. Warning messages are displayed in the form: _____, where _____ are the first three characters of the command mnemonic associated with the warning. Table 9-21 lists warning conditions which can occur.

WAVEFORM ACQUISITION EXERCISES

A real-time waveform is placed in memory using either the AQR, AQS, AVG10, AVG100, or AVG1000 commands. These command keys are located in the WFM ACQUISITION block at the top of the 7854 measurement keyboard (see Fig. B, block 6). Also located in this block are the GND (Ground) and STOP keys, and the BUSY indicator. The STOP key prematurely terminates a GND, AQR, AVG10, AVG100, or AVG1000 command if that command is still executing. The BUSY indicator lights when the processor is busy executing any command.

NOTE

The GND and PAUSE commands (not labeled on panel) are available as the shift functions of the GND and STOP keys respectively. However, as they are of little use to the operator without the Waveform Calculator or GPIB interface, they are discussed in Section 6, Using the Waveform Calculator.

The following exercises only illustrate the function and operation of the WFM ACQUISITION keys and indicator, and must be sequentially performed in order to obtain similar results.

ACQUIRING A REPETITIVE WAVEFORM

Perform the procedure for Obtaining a Scope Display given in Section 4, Scope Display Mode Information.

Position the 4 V CALIBRATOR signal so that the first positive-going pulse starts at the second vertical graticule line, and so the square wave is centered around the center horizontal graticule line.

Set the STORED INTensity control to quarter range.

To Acquire the waveform:

Press

AQR

Display

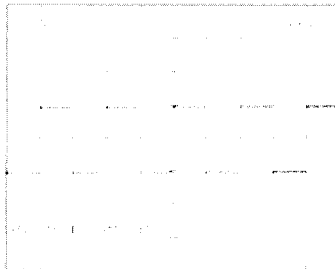

Comments

The BUSY indicator is lit while the processor is executing the command. Scale factors (vertical deflection factor and horizontal sweep rate) of the valid waveform are acquired and stored. AQR WARNING is issued (and displayed in the STORED or BOTH modes) if: (1) More than 5% contiguous points are not filled, (2) an invalid

ACQUIRING A REPETITIVE WAVEFORM (Cont)

Comments (cont)

scale factor readout is encountered, (3) non-unique scale factors are encountered in add vertical modes, or (4) the AQR command is prematurely terminated with the STOP command. Refer to Waveform Storage Considerations for further details.

NOTE

If the specified readout position does not contain a valid scale factor, a default value of "1" is assigned by the processor and an AQR WARNING is displayed when in the STORED or BOTH display modes.

AQR Operation: Equivalent-time random sampling is used to construct the waveform into memory from as many repetitions of the real-time waveform as required (see Fig. 5-2). This command is useful at all sweep speeds.

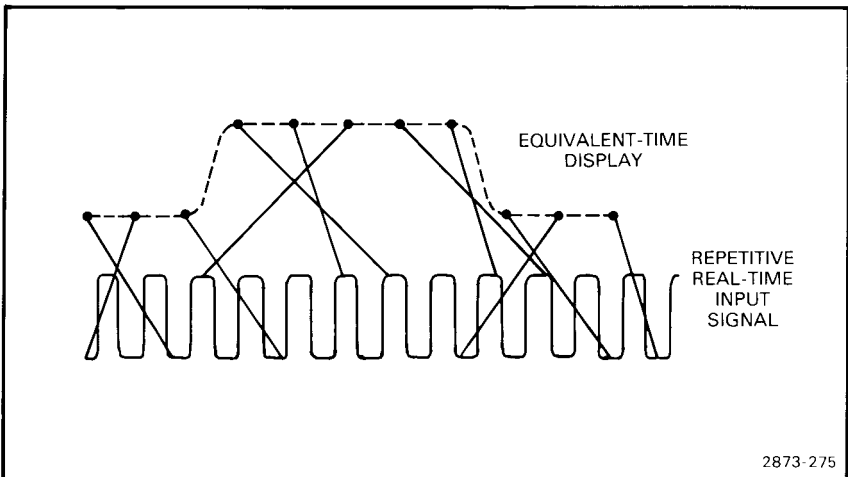

Figure 5-2. The input pulse of a repetitive signal is reconstructed using equivalent-time random sampling.

ACQUIRING A REPETITIVE WAVEFORM (Cont)

The digitizer simultaneously samples and quantizes the repetitive real-time waveform. This sampling is asynchronous with respect to the sweep and only the samples acquired within the horizontal limits of the graticule while the waveform is visible are considered valid. During digitizing most of the waveform points will have been sampled more than once, while some may not have been filled at all. The most recent data is retained in memory.

Waveform acquisition is terminated when at least 99% of all valid points have been sampled and stored into memory and at least one complete sweep has occurred, or when a STOP command is received.

AQR Restrictions: No more than two real-time waveforms may be selected for display and no plug-in chop modes are permitted prior to execution of an AQR command. **ERROR** is issued if either restriction is violated.

Press

STORED

Display

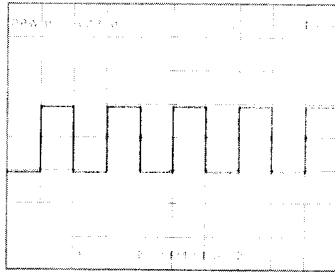

Comments

The stored calibrator signal with scale factors and data from the processor is displayed on the crt.

NOTE

Notice that the stored calibrator signal is a representation, both in waveshape and position, of the real-time CALIBRATOR signal just observed in the SCOPE display mode; however, the alphanumeric information has changed. The alphanumeric displayed in the STORED display mode are discussed in detail under Stored Character Display following these exercises.

SETTING THE GROUND REFERENCE (IN THE BOTH MODE)

Notice that the number following (vertical zero reference) in line #1 of the stored display has been to this point in the exercises. This means that the 0-volt level of the stored waveform is assumed to be at the center horizontal graticule line. This setting is a Power-Up Condition (see section 1) set by the processor. The GND command provides a means to set a specific ground reference level for subsequently stored waveforms.

To demonstrate, go to the BOTH display mode:

Press



Display

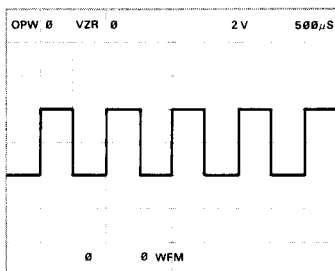

Comments

The processor is flagged to perform the shift function of the next key pressed. (If the next key pressed does not have a shift function, no function is performed.)

BOTH

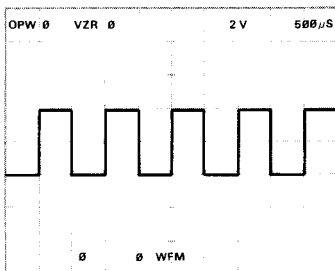

Both the real-time and the stored calibrator signals are displayed. Rotate the LEFT VERT amplifier position control to verify that both waveforms are present. (See Both Display Mode for further information.)

Exercise continues on next page

SETTING THE GROUND REFERENCE (Cont)

Now set the input coupling switch of the LEFT VERT amplifier unit to ground, and position the trace to one division below the center horizontal graticule line. This will be the new ground reference level.

Press

GND

Display

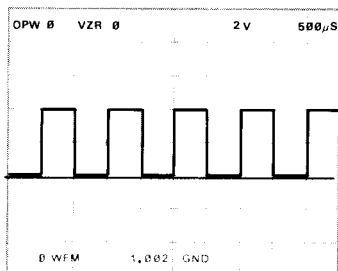

Comments

Although the displayed waveforms do not change, the BUSY indicator lights and BUSY is displayed while the processor stores this level in a ground reference register. The vertical value, 1.002 in this example, is given in graticule divisions with reference to the center horizontal graticule line; and is displayed in the X register location—bottom line, center, of the crt. This new ground reference will not change until either a new GND command is issued or the 7854 is turned off.

Set the input coupling switch of the LEFT VERT amplifier unit to dc. Do not reposition the real-time waveform.

Press

AQR

Display

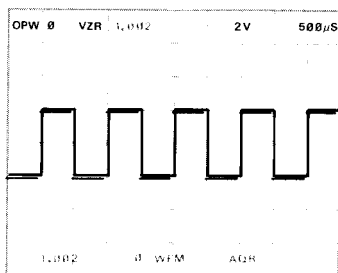

Comments

The previously stored waveform has been replaced by the newly acquired calibrator signal.

SETTING THE GROUND REFERENCE (Cont)

Press

STORED

Display

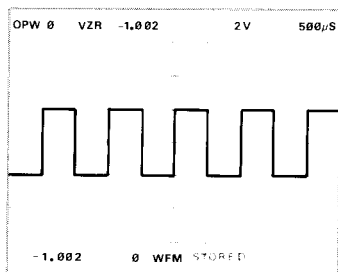

Comments

The stored calibrator signal is displayed with the baseline at the new ground reference level. VZR reading in the top division of the graticule reflects the currently stored ground setting of -1.002 division below the center horizontal graticule line.

GND Operation: The processor stores the algebraic mean vertical level of the real-time trace for the ground (vertical zero) reference of waveforms subsequently stored.

GND Restrictions: No more than two real-time waveforms may be selected for display and no plug-in chop modes are permitted prior to execution of the GND command. GND ERROR is issued if either restriction is violated.

*To assure that the ground reference is set as close as possible to the desired level, monitor the ground setting as displayed in the X register of the STORED or BOTH modes. If the value displayed is not what you want, simply reposition the real-time trace and press **GND** again. Repeat if necessary.*

AVERAGING A WAVEFORM

To remove random noise which may be present on the real-time waveform or to increase the resolution of the digitized waveform, use an AVG (Average) command. The **AVG10**, **AVG100**, and **AVG1000** keys on the measurement keyboard averages the real-time waveform the specified number of times before placing the resulting waveform into waveform memory.

To demonstrate, return to the SCOPE display mode by pressing **SCOPE**. Next, set the VERTICAL MODE to ADD and attach an unshielded cable to the 1 MΩ input of the RIGHT VERT amplifier unit. Set the RIGHT VERT amplifier to maximum sensitivity and the LEFT VERT amplifier to 1 V/Div. Set the B HORIZ time base for 0.2 milliseconds/division. The crt should display a 4-division square wave with about 1 division of noise riding on it. Return to the STORED display mode by pressing **STORED**.

Press

AVG100

Display

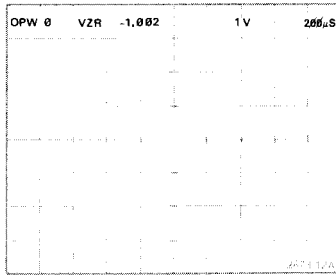

Comments

During command execution: the BUSY indicator is lit; the previously stored waveform is maintained on the display; and the mnemonic, message, and number of averages to be completed are displayed in the bottom division (line #16) of the graticule.

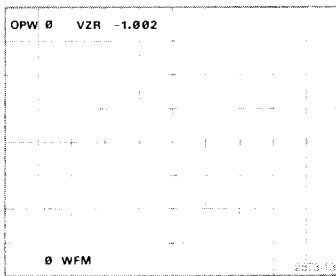

After command execution: the BUSY indicator is off; the newly stored waveform is displayed in line #16 of the display; and the last command mnemonic, message, and number of averages to be completed are displayed.

AVERAGING A WAVEFORM (Cont)

AVG Operation: Acquires repetitive real-time waveform as for AQR command. Then the processor repeatedly re-acquires the real-time waveform, by points, and accumulates new data into the corresponding points of the stored waveform. If the value of a point is found to be changed from its initial value, the difference is modified with a weighting factor and added to the initial value. The result is that at any time during averaging the stored waveform will approximate the algebraic mean value of the individual waveforms acquired so far.

AVG Restrictions: Only one real-time waveform may be selected for display, no chop or alternate modes permitted, prior to execution of the AVG commands. is issued if this restriction is violated.

STOPPING ACQUISITION

The STOP command is used to terminate either an AQR, GND, or AVG command while the processor is busy executing that command. To illustrate:

Press

AVG1000

Comments

The display is similar to that previously described during execution of AVG100.

While the BUSY indicator is lit:

Press

STOP

Display

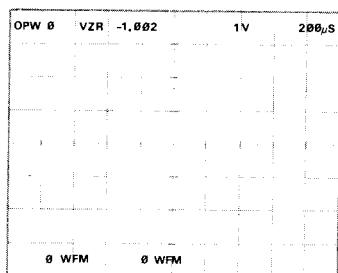

Comments

The stored waveform now consists of the number of averages completed prior to the STOP; if no averages were completed, all waveform points are set to zero. is issued when a STOP is executed.

NOTE

The STOP command is executed immediately upon receipt by the processor.

NEXT EXERCISE BEGINS WITH POWER-UP

ACQUIRING A SINGLE-SWEEP WAVEFORM

When the real-time signal to be stored is not repetitive because of varying amplitude, waveshape, or repetition rate, use the **AQS** command to store the signal.

To acquire a single-sweep waveform, perform the first step of Obtaining a Scope Display given in Section 4, Scope Display Mode Information.

Then install a Tektronix 7A-series amplifier unit in the LEFT VERT compartment and a 7B87 Time Base With Pretrigger Acquire Clock in the B HORIZ compartment.

Perform steps 3 through 8 of the procedure for Obtaining a Scope Display.

Now set the 7B87 to the single-sweep mode. (Refer to the 7B87 Instruction Manual for more detailed operating information for the 7B87 Time Base With Pretrigger Acquire Clock.)

Press

STORED

Display

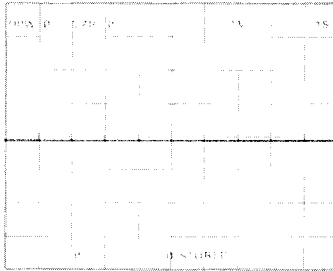

Comments

Stored display at power-up.

f **AQS**

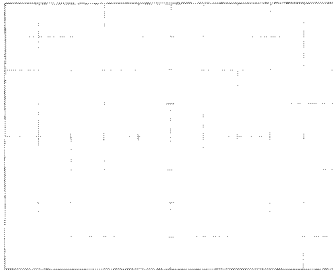

The display is blanked and the BUSY indicator is lit while the processor awaits the triggered sweep.

ACQUIRING A SINGLE-SWEEP WAVEFORM (Cont)

Press

7B87 Single
Sweep Reset
Pushbutton

Display

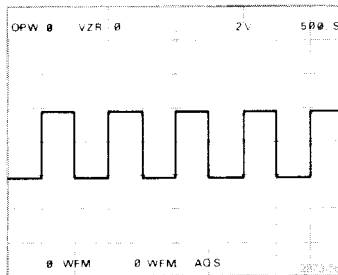

Comments

Stored single-sweep calibrator signal and AQS mnemonic are displayed. AQS WARNING is issued if more than 5% contiguous points are not filled.

AQS Operation: The processor uses real-time sampling (see Fig. 5-3) to sequentially sample and store 512 points of the single-sweep waveform unless the command is prematurely terminated by use of the rear-panel AQS ABORT pushbutton. The processor will not accept any other commands during AQS execution (which includes waiting for the single-sweep trigger).

If fewer than 512 points have been stored when the command is terminated, the stored points are right-justified on the display and the remaining points are displayed at the value of the first stored point. If no points have been sampled when the command is terminated, all points are set to and displayed at the vertical zero reference level.

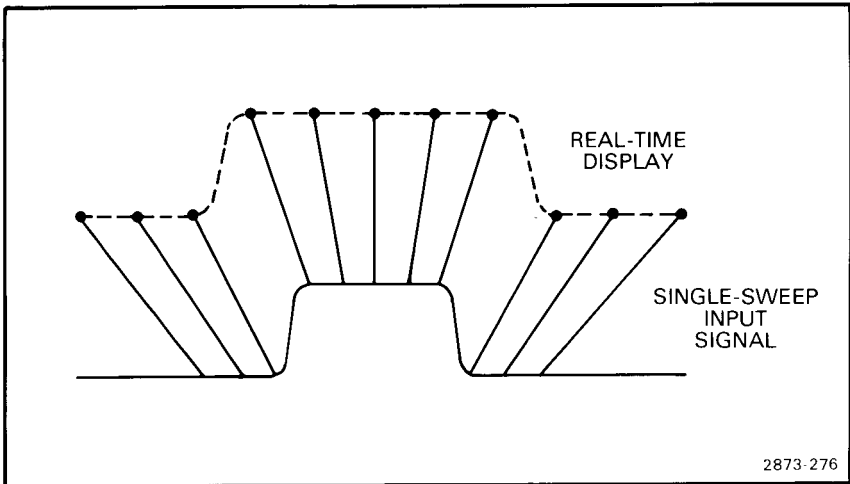

Figure 5-3. The single-sweep input signal is sequentially sampled and each point is displayed as it actually occurred.

ACQUIRING A SINGLE-SWEEP WAVEFORM (Cont)

NOTE

This command can be prematurely terminated only with the rear-panel AQS ABORT pushbutton.

AQS Restrictions: No more than two real-time waveforms may be selected for display and no plug-in chop display modes are permitted prior to execution of the AQS command. Also the B HORIZ compartment must contain a properly adjusted 7B87 Time Base with Pretrigger Acquire Clock that is selected for display. AQS ERROR is issued if either restriction is violated.

NEXT EXERCISE BEGINS WITH POWER-UP

STORED CHARACTER DISPLAY

With the 7854 in the STORED or BOTH display modes, the alphanumeric character information displayed by the crt is provided by the processor. In addition to the stored waveform scale factors, data and status messages from the processor are also displayed. Each data message or scale factor is displayed in a specific fixed field (see glossary) assigned to that item. The graticule area is formatted into 16 display lines (numbered 1 through 16, top to bottom) of 40 characters each. Each field is assigned a maximum number of characters, and is not necessarily unique with respect to data assigned. A typical character display in the STORED mode is shown in Figure 5-4. Refer to this illustration throughout the following discussion.

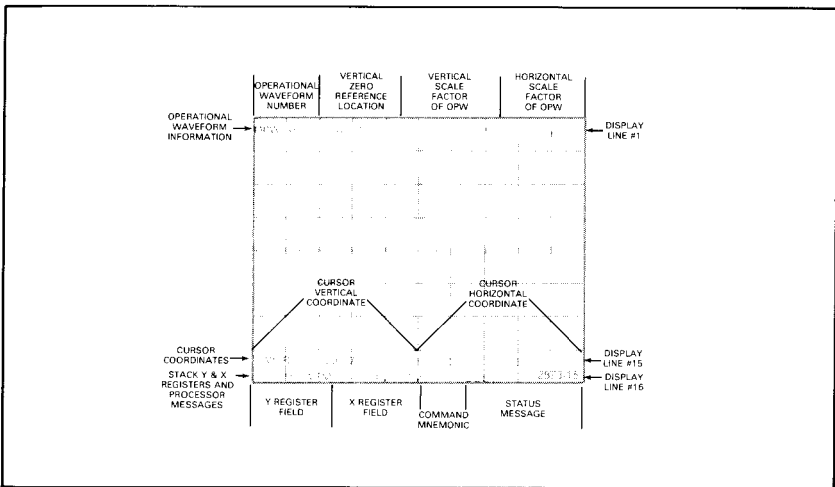

Figure 5-4. Typical character display of STORED mode.

OPERATIONAL WAVEFORM STATUS

Information displayed in the top division of the graticule (line #1) pertains to the operational waveform (OPW) and consists of four fields. The first field of line #1, OPW 0, indicates that the operational waveform is from waveform memory address number 0. The second field, VZR -1, indicates that the waveform's vertical zero location is one division below the center horizontal graticule line. The third and fourth fields are the scale factors which were stored with the waveform (vertical deflection factor and horizontal sweep rate as supplied by the plug-in units), and are usually displayed with scale factor units (e.g., V or S).

CURSOR STATUS

When cursors are on, cursor coordinates, are displayed in display line #15. (See Fig. 5-4.) If one cursor is on, the coordinates given are those of Cursor 1. The first field of this line, VCRD= 23.76mV, is the vertical coordinate of Cursor 1 measured from the VZR and given in scale factor units. The second field, HCRD= 3.66μS, is the horizontal coordinate of Cursor 1 measured from the start of the waveform and given in scale factor units. With both cursors on, the coordinates given are those of Cursor 2 relative to Cursor 1. This is indicated by the Δ (delta) in ΔVCRD and ΔHCRD (called relative coordinates). If the cursors are off, this line is blank.

STACK AND PROCESSOR STATUS

The contents of the Y and X stack registers and status messages are displayed in the bottom line of the display. (The operand stack is discussed in detail in Section 6, Using the Waveform Calculator). The first two fields of this line are the contents of the Y and X stack registers. (For all practical purposes, the contents of the Y register, which usually contains the last contents of the X register, can be ignored while operating the Option 0D instrument). Status messages comprise the remaining fields of this line. These messages include the mnemonic of the command just executed or of the command now executing; plus the execution status messages of BUSY, WARNING, ERROR, STOP IN, END, and PL XXX. (See Programming in section 6 for explanations of the and PL XXX messages).

NUMERIC DISPLAYS

All numeric displays in the STORED mode (except scale factors, which have been previously formatted by the plug-in units) adhere to the general format of:

$$\langle \text{sign} \rangle \langle \text{mantissa} \rangle \langle \text{exponent} \rangle$$

The sign is displayed only for negative numbers (-), and is blank for positive numbers. A zero value is displayed as 0, and up to four mantissa digits in the range of 1.000 through 999.9 are displayed.

If the number is within the range of 1.000×10^{-12} through 999.9×10^{12} , a letter exponent is displayed. See Table 5-1. Numbers outside the range for letter exponents are displayed in the form:

<sign> <mantissa>E<esign><evalue>

where the esign is + if the exponent is positive and - if negative, and the evalue is displayed as a two-digit integer, multiple of 3.

TABLE 5-1
Letter Exponents

Multiplier	Prefix	Symbol
10^{-12}	pico	p
10^{-9}	nano	n
10^{-6}	micro	μ
10^{-3}	milli	m
10^3	kilo	K
10^6	mega	M
10^9	giga	G
10^{12}	tera	T

CURSORS EXERCISE

Cursors are one or two specially identified points of the operational waveform. When the cursors are on, their position on the waveform is identified by intensified points, and their vertical and horizontal coordinates are displayed on the crt. (See Stored Character Display for more information on the cursor coordinates.) The cursors are also used to define portions of the operational waveform for waveform and pulse parameter measurements.

The cursor control keys are located at the lower right edge of the 7854 measurement keyboard (see Fig. B, block 3). The following exercise only illustrates the function and operation of the cursor control keys. Effects of cursor status and position on waveform parameter commands are illustrated by performing the exercises given later in this section under Waveform Parameter Measurements.

POSITIONING THE CURSORS

Perform the procedure for Obtaining a Scope Display given in Section 4, Display Mode Information.

Position the CALIBRATOR signal so that the first positive-going pulse starts at the second vertical graticule line, and the baseline is one division below the center horizontal graticule line.

Set the STORED INTensity control to quarter range.

Press

AVG10

Display

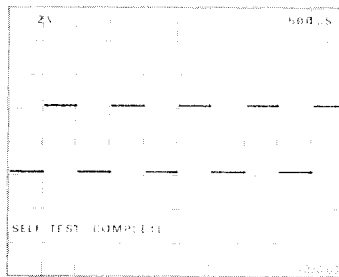

Comments

Calibrator signal and scale factors are stored.

Exercise continues on next page

POSITIONING THE CURSORS (Cont)

Press

STORED

Display

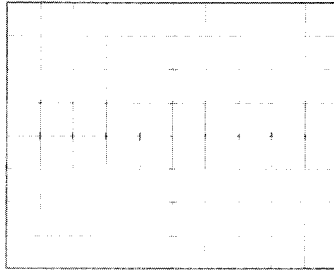

Comments

Stored calibrator signal is displayed.

/ CRS1

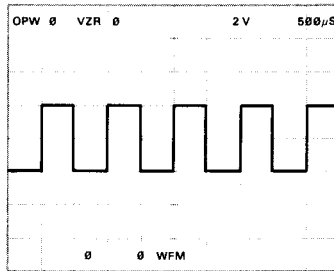

Cursor 1 is turned on. Cursor 1 appears at left edge of display if it has not been moved since the 7854 was turned on, otherwise it appears at its last positioned horizontal location. Cursor coordinates are displayed in line #15.

To move Cursor 1 to the right:

Press

CRS1>

Comments

Cursor 1 moves right. Notice how the coordinate readings change to reflect the new position of the cursor. _____ is issued when Cursor 1 reaches the end of the waveform.

POSITIONING THE CURSORS (Cont)

NOTE

For all manual cursor positioning keys, the initial actuation moves the designated cursor by one point. If you continue to hold the key down, the cursor begins continuous movement, accelerating across the display. When the key is released, cursor movement is immediately halted.

To move Cursor 1 to the left:

Press

CRS1 ←

Comments

Cursor 1 moves to the left. Notice the change in cursor coordinate readings. **COORD ALIGNING** is issued when Cursor 1 reaches the start of the waveform.

To turn on both cursors:

Press

CRS2-1

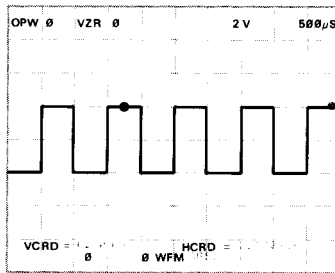
Display**Comments**

Turns on Cursor 2. Relative cursor coordinates express the difference between Cursor 2 and Cursor 1 (identifiable by).

Exercise continues on next page

POSITIONING THE CURSORS (Cont)

Position Cursor 1 to the third vertical graticule line.

To move Cursor 2 left:

Press

CRS2<

Comments

CRS WARNING is issued when Cursor 2 reaches Cursor 1. Cursor 2 cannot be positioned before Cursor 1 on the operational waveform. Notice that the relative coordinates read $\emptyset V$ and $\emptyset S$ indicating both cursors are positioned at the same point.

To move Cursor 2 right:

Press

CRS2>

Comments

Cursor 2 moves to the right. **CRS WARNING** issued when Cursor 2 reaches the right edge of the graticule.

To turn off the cursors:

Press

OFF

Comments

Turning the cursors off does not change their horizontal location. Verify this by pressing **CRS2-1**.

POSITIONING THE CURSORS (Cont)

After turning on both cursors, position Cursor 1 to the left edge of the graticule and Cursor 2 to the center vertical graticule line. Then:

Press**CRS1** >**Comments**

Notice that as Cursor 1 passes through the center vertical graticule line it picks up Cursor 2 and both move toward the right.

CRS1 <

Move Cursor 1 at least one division to the left of Cursor 2.

CRS2 <

CRS WARNING is issued when Cursor 2 meets Cursor 1. Notice that Cursor 2 cannot pick up Cursor 1.

OFF

Turn cursors off.

NEXT EXERCISE BEGINS WITH POWER-UP

WAVEFORM PARAMETER MEASUREMENTS

The keys located in the WFM PARAMETER block at the left of the measurement keyboard (see Fig. B, blocks 1 and 2) cause the processor to compute various scalar parameters of the operational waveform. Basically, two types of parameters are computed: amplitude parameters (with the MAX, MIN, P-P, MID, MEAN, RMS, AREA, and ENERGY commands) and time parameters (with the PER, FREQ, DELAY, WIDTH, RISE and FALL commands). Cursor status and position affect the calculation of these parameters.

The following exercises only illustrate the function and operation of the WFM PARAMETER keys. Refer to Section 9, Command Language, for the specific algorithm used for each computation.

MAKING AMPLITUDE-PARAMETER MEASUREMENTS

Perform the procedure for Obtaining a Scope Display given in Section 4, Scope Display Mode Information.

Set the input coupling switch of the LEFT VERT amplifier unit to ground. Position the trace one division below the center horizontal graticule line.

Press **GND** to set the ground reference level for all measurements made in this exercise.

NOTE

If the GND is not set, the measurements will be taken with reference to the center horizontal graticule line and not necessarily with reference to the 0-volt level of the waveform.

Return the input coupling switch of the LEFT VERT amplifier unit to dc.

Horizontally position the CALIBRATOR signal so that the first positive-going pulse starts at the second vertical graticule line.

Set the STORED INTensity control to quarter range.

NOTE

Cursor status and position affect all voltage parameter measurements as follows: (1) With both cursors off, the measurement spans all stored waveform points; (2) with Cursor 1 on, the measurement spans from (and including) Cursor 1 to the right end of the waveform; and (3) with both cursors on, the measurement spans between (and including) the cursor points.

MAKING AMPLITUDE-PARAMETER MEASUREMENTS (Cont)

Press

AVG10

Display

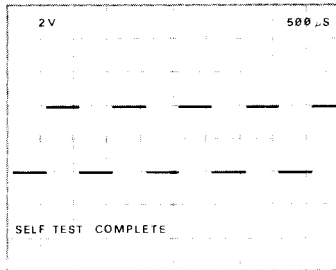

Comments

The calibrator signal is averaged 10 times and stored in waveform memory.

STORED

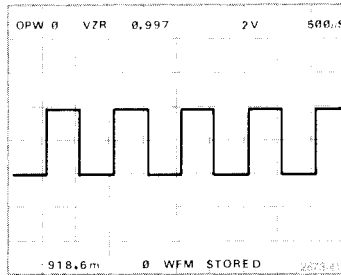

Return to the STORED display mode.

To measure the MAXimum value of the waveform:

Press

MAX

Display

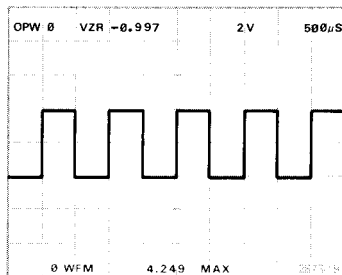

Comments

The maximum value (the stored waveform's most positive point relative to the VZR) is returned to the X register field and the MAX mnemonic is displayed. (The unit of measurement is the same as the vertical scale factor unit.)

Exercise continues on next page

MAKING AMPLITUDE-PARAMETER MEASUREMENTS (Cont)

To measure the MINimum value of the waveform:

Press

MIN

Display

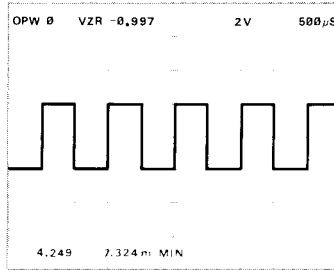

Comments

The minimum value (the stored waveform's most negative point relative to the VZR) is returned to the X register field and the **MIN** mnemonic is displayed.

To measure the Peak-to-Peak value of the waveform:

Press

P-P

Display

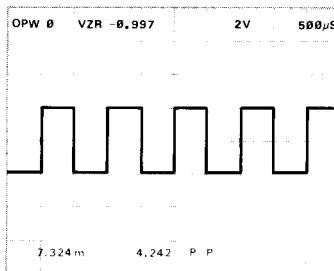

Comments

The peak-to-peak value of the stored waveform is returned to the X register field and the **P-P** mnemonic is displayed. Notice that the P-P value is the difference between MAX and MIN.

To measure the MIDDLE value of the waveform:

Press

MID

Display

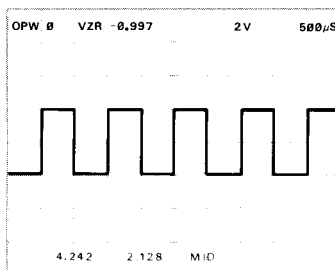

Comments

The middle value is returned to the X register field and the **MID** mnemonic is displayed. The MID value is halfway between MAX and MIN.

MAKING AMPLITUDE-PARAMETER MEASUREMENTS (Cont)

NOTE

When taking the MEAN and RMS measurements, turn on and position the cursors to span an integer number of cycles. For the following examples we have arbitrarily chosen to span three cycles.

To measure the MEAN value of the waveform:

Press

CRS2-1

CRS1>

CRS2<

Display

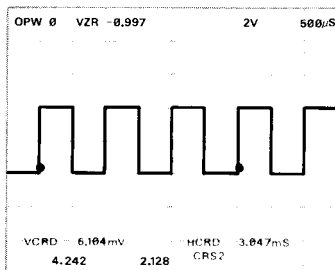

Comments

Turn on and position the cursors as shown.

MEAN

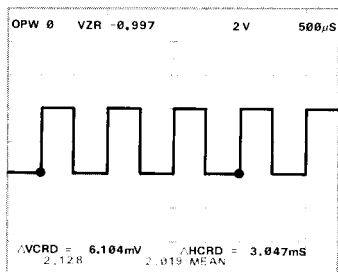

The algebraic mean value of all spanned waveform points is returned to the X register field and the MEAN mnemonic is displayed. (See Section 9, Command Language, for the specific algorithm.)

To measure the Root-Mean-Square of the waveform:

Press

RMS

Display

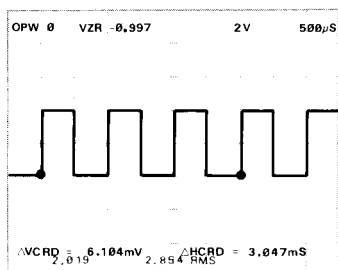

Comments

The root-mean-square value of all spanned waveform points is displayed in the X register field and the RMS mnemonic is displayed. (See Section 9, Command Language, for the specific algorithm.)

MAKING AMPLITUDE-PARAMETER MEASUREMENTS (Cont)

NOTE

When taking AREA and ENERGY measurements turn on and position the cursors to span one cycle of the waveform.

To measure the AREA under the waveform:

Press

CRS1>

Display

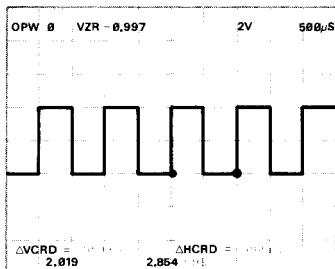

Comments

Position Cursor 1 as shown.

AREA

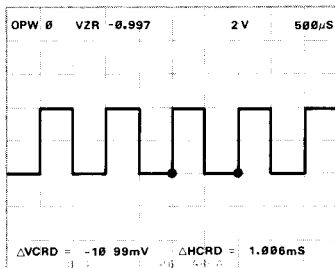

The area under all spanned waveform points is returned to the X register field and the AREA mnemonic is displayed. (See Section 9, Command Language, for the specific algorithm.)

To measure the ENERGY under the waveform:

Press

ENERGY

Display

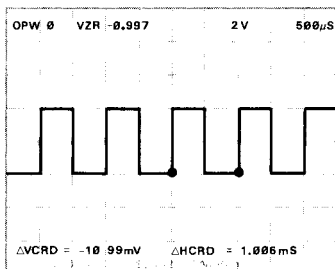

Comments

The energy under all spanned waveform points is returned to the X register field and the ENERGY mnemonic is displayed. (See Section 9, Command Language, for the specific algorithm.)

NEXT EXERCISE BEGINS WITH POWER-UP

MAKING TIME-PARAMETER MEASUREMENTS**NOTE**

For the following measurements, if a point is not located specifically at the designated crossing level, the processor estimates the horizontal crossing location using linear interpolation between the two points adjacent to the crossing level.

Perform steps 1 through 3 of the procedure for Obtaining a Scope Display given in Section 4, Scope Display Mode Information.

Set the B HORIZ time-base unit to 0.5 microsecond/division and triggering to auto mode with ac coupling from the internal source. Set the sweep magnifier to the X10 position.

Rotate the B INTENSITY control until the trace is at a desirable viewing level.

Connect a square wave of approximately 2.5 megahertz from a function generator (recommended type; TEKTRONIX FG 503 Function Generator with TM 500 Power Module) to the input of the LEFT VERT amplifier unit. (Match impedances if necessary.)

Set the LEFT VERT amplifier deflection factor and the function generator output amplitude to display a signal of 4 divisions amplitude on the crt.

Adjust the B HORIZ time-base triggering controls for a stable display triggered on the negative-going slope.

Adjust the B HORIZ position control and the function generator output frequency to obtain a display similar to that shown below for **AVG100**.

Set the STORED INTensity control to quarter range.

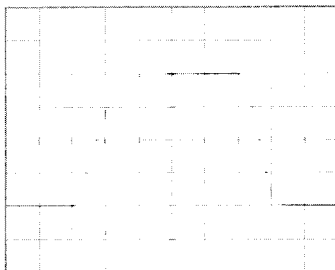
Press**AVG100****Display****Comments**

Store the pulse.

Exercise continues on next page

MAKING TIME-PARAMETER MEASUREMENTS (Cont)

Press

STORED

Display

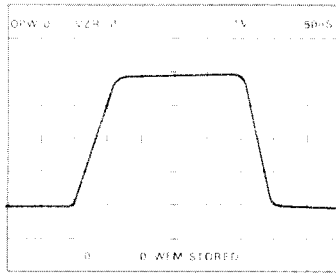

Comments

Display the stored pulse.

CRS2-1

CRS1>

CRS2<

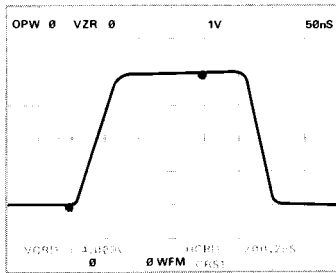

Turn on and position the cursors as shown at the left.

NOTE

For the time-parameter functions the processor computes the horizontal spacing between identified levels of the operational waveform whose vertical positions have certain specified values (i.e., baseline, 50% level, pulse top, etc.). These points and the corresponding measurements are illustrated in Figure 5-5. Refer to this figure throughout the following instructions. Always, for the time-parameter functions, the baseline and pulse top are identified by Cursor 1 and Cursor 2 respectively. If the cursors are off, Cursor 1 (and therefore the baseline) is assumed to be at the left edge of the graticule, and Cursor 2 (the pulse top) at the right edge. If several pulses are displayed, Cursor 2 also identifies the pulse to be measured.

MAKING TIME-PARAMETER MEASUREMENTS (Cont)

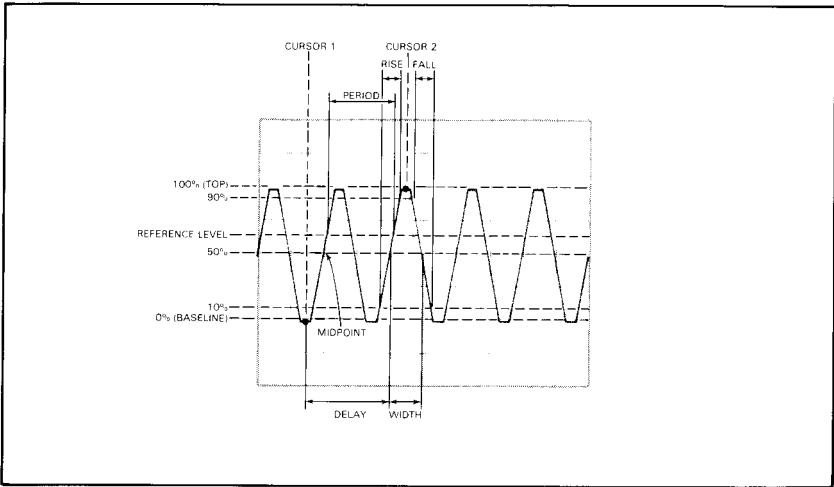

Figure 5-5. Time-parameter relationships.

Measuring a Pulse

To measure the RISE time of the pulse:

Press

RISE

Display

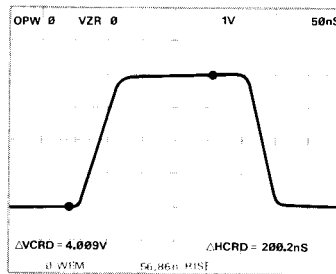

Comments

The rise time is returned to the X register field and RISE mnemonic is displayed.

RISE Operation: The time between the 10% and 90% levels adjacent to the closest 50% level before Cursor 2 is returned to the X register.

RISE Restrictions: If both cursors are on, the VCRD must not be within: $\pm(6E-04) * (\text{vertical scale factor})$, prior to executing the RISE command. RIS ERROR is issued if the restriction is violated.

MAKING TIME PARAMETER MEASUREMENTS (Cont)

To measure the **FALL** time of the pulse:

Press



Display

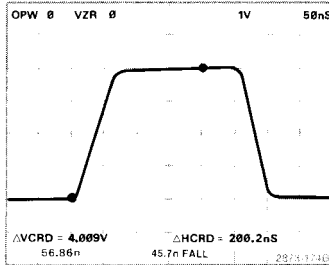

Comments

The fall time is returned to the X register field and **FALL** mnemonic is displayed.

FALL Operation: The time between the 90% and 10% levels adjacent to the first 50% level following Cursor 2 is returned to the X register.

FALL Restrictions: Cursor 2 must be on and the waveform must cross the 90% and 10% levels after Cursor 2. Also, the $\Delta VCRD$ must not be within: $\pm(6E-04) * (\text{vertical scale factor})$, prior to executing the **FALL** command. **FAL ERROR** is issued if either restriction is violated.

To measure the **DELAY** of the pulse:

Press



Display

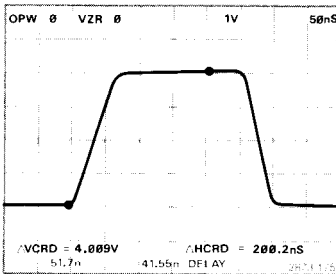

Comments

The delay time is returned to the X register field and **DELAY** mnemonic is displayed.

DELAY Operation: The time from Cursor 1 to the closest 50% level before Cursor 2 is returned to the X register.

DELAY Restrictions: If both cursors are on, the $\Delta VCRD$ must not be within: $\pm(6E-04) * (\text{vertical scale factor})$, prior to executing the **DELAY** command. **DEL ERROR** is issued if this restriction is violated.

MAKING TIME-PARAMETER MEASUREMENTS (Cont)

To measure the WIDTH of the pulse:

Press

WIDTH

Display

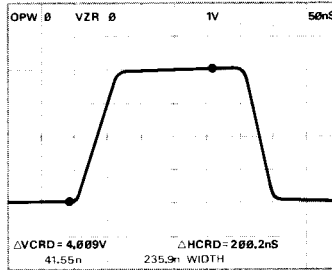

Comments

The width is returned to the X register field and mnemonic is displayed.

WIDTH Operation: The time from the closest 50% level before Cursor 2 to the closest 50% level after Cursor 2 is returned to the X register.

WIDTH Restrictions: Cursor 2 must be on and the waveform must cross the 50% level after Cursor 2. Also, the $\Delta VCRD$ must not be within: $\pm(6E-04) * (\text{vertical scale factor})$, prior to executing the WIDTH command. WID ERROR is issued if either restriction is violated.

Measuring A Pulse Train

Set the B HORIZ time-base time/division to 2 microseconds/division and the sweep magnifier to the X10 position.

Press

AVG100

Display

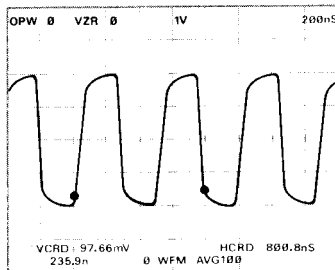

Comments

Store the pulse train.

Exercise continues on next page

MAKING TIME-PARAMETER MEASUREMENTS (Cont)

Press

CRS1>

CRS2

Display

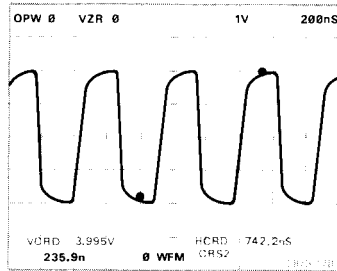

Comments

Position the cursors approximately as shown.

To measure the I

Press

MID

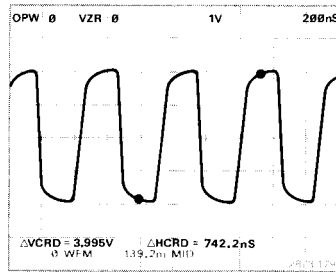

Comments

The processor requires a vertical level of the waveform to be in the X register prior to executing the PER. Since the MID is convenient, we have placed it in the X register.

PER

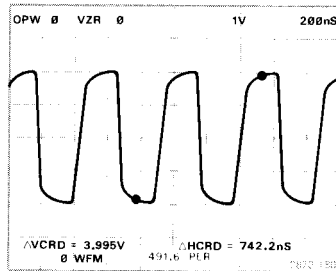

The period is returned to the X register and PER mnemonic is displayed.

PER Operation: The time between the first crossing of the waveform across the level specified in the X register to the next crossing of the specified level, in the same direction, is returned to the X register.

The search for the crossing begins at the left end of the specified interval. Any place where the waveform touches the crossing level, but does not actually cross, is detected as a crossing in either direction.

MAKING TIME-PARAMETER MEASUREMENTS (Cont)

PER Restrictions: The X register must contain a constant representing a vertical level which the waveform crosses twice in the same direction (either positive-going or negative-going), between the cursors if they are on. PER ERROR is issued if the restriction is violated.

To measure the **FREQUENCY** of the pulse train first:

Press

MEAN

Display

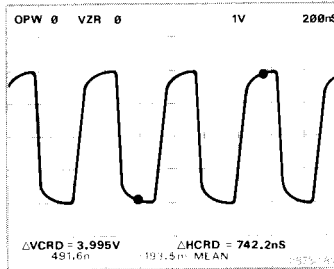

Comments

The processor requires a vertical level of the waveform to be in the X register prior to executing the **FREQ** command. In this example we have used the **MEAN** level.

FREQ

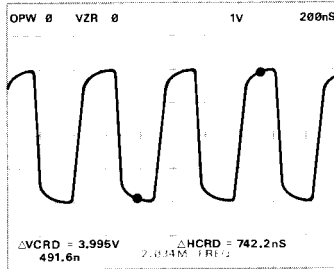

The frequency is returned to the X register and **FREQ** mnemonic is displayed.

FREQ Operation: The processor computes the period, as described above, then returns the reciprocal of the period to the X register.

FREQ Restrictions: The X register must contain a constant representing a vertical level which the waveform crosses twice in the same direction. **FRE ERROR** is issued if the restriction is violated.

NEXT EXERCISE BEGINS WITH POWER-UP

BOTH DISPLAY MODE

The BOTH display combines the real-time waveform(s) of the SCOPE mode and the stored waveform and character display of the STORED display mode. The real-time waveform of the BOTH mode is controlled by the associated plug-in units and the stored waveform and character display is controlled by the processor. This display mode is used primarily for the comparison of real-time and stored waveforms.

SELECTING THE BOTH DISPLAY MODE

Perform the procedure for Obtaining a Scope Display given in Section 4, Scope Display Mode Information.

Position the CALIBRATOR signal so that the first positive-going pulse starts at the second vertical graticule line, and so the baseline is at the center horizontal graticule line.

Set the STORED INTensity control to quarter range.

Press

AVG100

Display

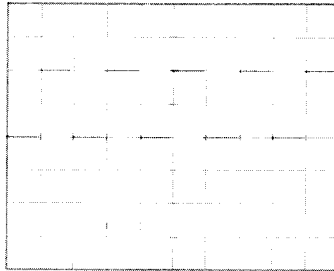

Comments

Average and store the calibrator signal.

Reposition the real-time CALIBRATOR signal so that the pulse tops are one division below the center horizontal graticule line.

Set the time-base unit in the B HORIZ compartment to 1 millisecond/division.

Press

BOTH

Display

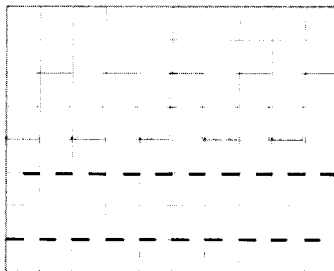

Comments

Both the real-time CALIBRATOR signal and the stored calibrator signal are displayed on the crt. Character information is the same as previously described for STORED display; no real-time readout from the plug-in units is displayed.

SELECTING THE BOTH DISPLAY MODE (Cont)

NOTE

In all display modes of the Option 0D instrument, all commands in the WFM ACQUISITION, WFM PARAMETERS, and CURSORS blocks on the 7854 measurement keyboard, function as previously described. The real-time waveform is controlled by the plug-in units as described in Section 4, Scope Display Mode Information.

NEXT EXERCISE BEGINS WITH POWER-UP

7854

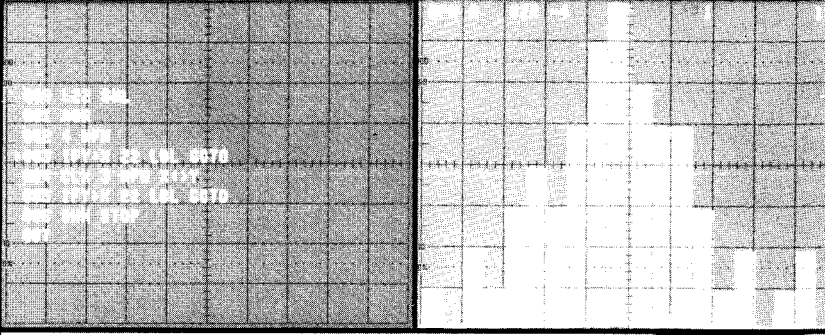

Using the Waveform Calculator

The Waveform Calculator keyboard provides accessibility to increased processing capabilities for stored waveform manipulation and measurement, and for numeric computations. And in addition to the three display modes available with the measurement keyboard, the Waveform Calculator provides command programming which allows a repetitive command sequence to be performed automatically by the processor.

This section builds upon the information presented in sections 1 through 5 of this manual and should be read in sequence.

This section discusses only the increased capabilities available with the Waveform Calculator and is divided into two subsections:

1. Stored Display Mode Information—additional information pertaining to the STORED display mode using the Waveform Calculator; and
2. Programming—a discussion of programming using the Waveform Calculator.

STORED DISPLAY MODE INFORMATION

In addition to displaying real-time waveforms and readout (as described in Section 4, Scope Display Mode Information), the crt can display various aspects of the processor's data memory—stored constants, stored waveforms, operational waveform (OPW) scale factors, operand stack contents, and program status—in the STORED display mode. Also, the **BOTH** display mode is available for comparing real-time and stored waveforms. The Waveform Calculator keyboard is the primary port to input operands and programs to the processor, and operates similarly to hand-held programmable stack-oriented calculators using Reverse Polish Notation (RPN). (Programming is explained under Programming later in this section.)

This subsection has been divided further into Mathematical Calculations and Waveform Processing. Stack operation, processor operation (RPN), and numeric functions and limitations are explained under Mathematical Calculations. Waveform Processing explains waveform storage, data memory, and waveform manipulation.

MATHEMATICAL CALCULATIONS

Plug-in units are not necessary when only mathematical calculations are to be performed, since only the Y and X register fields (on the STORED or BOTH display) are observed during execution of mathematical functions.

OBTAINING A STORED DISPLAY WITHOUT WAVEFORMS

Although mathematical calculations can also be performed and observed in the **BOTH** display mode, the STORED display mode is used here. To enter the STORED display mode:

1. Connect the Waveform Calculator to the 7854 Oscilloscope mainframe (POWER switch off) as described under Installation in Section 1, Introduction.
2. Connect the 7854 (POWER switch off) to a power source that meets the voltage requirements of the instrument. If the available line voltage is outside the setting limits of the LINE VOLTAGE SELECTOR switch (on the mainframe rear panel), see Operating Power Information under Installation in section 1.

OBTAINING A STORED DISPLAY WITHOUT WAVEFORMS (Cont)

3. Set the front-panel controls as follows:

- GRAT ILLUM Fully counterclockwise
- READOUT Intensity Quarter range
- STORED INTensity Fully counterclockwise
- A INTENSITY Fully counterclockwise
- FOCUS Midrange
- B INTENSITY Fully counterclockwise
- POWER On (locked in)
- CALIBRATOR 4 V
- VERTICAL MODE LEFT*
- A TRIGGER SOURCE VERT MODE
- HORIZONTAL MODE B*
- VERT TRACE SEPARATION (B) Midrange
- B TRIGGER SOURCE VERT MODE

*These controls are automatically set to the specified positions at power turn on. See Power-On Conditions in section 1.

4. Press the **STORED** key on either keyboard. (Identically named keys on the measurement and Waveform Calculator keyboards perform the identical function.)
5. Adjust the READOUT intensity control until the readout is at a desirable viewing level (about quarter range).

THE STACK

The stack is a special storage structure primarily used to provide operands for commands, and as the target for results from the processor. The displayed Y and X registers are two of the five data registers which constitute the stack. These registers have been labeled W, T, Z, Y, and X, and are pictorially represented as:

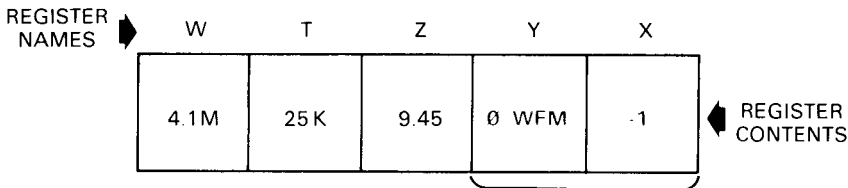

Displayed in STORED mode as the first two readout fields of the bottom line.

Each stack register may contain either a numerical constant (displayed in numeric format) or a waveform memory address (displayed as n WFM). (The actual waveform data remains in the designated waveform memory.) All data flow into and out of the stack is via the X register.

To accommodate a new data item, the previous contents of each register is first moved to the next register left, then the new data is entered into the X register. This is called "pushing the stack" and is illustrated in Figure 6-1B and C.

When a new data item is required from the stack, the stack is "popped" as shown in Figure 6-1D and E. First, the data item in the X register is "popped" to the processor, then the data in the remaining stack registers is copied into the next register right. Notice that the contents of the W register remains unchanged.

NUMERIC ENTRY

Numbers are entered in the stack via the X register, by pressing the numeric keys (\cdot , **EEX** , and \emptyset through **9**), just as though you were writing on a piece of paper. The decimal point must be keyed in if it is part of the number; however, any additional decimal point entered after the first will be ignored and a warning¹ will be issued. Any sequence of digits, up to a total of twelve characters, may be entered as a mantissa; but the processor will ignore any additional digits entered and will issue a warning¹.

Initially the mantissa is positive, but CHS (Change Sign) commands can be issued at any time during the mantissa entry. Any number of CHS commands may be issued during entry of the mantissa and each will reverse the existing sign of the mantissa. Mantissa entry is terminated by EEX (Enter Exponent), ENTER, or any non-numeric command (except CHS, RUN, STEP, STOP, or PAUSE).

When working with numbers which are either too large or too small for the normal mantissa limits, using an exponent is particularly advantageous. To enter an exponent, press **EEX** following mantissa entry or a non-numeric command, and key in the desired exponent. (If a mantissa is not entered prior to an EEX command, a default mantissa of "1" is assigned and displayed). Any number of digits may be entered for the exponent, but only the last two are retained by the processor. Decimal points or additional EEX commands issued during exponent entry are ignored by the processor and a warning¹ is issued. The exponent sign is initially positive, but any number of CHS commands may be issued at any time during exponent entry to reverse the existing exponent sign. Exponent entry is terminated by the ENTER command or by any non-numeric command except CHS, RUN, STEP, STOP, or PAUSE.

¹The warning message of XXX WARNING is not displayed for this warning.

A. The Stack.

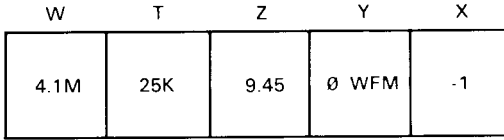

B. Pushing a new data item (3.414) into the stack.

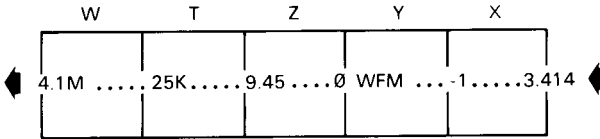

C. The stack after being pushed. Notice that the original contents of the W register are lost.

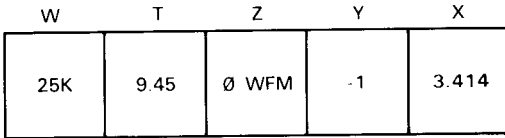

D. Data item (3.414) is popped to an outside target as required by the processor.

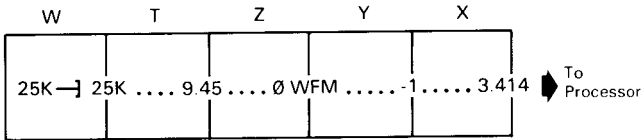

E. The stack after being popped. Notice that the contents of the W register remain unchanged, but its data has been duplicated in the T Register.

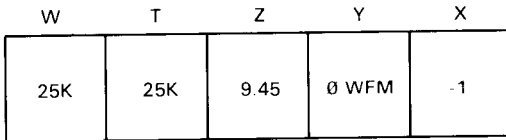

2873-44

Figure 6-1. A demonstration of stack "pushing" and "popping".

When numeric entry is terminated, the mantissa is rounded to a maximum of four significant digits within the range of 1.000 through 999.9, and the exponent is displayed as a letter if within the range of 10^{12} to 10^{-12} . At this point, the value of the number is:

$$\text{(rounded mantissa)} * 10^{\text{(displayed exponent)}}$$

The location of the keys demonstrated in the following exercises are shown in Figure D, blocks 2 and 8 at the front of this manual.

KEYING IN NUMBERS

Perform the procedure for Obtaining a Stored Display Without Waveforms given earlier in this section.

Operands are keyed into the X register by pressing the numeric keys in the sequence used when writing on paper. For example, to key in the number 851.25:

Press	X Register Field	Comments
8	8	Mantissa sign is blank indicating a positive number.
5	85	Successive mantissa digits entered are displayed to the right of existing digits. Notice that each character is generated by the associated key.
1	851	
.	851.	The decimal point is entered as part of the mantissa. Additional decimal points issued are ignored and a warning ¹ is given.
2	851.2	Up to a total of 12 characters (digits + decimal point) may be keyed in. Additional characters entered are ignored and a warning ¹ is given.
5	851.25	

¹The warning message of XXX WARNING is not displayed for this warning.

KEYING IN NUMBERS (Cont)

NOTE

If the shift, , command is issued during numeric entry the processor will blank 5 characters of the X register display to the right of the center vertical graticule line and will display the here. The value of the number is not affected and the display is returned to normal following a CLf command.

ENTERING NEGATIVE NUMBERS

To key in a negative number, press the keys for the number, then press **CHS** (Change Sign). The number, preceded by a minus sign (-), will be displayed in the X register.

To change 851.25 now in the X register to a negative number:

Press	X Register Field	Comments
CHS	-851.25	Notice that only the minus sign is displayed; positive numbers do not have a displayed sign.

The sign of a number may be changed any number of times, and at any time during mantissa entry.

CLEARING THE X REGISTER

If a mistake is made while keying in a number, clear the entire number string by pressing **CLX** (Clear X Register). Then enter the correct number.

For example, you have entered -851.25 when you should have entered -814.25:

Press	X Register Field	Comments
CLX		The stack is popped; mnemonic is displayed.
814.25 CHS		The correct number is entered.

NOTE

The CLX command does not reset the X register to 0; it merely pops the stack. In the example, the 0 came from the Y register.

PERFORMING TWO-OPERAND FUNCTIONS WITH CONSTANTS

Two-operand functions are key commands that must have two numbers entered in order for the operation to be performed. Examples of two-operand functions are the $-$, $+$, $*$, and $/$ arithmetic commands.

To place two constants into the stack and perform an operation:

- a. *Key in the first number.*
- b. *Press **ENTER** to separate the first constant from the second. The first constant may, if necessary, be rounded by the processor at this time.*
- c. *Key in the second number.*
- d. *Press the arithmetic function key to perform the operation.*

NOTE

When a function key is pressed, the processor (if not busy) immediately executes that function.

To illustrate, add 12 and 13 by pressing **1**, **2**, **ENTER**, **1**, **3**, and **+**. Notice that the stack is popped twice to remove the operands and . The result of 25 is then pushed to the X register.

The other arithmetic functions are similarly performed.

NOTE

Hereafter in this manual when numbers are entered into the stack they will not be represented as individual keystrokes.

To Perform:	Press:	X Register:
25 - 13	25 ENTER 13 -	
13 * 3	13 ENTER 3 *	
12 / 4	12 ENTER 4 /	

Arithmetic Function Operation

- +: The contents of the Y register is added to the contents of the X register; result is returned to the X register.
- : The contents of the X register is subtracted from the contents of the Y register; result is returned to the X register.
- *: The contents of the X register is multiplied by the contents of the Y register; result is returned to the X register.
- /: The contents of the Y register is divided by the contents of the X register; result is returned to the X register. A warning¹ is issued if the divisor is 0 and the result is set internally to the largest representable binary number and displayed as eight asterisks preceded by the appropriate sign (i.e.,).

PERFORMING CHAIN CALCULATIONS

During chain calculations only one operation at a time is performed, and the results are displayed as you calculate. The stack stores the intermediate results until needed, and then inserts them into the calculation. This makes all complex calculations merely a series of one- and two-operand functions.

For example, solve $(9 + 5) / 2 =$

If you were to work the problem on paper you would first calculate the intermediate result of $(9 + 5)$. . .

$$\begin{array}{r} \cancel{(9 + 5)} / 2 \\ 14 / 2 \end{array}$$

. . .and then you would divide the intermediate result by 2. . .

$$14 / 2 = 7$$

To work this problem on the 7854, you proceed the same way.

Solve for the intermediate result first:

NOTE

Press **CLX** before proceeding so that your stack display will agree with that shown in this exercise.

¹The warning message of XXX WARNING is not displayed for this warning.

PERFORMING CHAIN CALCULATIONS (Cont)

Press	Display		Comments
	Y Register Field	X Register Field	
9	0	9	Enter the first number. (The Y register contains the results of the last function performed.)
ENTER	0	9	Separate the two numbers. Notice that when the number was being entered it was left-justified in the X register field, and after numeric entry is terminated it is right-justified. (ENTER mnemonic is displayed.)
5	9	5	Enter the second number.
+	0	14	Intermediate result. (+ is displayed.)

Now solve for the final result:

NOTE

The **ENTER** does not need to be pressed to separate the intermediate result from the next number keyed in, since the processor assumes digits keyed in immediately after performing any function are a new entry.

Press	Display		Comments
	Y Register Field	X Register Field	
2	14	2	The intermediate result is pushed to the Y register when the new entry is made.
/	0	7	Pressing the function key divides the intermediate result by the new number and returns the result to the X register.

PERFORMING CHAIN CALCULATIONS (Cont)

NOTE

The results of any mathematical function are displayed in the X register field.

Problems which are even more complex can be solved in the same manner by keeping the following rules in mind:

1. Reduce the problem to a series of one- and two-operand functions.
2. Separate the numbers of a two-operand function by using the ENTER command unless one of the numbers is an intermediate result.
3. Pressing any function key immediately performs the function.
4. Intermediate results are accumulated in the stack and inserted into the problem on a last-in, first-out basis.

To illustrate, let's solve the following problem:

$$[(12 * 2.67) - 4] + \frac{2}{(0.707 * 15)} - \sqrt{1.414} =$$

First, rewrite the problem in a serial fashion of one- and two-operand functions:

$$\{(12 * 2.67) - 4\} + \{2 / (0.707 * 15)\} - \sqrt{1.414} =$$

Now solve for the intermediate results:

Press12 **ENTER**2.67 ***** 4 **-**2 **ENTER**.707 **ENTER**15 ***** **/**1.414 **SQRT****Comments**

The first intermediate result of **28.04** is displayed in the X register.

The second intermediate result of **188.6m** is displayed. Notice that the first intermediate result is now in the Y register.

The third intermediate result of **1.189** is displayed in the X register.

PERFORMING CHAIN CALCULATIONS (Cont)

Now complete the problem by performing the operations between the intermediate results in a right-to-left sequence:

Press



Comments

The final result of **27.04** is displayed in the X register.

NEXT EXERCISE BEGINS WITH POWER-UP

KEYING IN EXPONENTS

When working with numbers which are either too large or too small for the mantissa limits of 1.000 to 999.9, enter the number using an exponent (power of 10). To enter an exponent, press **EEX** (Enter Exponent) following mantissa entry or any non-numeric command. If a mantissa is not entered prior to an **EEX** command, a default mantissa of 1 is assigned and displayed. This is useful when keying in exact powers of 10. For example, to key in 1 million (10^6) simply press **EEX** 6.

If more than two digits are keyed in following an EEX command, only the last two are retained and displayed.

The exponent sign can be changed any number of times, anywhere during entry of the exponent, by pressing **CHS** .

Although exponents can be entered as any power of 10, they are displayed as a multiple of 3 following termination of the exponent entry state. Exponents between the multiplier range of 10^{-12} and 10^{12} are displayed with letters, while those outside this range are displayed as a 2-digit integer which is a multiple of 3. The exponent letters, listed in Table 5-3, appear directly to the right of the mantissa upon termination of numeric entry or after a computation.

Multiply the 1 million previously entered by 1000 by pressing **ENTER**, 1000 , *****. Notice that the exponent is displayed as a G; the processor automatically maintained the exponent as a multiple of three by shifting the decimal point.

When a number resulting from a calculation exceeds 9.999×10^{99} in magnitude, it is displayed as 9 asterisks (******) preceded by the mantissa sign. When the numeric result is equal to or less than 1.000×10^{99} , it is displayed as 0.000**** (preceded by the mantissa sign). In both cases the value is internally maintained for use in further calculations.

USING THE STACK

The **STACK** commands on the Waveform Calculator allow the user to view and rearrange the contents of all registers in the stack. The function and operation of these commands (**CLS**, **CLx**, **ROLL**, $x \leftrightarrow y$, and **ENTER**) are illustrated in the following exercises. Also demonstrated are the **SQRT**, **EXP**, **LN**, **SGN**, and **ABS** functions. (See Fig. D, blocks 2 and 4 for the location of the keys demonstrated in the following exercises.)

REVIEWING STACK CONTENTS

The **ROLL** command allows you to review the stack contents or to shift data within the stack.

Perform the procedure for Obtaining a Stored Display Without Waveforms given earlier in this section.

To observe the **ROLL** function, first load the stack with the numbers 1 through 5 by pressing:

1, **ENTER**, 2, **ENTER**, 3, **ENTER**, 4, **ENTER**, 5

The stack is now loaded with the numbers you keyed in and looks like:

W	T	Z	Y	X
1	2	3	4	5

Each time the **ROLL** command is given, the stack contents shift circularly right by one register and the contents of the X register is rotated into the W register.

Press **f** **ROLL** and the stack contents are "rolled" to:

W	T	Z	Y	X
5	1	2	3	4

Notice that only the contents of the registers are shifted; the registers maintain their positions.

Press the **f** **ROLL** sequence four more times to return the data to their original registers.

EXCHANGING X AND Y

The $x \leftrightarrow y$ (X Exchange Y) command exchanges the contents of the X register with the contents of the Y register without affecting the other registers in the stack. For example, with the data intact from the previous **ROLL** exercise, pressing $x \leftrightarrow y$ changes the stack from this. . .

W	T	Z	Y	X
1	2	3	4	5

to this. . .

W	T	Z	Y	X
1	2	3	5	4

Pressing $x \leftrightarrow y$ again will return the numbers in the X and Y registers to their original positions.

CLEARING THE STACK

To clear all five registers of the stack, press  **CLS** (Clear Stack). This replaces all data contained in the stack with zeros:

W	T	Z	Y	X
0	0	0	0	0

Clearing the stack before starting a new calculation is not necessary since the processor will push the stack before entering a new number.

You can verify that the stack has been cleared by using the **ROLL** command to review the stack contents.

USING THE ENTER COMMAND

When a number is keyed in, the stack is pushed and the new number is then written into the X register. In order to key in a second number, you must separate the digits of the first number from the digits of the second by terminating the numeric entry state of the processor. This is done with the **ENTER** command.

USING THE ENTER COMMAND (Cont)

For example, key in the number 45 and the stack looks like:

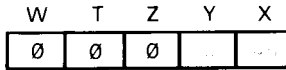

Press **ENTER** .

Numeric entry is terminated (as indicated by the right shift of the X register contents) and the stack is prepared for a new number. Therefore, when you key in the second number of 48 the stack contents change from this. . .

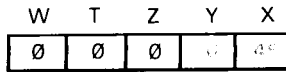

to this. . .

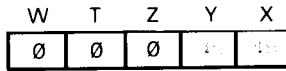

Notice that the stack is pushed at the beginning of numeric entry so that there is no need for the ENTER command to also push the stack. However, if the processor is not in the numeric entry state when an ENTER command is issued (e.g., an arithmetic function key was just pressed), the stack is pushed and the contents of the X register remain unchanged. This is useful for either performing an arithmetic function upon an intermediate result, for maintaining and separating the first intermediate results from a second, or for performing a two-operand function when the two operands are identical.

For example, to square 48: press **ENTER** , **ENTER** , ***** , and the stack changes through this. . .

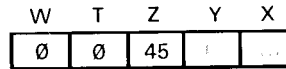

to this. . .

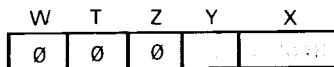

OBSERVING STACK OPERATION WITH SINGLE-OPERAND FUNCTIONS

Single-operand functions (SQRT, EXP, LN, ABS, and SGN) are performed upon the contents of the X register only and not upon the contents of the Y, Z, T, or W registers.

The SGN (Signum) and ABS (Absolute Value) commands alter the operand in the X register. The SGN function is most useful when performed on a waveform and is used to indicate whether the contents of the X register (constant or referenced waveform) are greater than, equal to, or less than zero. These three states are indicated by 1, 0, and -1, respectively. For example, to obtain the signum of -20: press 20, **CHS**, **SGN**. The result of indicates that the original value was less than zero.

The absolute value of a constant is the magnitude of the constant without reference to the sign. To obtain the absolute value of the -20: press 20, **CHS**, **ABS**. The result of 20 is given in the X register.

To obtain the square root of a number in the X register, press **SQRT**. For example, to find the square root of 25: press 25, **SQRT**. The result is 5.

NOTE

A SQR WARNING is issued if the contents of the X register are negative prior to executing the SQRT command, and the square root of the magnitude is returned.

To compute the natural logarithm ($\log_e X$) of the number in the X register, press **LN**. For example, to obtain the natural log of 8: press 8, **LN**. The result is

NOTE

A LN WARNING is issued if the contents of the X register is \leq prior to the LN command.

The exponential function is computed by raising e (2.718) to the power of the number in the X register. For example, to compute e^8 : press 8, **EXP**. The result of 2.981 is given in the X register.

Exercise continues on next page

Stored waveform data is not lost until a command is executed which either changes the value of the waveform points or of the stored scale factors. Until this occurs, the original waveforms can be recovered by issuing another **>P/W** command to restore the originally selected value. However, the stack contents, display status, and OPW number are not recoverable.

WAVEFORM ACQUISITION AND DATA STORAGE

The Waveform Calculator allows one or two real-time waveforms to be acquired into waveform memory with the use of the **AQR** or **AQS** commands. To do so, however, no more than two real-time waveforms may be selected for display; also, no plug-in chop modes are permitted prior to issuing the command. When only one real-time waveform is selected for display it is stored in waveform memory \emptyset . When two waveforms are stored in this manner, use the following rules to determine which of the selected real-time waveforms is stored in waveform memory \emptyset (\emptyset WFM) and which is stored in waveform memory 1 (1 WFM):

1. If the VERTICAL MODE switch is in either ALT or CHOP to select two real-time waveforms for display, \emptyset WFM is from the LEFT VERT amplifier unit and 1 WFM is from the RIGHT VERT amplifier unit.
2. If the selected amplifier plug-in unit (either LEFT VERT or RIGHT VERT) is in the alternate mode, \emptyset WFM is from channel 1 and 1 WFM is from channel 2 of the selected amplifier unit.
3. If the VERTICAL MODE switch is in ADD and either vertical amplifier is in the alternate mode to select two real-time waveforms for display, \emptyset WFM is channel 1 of the alternating amplifier added to the other vertical amplifier input signal, and 1 WFM is channel 2 of the alternating amplifier added to the other vertical amplifier input signal.
4. If the HORIZONTAL MODE switch is in either ALT or CHOP to select two real-time waveforms for display, \emptyset WFM is from the B HORIZ time-base unit and 1 WFM is from the A HORIZ time base.

Scale factors are stored with the appropriate waveform component whenever possible. Refer to the information given under Waveform Storage Considerations in Section 5, Using the Measurement Keyboard, for further details on scale factor acquisition.

When using an Average command to store a waveform, remember that only one real-time waveform can be selected for display prior to AVG execution. *Also, since the processor uses 1 WFM memory space as working storage to perform the AVG command, any waveform stored in 1 WFM will be lost unless it is copied into another waveform memory using the **>WFM** (Copy to Waveform Memory) command.*

The following exercises only illustrate the function and operation of the WFM ACQUISITION and DATA STORAGE commands (except CNS and >CNS) and must be sequentially performed in order to obtain results similar to those shown. (The CNS and >CNS commands were previously demonstrated under Using the Constant Registers earlier in this section.) Figure D, blocks 10 and 15 shows the location of the keys demonstrated in the following exercises.

OBSERVING THE WAVEFORM MEMORIES AT POWER-UP

Perform the procedure for Obtaining a Scope Display in Section 4, Scope Display Mode Information.

Position the CALIBRATOR signal so that the first positive-going pulse starts at the second vertical graticule line, and so the square wave is centered around the center horizontal graticule line.

Set the STORED INTensity control to quarter range.

To observe the power-up conditions of the waveform memories:

Press

STORED

Display

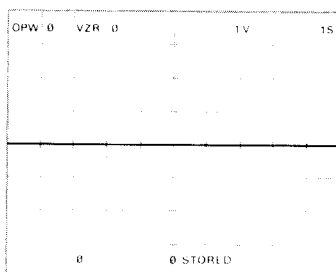

Comments

The power-up condition of 0 WFM is displayed: All point values are set to 0, VZR is set to 0, and the scale factors are set to 1V and 1S. All stack registers power-up to 0.

P/W

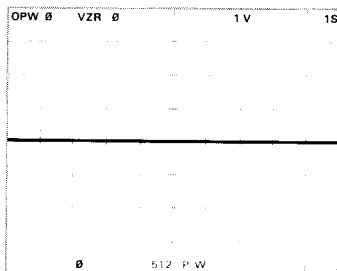

The waveform resolution register powers-up to a setting of 512 as presently displayed in the X register; therefore, the waveform memories are organized as presented in Table 6-1 allowing 4 waveforms to be stored with the standard 7854 instrument.

Exercise continues on next page

OBSERVING THE WAVEFORM MEMORIES AT POWER-UP (Cont)

NOTE

Waveform memories 0 and 1 (0 WFM and 1 WFM) should be used only for transitory storage of waveforms since 1 WFM is used for working storage during Average commands and both memories are used to store newly acquired waveforms with dual-trace acquisition. In addition, computed waveforms are always stored in 0 WFM.

Press	Display	Comments
1 WFM	<p>The display shows a grid with a horizontal line across the middle. At the top, it reads 'OPW 1', 'VZR 0', '1 V', and '1 S'. At the bottom, it reads '512', '1 WFM', and 'WFM'.</p>	<p>The power-up condition of 1 WFM is displayed. The OPW reading has changed to reflect that 1 WFM is now displayed even though the change is not perceptible since the information in each waveform memory is identical at this time.</p>
10 WFM	<p>The display shows a grid with a horizontal line across the middle. At the top, it reads 'OPW 1', 'VZR 0', '1 V', and '1 S'. At the bottom, it reads '1 WFM', '10! WFM', and 'ERROR'.</p>	<p>WFM ERROR is issued because 10 WFM is not a valid waveform memory address with the present conditions.</p>

WFM Restrictions: The X register must contain a constant which (when rounded) is an integer from 0 to the maximum waveform memory address available with the present system conditions prior to executing the WFM command. WFM ERROR is issued if the restriction is violated.

SETTING THE GROUND REFERENCE (Cont)

GND Operation: 128 points of the real-time waveform are acquired as described for the AQR command in section 5. Then the processor computes the algebraic mean value of the acquired points (relative to the center horizontal graticule line) and stores this in the ground reference register. The contents of waveform memory are not changed. If no points have been acquired, due to a premature termination via the STOP command, the ground reference is set to 0. This process is then repeated for the second waveform. (Note that at power-up the vertical zero reference, VZR, is set to the center horizontal graticule line.)

GND Restrictions: No more than two real-time waveforms, and no plug-in unit chop modes, are permitted prior to issuing a GND command. GND ERROR is issued if either restriction is violated.

ACQUIRING TWO WAVEFORMS

To demonstrate how to simultaneously acquire two real-time waveforms, first return the input coupling switch of the LEFT VERT amplifier to dc. Then set the A HORIZ time-base unit to 1 ms/div, the HORIZONTAL MODE switch to ALT, and the VERTICAL MODE switch to LEFT. Press **SCOPE**. Set the A INTENSITY for a visible display. Use the VERT TRACE SEPARATION (B) control to position the baseline of the B HORIZ square wave to the center horizontal graticule line. (If necessary, adjust the A HORIZ time base to position the A display to begin at the first vertical graticule line.)

Press

AQR

Display

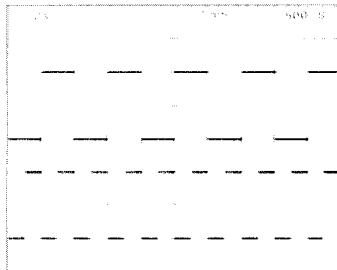

Comments

Both displayed real-time CALIBRATOR signals are acquired and stored in waveform memory according to the previously discussed rules. (See Waveform Acquisition and Data Storage.) AQR WARNING is issued if default scale factors are assigned, if non-unique scale factors are detected (e.g., real-time ADD mode selected), if more than 5% contiguous points are unfilled, or if the command is prematurely terminated with the STOP command.

ACQUIRING TWO WAVEFORMS (Cont)

AQR Restrictions: No more than two real-time waveforms and no plug-in unit chop modes are permitted prior to issuing an AQR command. AQR ERROR is issued if either restriction is violated.

Press

STORED

Display

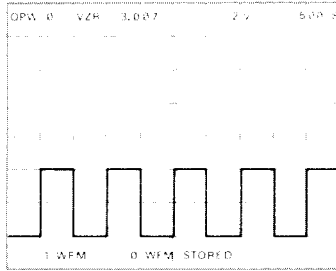

Comments

The stored calibrator signal from the B HORIZ sweep is shown displayed with the previously set ground reference (VZR 3.007) information.

1 **WFM**

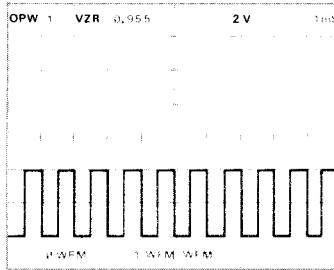

The stored calibrator signal from the A HORIZ sweep is displayed. This waveform was stored in 1 WFM when the previous AQR was issued, and is referenced to the ground setting (VZR) or 0.955.

AVERAGING A WAVEFORM

By using the AVG command available on the Waveform Calculator keyboard, the operator can designate the number of Averages to be done to a repetitive real-time waveform.

NOTE

The noise-reduction characteristic of the AVG command is demonstrated in the exercise for Averaging A Waveform in Section 5, Using the Measurement Keyboard.

To demonstrate the AVG command by averaging the CALIBRATOR signal 75 times, first return to the SCOPE display mode by pressing **SCOPE**. Then set the HORIZONTAL MODE switch to B and vertically center the CALIBRATOR signal around the center horizontal graticule line. Then:

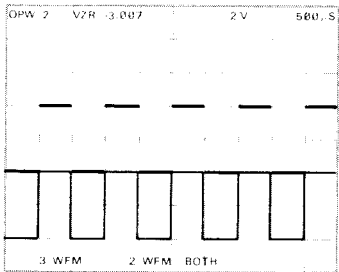
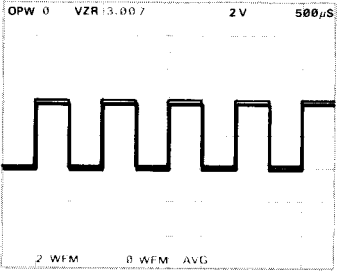
Press	Display	Comments
<p>SCOPE</p>		<p>The real-time CALIBRATOR signal and the contents of 2 WFM are displayed. (The SCOPE display mode is used here to aid in understanding the AVG operation.)</p>
<p>75 AVG</p>		<p>Both the real-time and the newly averaged calibrator signals are displayed. (To verify this, vary the LEFT VERT position control.) AVG WARNING is issued if more than 5% contiguous points are unfilled, or if the command is prematurely terminated with a STOP.</p>

AVG Restrictions: The X register must contain a constant which (when rounded) is from 1 to 1023 inclusive, and only one real-time waveform is permitted, prior to issuing any AVG command. **AVG ERROR** is issued if either restriction is violated.

AVERAGING A WAVEFORM (Cont)

To observe the effects of an Average command on 1 WFM:

Press

STORED

Display

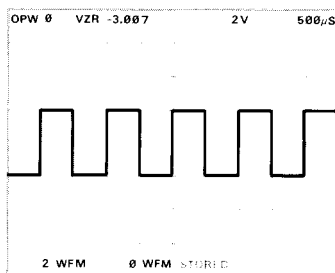

Comments

Return to STORED display mode. (The real-time signal is no longer displayed.)

1 WFM

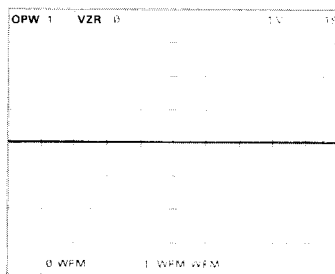

The contents of 1 WFM are displayed. Notice that 1 WFM is returned to the power-up condition after having been used as working storage by the processor for the AVG command. However, since we had duplicated the waveform data into 3 WFM prior to the AVG, the data has not been lost.

OBSERVING EFFECTS OF A >P/W

Review the present contents of each of the four waveform memories (available in the standard 7854 with the present conditions):

Press

0 WFM

Display

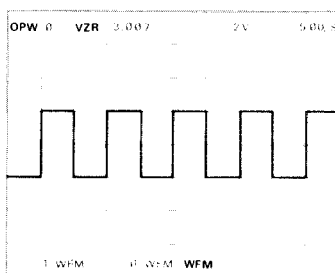

Comments

Display 0 WFM contents.

OBSERVING EFFECTS OF A >P/W (Cont)

Press

Display

Comments

1 **WFM**

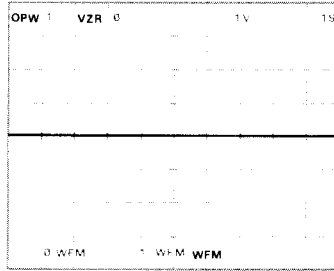

Display 1 WFM contents.

2 **WFM**

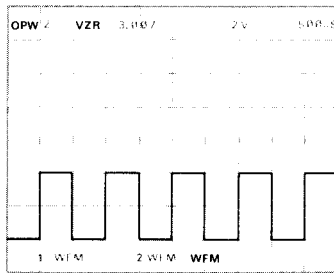

Display 2 WFM contents.

3 **WFM**

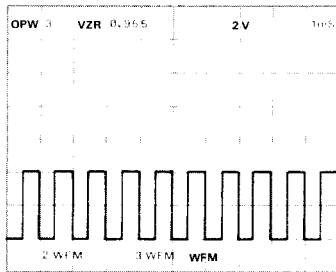

Display 3 WFM contents.

OBSERVING EFFECTS OF A >P/W (Cont)

Now, let's change the P/W value and observe the reorganization of the waveform memories:

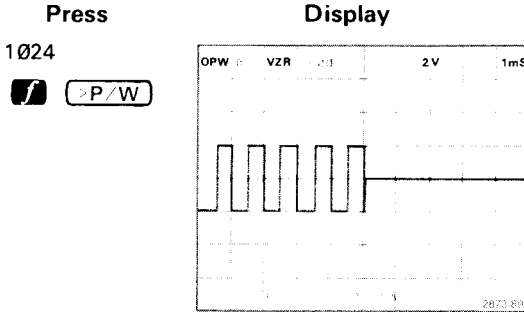

>P/W Restrictions: The X register must contain a constant which (when rounded to an integer) is one of 128, 256, 512, or 1024, prior to execution of the >P/W command. P ERROR is issued if this restriction is violated.

Exercise continues on next page

OBSERVING EFFECTS OF A >P/W (Cont)

To recover the waveforms as they were originally stored:

Press

512

Display

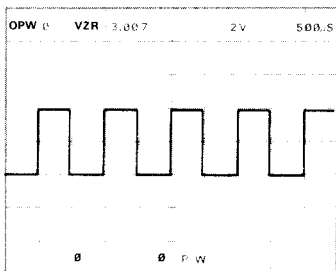

Comments

The calibrator signal stored using 75 **AVG** is displayed as originally stored in 0 WFM. All waveform memories have been restructured.

NOTE

Stored waveform data is recoverable only if the P/W value is returned to the original setting before a command is executed which either changes the value of any waveform point, the stored scale factors, or the vertical zeros.

RECALLING AND SETTING THE VALUE OF A POINT

Each stored point of the operational waveform can be directly accessed.

For example, to recall the vertical value of the 102nd point:

Press

102

Display

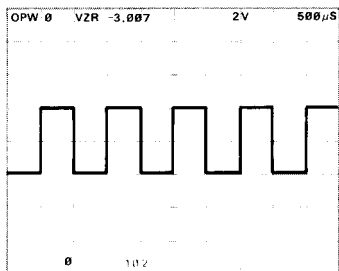

Comments

We have entered the point number of **102** into the X register. This is the point whose vertical value we need.

RECALLING AND SETTING THE VALUE OF A POINT (Cont)

Press

PNT

Display

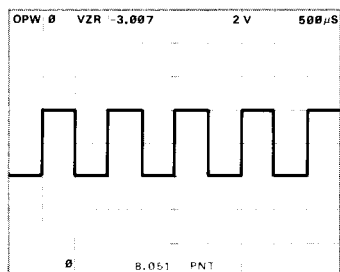

Comments

The vertical value of point 102 is displayed in the X register.

PNT Restriction: The X register must contain a constant which, when rounded to an integer, is from 0 to the maximum waveform point number (inclusive). PNT ERROR is issued if this restriction is violated.

To have the processor return the vertical value of a specific point on a stored waveform:

- Key in the number of the point.
- Press **PNT**.
- Read the vertical value of the designated point from the X register.

Now, let's change the value of a specific point. To change the present setting of point number 102 to the VZR setting of 0 volt:

Press

0 ENTER

Display

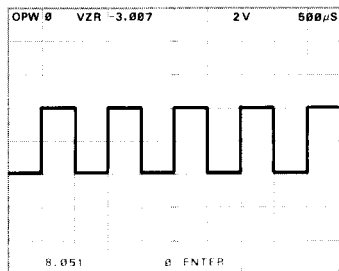

Comments

The vertical value of 0 volts relative to the VZR of the OPW has been entered into the stack.

Exercise continues on next page

COMPUTED WAVEFORM SCALING, OVERFLOW, AND UNDERFLOW

All new waveforms which have been generated by the processor (e.g., with the use of the arithmetic functions) are automatically scaled vertically so that:

1. The vertical scale factor is in the format of $d * 10^n$, where $d = 1, 2, \text{ or } 5$, and $n = \text{integer}$.
2. The VZR is set to a full graticule division within the vertical range limits of $+2\theta$ and -2θ divisions from the center horizontal graticule line.
3. The waveform points are displayed within $+ \text{ or } - 3.5$ divisions from the center horizontal graticule line.
4. First the vertical scale factor and then the VZR are set as small as possible while still consistent with 1 through 3 above.

Whenever a waveform point value (vertical scale factor times the point value, in divisions relative to the VZR) is smaller than the smallest internally representable value of $1 * 2^{-32.767}$, it is set to θ .

If all points of a waveform are θ , the VZR is set to θ , the vertical scale factor is set to 1, and the horizontal scale factor is left unchanged.

If a point value exceeds the largest internally representable value of: $(1 - 2^{-15}) * (2^{32.767})$, it is set to this value and the waveform is scaled to $+ \text{ or } -3$ divisions.

WAVEFORMS AS ARITHMETIC OPERANDS

The arithmetic functions (previously discussed under Mathematical Calculations in this section of the manual) can also be used with waveform(s) as the operand(s). The following exercises demonstrate the effects of these one- and two-operand functions when waveforms replace the numbers as the operands.

A one-operand arithmetic function performed on a waveform results in a new waveform in θ WFM.

A two-operand arithmetic function performed with one waveform and one constant results in a new waveform in θ WFM which is calculated by combining each waveform point value with the constant value. The resulting horizontal scale factor and both scale factor units (e.g., V, S) are retained from the original waveform.

A two-operand arithmetic function performed using two waveforms results in a new waveform in θ WFM which is calculated by applying the specified operation to corresponding points of each operand waveform. In this case, if the horizontal scale factor and horizontal scale factor unit of each operand was the same, the resulting

horizontal scale factor unit will be retained from both operands; however, if they differed, the resulting unit will be left blank, the default scale factor of 1 will be assigned, and a warning¹ will be issued. In addition, the resulting vertical scale factor unit will be blank if the operand units were not identical prior to **[+]** or **[-]** and whenever either **[*]** or **[/]** is performed. Figure D, block 2 shows the location of the keys demonstrated in the following exercises.

OBSERVING WAVEFORMS WITH ONE-OPERAND ARITHMETIC FUNCTIONS

To perform one-operand arithmetic functions (SQRT, LN, EXP, ABS, and SGN) with a waveform as the operand:

- a. Place the waveform memory address into the X register using the WFM command.
- b. Press the desired function key (see the above list).

To demonstrate the one-operand arithmetic functions of SQRT, LN, EXP, ABS, and SGN using a waveform as the operand, first perform steps 1 through 3 of the procedure for Obtaining a Scope Display in Section 4, Scope Display Mode Information.

Set the B HORIZ time-base unit to 20 microseconds/division and triggering to auto mode with ac coupling from the internal source on the negative slope.

Rotate the B INTENSITY control until the trace is at a desirable viewing level (about quarter range).

Connect a triangular shaped waveform (from 0 to +2 V dc) from a function generator (recommended type: TEKTRONIX FG 503 Function Generator used with a TM 500 Power Module) to the input connector of the LEFT VERT amplifier unit with a 42-inch bnc cable. (Match impedances, if necessary.)

Set the deflection factor of the LEFT VERT amplifier unit and the output amplitude of the function generator to display 2 divisions of signal on the crt.

Set the input coupling switch of the LEFT VERT amplifier to ground and position the trace one division below the center horizontal graticule line. Press **[GND]**. Return the input coupling to the dc mode.

Adjust the function generator output frequency for 2.5 cycles of displayed signal.

¹The warning message of XXX WARNING is not displayed for this warning.

OBSERVING WAVEFORMS WITH ONE-OPERAND ARITHMETIC FUNCTIONS (Cont)

Set the B HORIZ time-base unit triggering and position controls for a stable display horizontally centered on the crt.

Set the STORED INTensity control to midrange.

Press

AQR STORED
2  WFM

Display

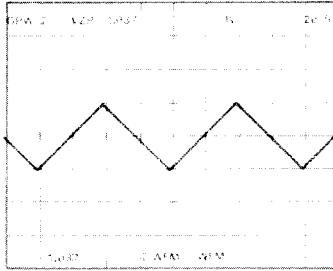

Comments

Acquire and store the signal into 2 WFM for later use.

SQRT

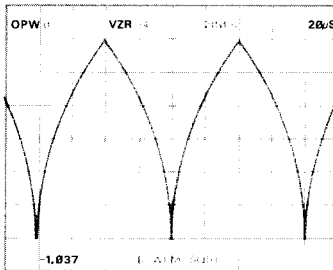

The processor applies the SQRT algorithm to each point of the OPW and places the result in 0 WFM. Notice that the new waveform has been automatically scaled by the processor. (See Computed Waveform Scaling, Underflow, and Overflow for more details.) SQRT WARNING is issued whenever any point of the OPW is negative prior to the SQRT command.

2 WFM

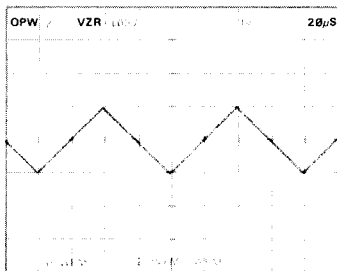

Recall 2 WFM to the display.

OBSERVING WAVEFORMS WITH ONE-OPERAND ARITHMETIC FUNCTIONS (Cont)

Press

LN

Display

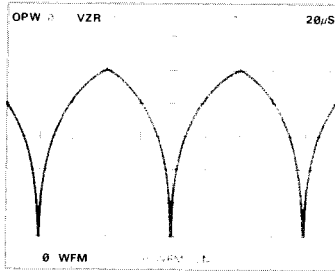

Comments

The natural logarithm of the triangular waveform from 2 WFM is displayed as 0 WFM. LN WARNING is issued if any point of the OPW was 0 or negative prior to the LN command.

2

WFM

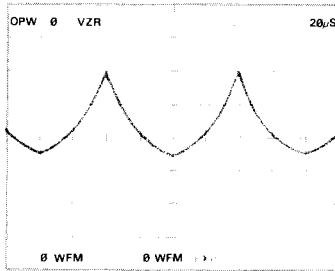

The exponential function of the triangular waveform from 2 WFM is displayed as 0 WFM.

Vertical Position

AQR 3

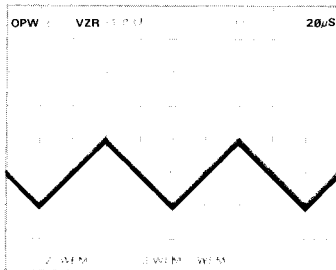

Go to the display mode and position the real-time waveform to be centered about the 0 V dc level (one division below the center horizontal graticule line). Then reacquire the waveform and store it in 3 WFM.

Exercise continues on next page

OBSERVING WAVEFORMS WITH ONE-OPERAND ARITHMETIC FUNCTIONS (Cont)

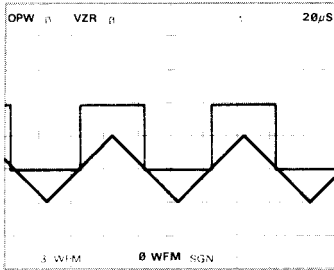
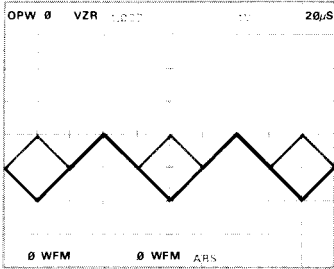
Press	Display	Comments
<p> SGN</p>		<p>The signum function is performed on each point of the triangular waveform from 3 WFM and the result placed in 0 WFM. Where the value of a point was greater than 0 it is set to +1, where equal to 0 it is set to 0, and where less than 0 it is set to -1.</p>
<p>3 WFM ABS</p>		<p>The absolute value of each point of the triangular waveform from 3 WFM is displayed. The resulting waveform is not automatically scaled.</p>

To avoid overflow when computing the LN(x) of a waveform with zero-valued points, use the following sequence:

- Identify the zero-valued waveform points.
- Change the zero-valued points to the smallest non-zero value, which is: $(6E-04) * (\text{Vertical Scale Factor})$.
- Take the LN of the waveform.

For example, to find the LN of 1 WFM:

- Find the zero-valued points by pressing 1 **WFM** 1 **X <> Y** **/** **SGN**.
- Scale this waveform to represent the smallest possible value by pressing 1 **WFM** **VSCL** 6 **EEX** **CHS** 04 ***** 0 **WFM** **CLX**  **=VSCL**.
- Now add this waveform to the original waveform and compute the natural logarithm by pressing 0 **WFM** 1 **WFM** **+** **LN**.

OBSERVING WAVEFORMS WITH TWO-OPERAND ARITHMETIC FUNCTIONS

Two-operand arithmetic functions can be performed upon two constants (as demonstrated under Mathematical Calculations), upon one waveform and one constant, or upon two waveforms.

To demonstrate the use of the arithmetic functions using a constant and a waveform first press **STORED**, then:

Press
2 **WFM**

Display

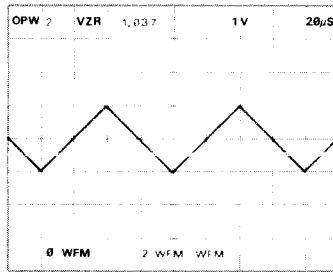

Comments

Recall signal from 2 WFM.

2 *****

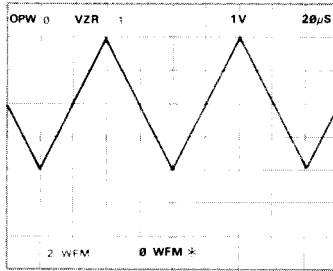

The value of each point of the operational waveform (in relation to the VZR) is multiplied by 2.

To demonstrate this more fully, let's observe what occurs to a specific point when a two-operand arithmetic function is performed using a waveform as one of the operands.

Press
75 **PNT**

Display

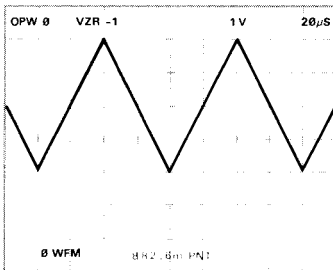

Comments

The value of point 75 of the operational waveform, 882.6m, is displayed in the X register.

OBSERVING WAVEFORMS WITH TWO-OPERAND ARITHMETIC FUNCTIONS (Cont)

Press \emptyset **WFM**

Display

Comments

Enter the waveform operand of \emptyset WFM into the stack.

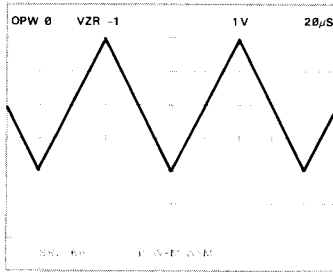

2

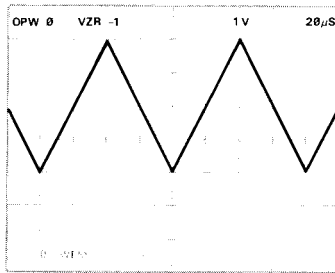

Enter the constant operand of 2 into the stack.

\square

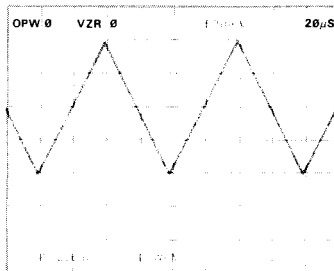

The entire waveform is divided by 2 and rescaled. A warning¹ is issued if any point of the divisor is \emptyset . If the corresponding point of the dividend is also \emptyset , the result is set to \emptyset .

¹The warning message of XXX WARNING is not displayed for this warning.

OBSERVING WAVEFORMS WITH TWO-OPERAND ARITHMETIC FUNCTIONS (Cont)

Press
75 **PNT**

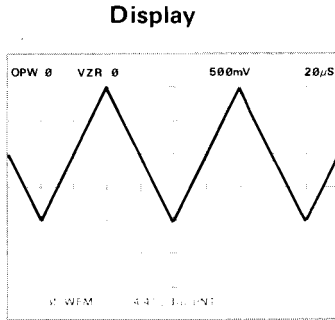

Comments
Notice that the value of this point has been divided by 2.

*A stored waveform can be normalized such that the peak-to-peak value is 1.0 volt by recalling the waveform and pressing **P-P** **0**. Also, the MID point of the waveform can be set to zero volts by recalling the waveform and pressing **MID** **-**.*

Now, let's add two waveforms to illustrate the use of two-operand arithmetic functions when both operands are waveforms:

Press
2 **WFM**
3 **WFM**

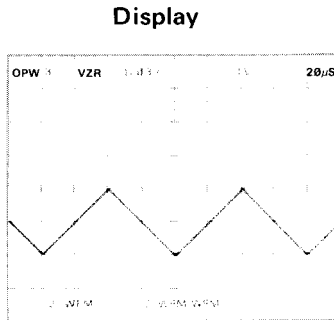

Comments
Enter the two operands of 2 WFM and 3 WFM into the stack.

Exercise continues on next page

OBSERVING WAVEFORMS WITH TWO-OPERAND ARITHMETIC FUNCTIONS (Cont)

Press



Display

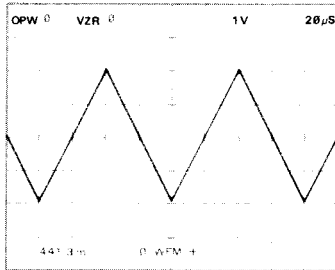

Comments

The two waveforms are added together point by point. The resulting waveform is placed in \emptyset WFM.

NOTE

Refer to Section 9, Command Language, for the algorithms used for each command.

Two repetitive real-time signals which represent current and voltage can be multiplied to determine instantaneous power. With both signals displayed (using ALT or CHOP vertical modes), press **AQR** *****. Be sure that the GND reference has been previously set to the desired value.

NEXT EXERCISE BEGINS WITH POWER-UP

STORED WAVEFORM DISPLAY

The Waveform Calculator adds several commands which allow the operator to set various parameters of the stored waveform display. For example, without the Waveform Calculator the stored waveforms are always displayed as vectors drawn between the points of the waveform (VECT). However, with the Waveform Calculator you can select to display the waveform points only, using the **DOTS** command. Care must be taken when displaying waveforms using the **DOTS** mode to avoid perceptual aliasing or envelope errors. Perceptual aliasing, a type of optical illusion inherent in dot displays, occurs because the human eye tends to connect the dots to their closest neighbors. The closest dots on the display, however, may not be the next points in sequence. This illusion can be avoided by using the vector display mode.

An envelope error occurs when the waveform points do not fall on the peaks of the signal, leaving some of the signal outside the displayed envelope. This problem can occur in either display mode (**DOTS** or **VECT**); but, it can be helped by using more points-per-waveform or a faster sweep speed.

The Waveform Calculator allows up to 9 stored waveforms to be displayed on the crt screen at the same time (using DSW) to aid in waveform comparison, and also allows waveforms to be displayed versus another waveform (**VS**) instead of versus time (**TIME**). The following exercise demonstrates the effects of the **STORED WFM DISPLAY** commands. See Figure D, block 12 for the location of these keys.

DISPLAYING STORED WAVEFORMS AS DOTS OR VECTORS

Perform steps 1 through 3 of the procedure for Obtaining a Scope Display in Section 4, Scope Display Mode Information.

Set the B **HORIZ** time-base unit to 20 microseconds/division and triggering to auto mode with ac coupling from the internal source on the negative slope.

Rotate the B **INTENSITY** control until the trace is at a desirable viewing level (about quarter range).

Connect a triangular shaped waveform from a function generator (recommended type: TEKTRONIX FG 503 Function Generator used with a TM 500 Power Module) to the input connector of the LEFT **VERT** amplifier unit with a 42-inch bnc cable. (If necessary, match impedances.)

Set the deflection factor of the LEFT **VERT** amplifier unit and the output amplitude of the function generator to display two divisions of signal on the crt.

Adjust the function generator output frequency for about four cycles of displayed signal.

Set the B **HORIZ** time-base unit triggering and position controls for a stable display horizontally centered on the crt.

DISPLAYING STORED WAVEFORMS AS DOTS OR VECTORS (Cont)

Using the position control of the LEFT VERT amplifier unit, position the tops of the waveform to one division below the center horizontal graticule line.

Set the STORED INTensity control to quarter range.

Press

128

AQR

Display

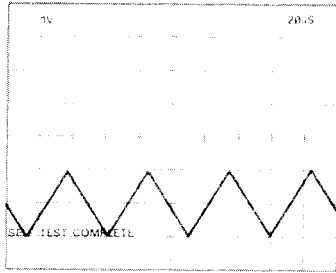

Comments

Set the P/W to 128. (Refer to Table 6-1 for organization of the waveform memories.) Store the waveform.

STORED

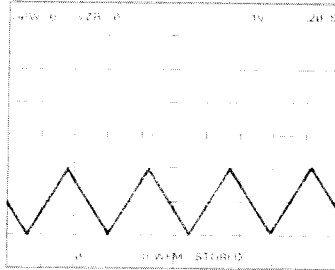

Display the stored waveform. Notice that the waveform is displayed as vectors drawn between the 128 points of the waveform.

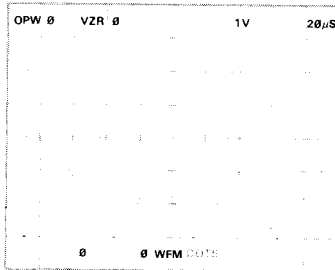

The waveform is displayed as dots only.

DISPLAYING STORED WAVEFORMS AS DOTS OR VECTORS (Cont)

Press

VECT

Display

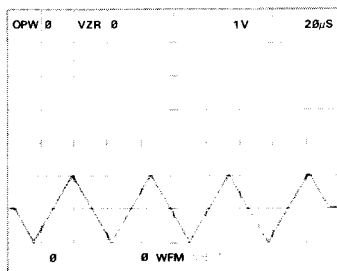

Comments

Return to the vector mode.

DISPLAYING SEVERAL STORED WAVEFORMS

A maximum of 9 stored waveforms can be displayed at the same time on the crt. To demonstrate, first store the following signals:

Press

2 **f** **>WFM**

Display

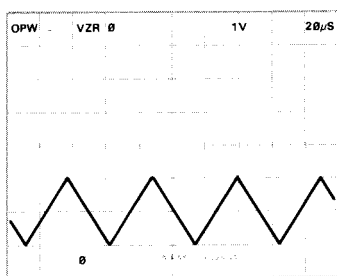

Comments

Copy the triangular waveform into 2 WFM for use in demonstrating the DSW (Display Stored Waveform) command.

Return to the SCOPE mode (by pressing **SCOPE**) and set the function generator to display five cycles of square wave.

Adjust the LEFT VERT amplifier unit to display one division of signal centered around the center horizontal graticule line.

Press

AQR 3 **f** **WFM**

Comments

Store the square wave into 3 WFM.

Exercise continues on next page

DISPLAYING SEVERAL STORED WAVEFORMS (Cont)

Set the function generator to display five cycles of sine wave.

Adjust the LEFT VERT amplifier unit to display two divisions of signal with the base one division above the center horizontal graticule line.

Press

AQR 4 **f** **>WFM**

Comments

Store the sine wave into 4 WFM.

Now, to display all of these signals on the screen at the same time, first return to the STORED display mode:

Press

STORED
1 **DSW**

Display

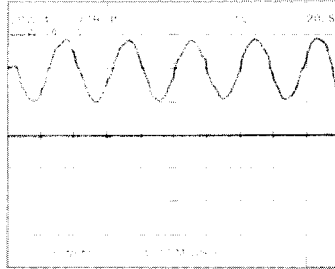

Comments

The sine wave from 4 WFM and the power-up condition of 1 WFM are displayed. The scale factors and VZR are only for the operational waveform (4 WFM). Line 2 of the character display shows 4 and 1 indicating which waveform memories the displayed waveforms are from. The left-to-right sequence of these numbers corresponds to the top-to-bottom sequence of point 0 of each displayed waveform. DSW WARNING is issued if 8 waveforms have already been displayed with the DSW command. (If the operational waveform was not displayed with the DSW command, a total of 9 waveforms may be displayed.)

DISPLAYING SEVERAL STORED WAVEFORMS (Cont)

Press
2 **DSW**

Display

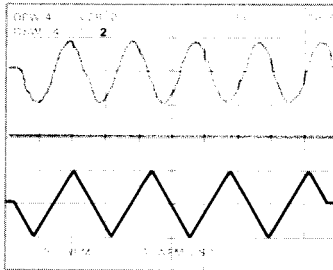

Comments

The triangular waveform from 2 WFM is also displayed. Waveform memory address 2 is added to display line 2.

3 **DSW**

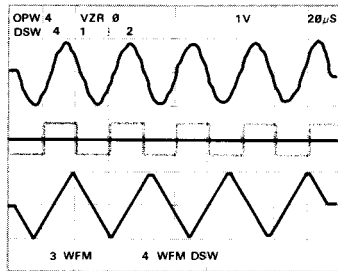

The square wave from 3 WFM is added to the display.

DSW Restrictions: The X register must contain a constant which, when rounded to an integer, is from 0 to the maximum valid waveform memory address (inclusive). DSW ERROR is issued if this restriction is violated.

CLEARING STORED WAVEFORMS FROM THE DISPLAY

To clear a waveform from the display which has been displayed with the DSW command, first enter the waveform memory address number of the waveform to be cleared. For example, to clear 2 WFM from the present display:

Press
2 **CLW**

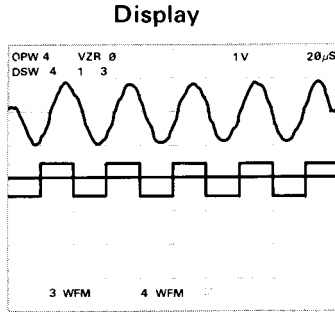

Comments
2 WFM contents are cleared from the display. If necessary, the DSW line of display shifts to reflect the new top-to-bottom sequence of point 0 of the remaining displayed waveforms. CLW WARNING is issued if waveform designated for clearing was not displayed with the DSW.

CLW Restrictions: The X register must contain a constant which (when rounded) is an integer from 0 to the maximum valid waveform memory address (inclusive), prior to executing a CLW command. CLW ERROR is issued if this restriction is violated.

To clear all waveforms from the display, except the operational waveform, which have been displayed with the DSW command:

Press
CLD

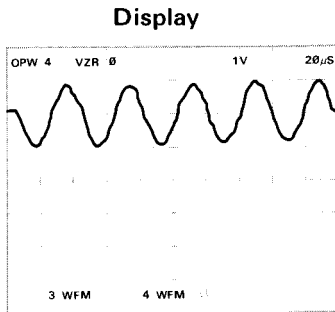



Comments
All waveforms displayed with DSW are cleared from the display (except the operational waveform, even though it too may have been displayed with the DSW command).

DISPLAYING STORED WAVEFORMS IN THE X-Y MODE

Up to nine stored waveforms can be displayed versus another in the X-Y mode.

Use the *command* as follows:

- Display the waveform (with either *WFM* or *DSW* command) which will provide the vertical (*Y-axis*) values for the *X-Y* display.
- Key into the *X* register the waveform memory number of the waveform to provide the horizontal (*X-axis*) values.
- Press  .

Return to Scope Mode. Connect 4-volts of a 50-kHz sine wave from the function generator to the input of the LEFT VERT amplifier unit with a 42-inch bnc cable. (Match impedances, if necessary.)

Set the LEFT VERT amplifier unit and the function generator to display four divisions of signal centered around the center horizontal graticule line.

Set the B HORIZ time-base unit for 2 microseconds/division using the 20 μ s/div and X10 magnification settings. Set the triggering controls for auto mode with ac coupling from the internal source.

Adjust the B INTENSITY if necessary.

Using the B HORIZ position control, display one cycle of the sine wave as shown below:

Press
512  

Display

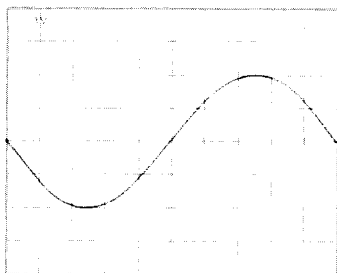

Comments

Return P/W setting to 512 to increase the resolution of stored waveforms. This sine wave will be stored for display later in a Lissajous pattern.

DISPLAYING STORED WAVEFORMS IN THE X-Y MODE (Cont)

Press
 [AVG10]
 [STORED] 3
 [f] >WFM

Display

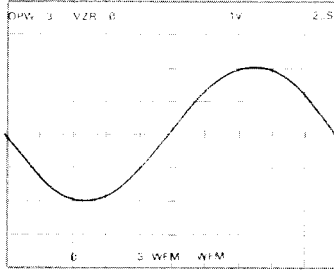

Comments
 Store the sine wave in 3 WFM.

[f] [BOTH]

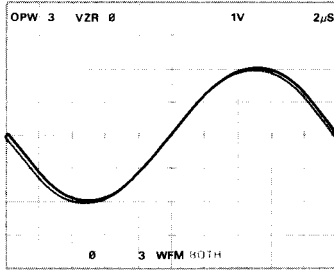

Display both the real-time and the stored sine waves.

Using the B HORIZ time-base unit trigger level control, position the real-time sine wave as shown below:

Display

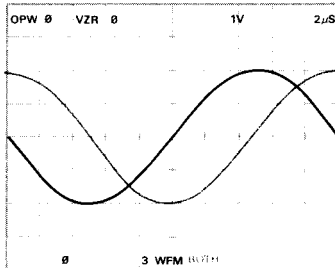

Comments
 Position the sine wave 90° out of phase with the stored sine wave.

DISPLAYING STORED WAVEFORMS IN THE X-Y MODE (Cont)

Press
AVG10
STORED 2
f **>WFM**

Display

Comments

Store the out-of-phase sine wave in 2 WFM.

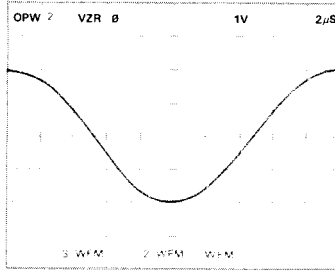

3

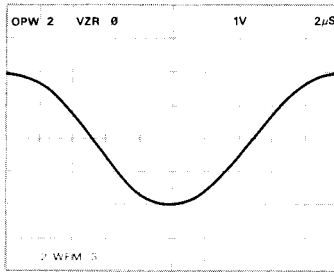

Enter the address number of the waveform memory which is to be the horizontal axis of the display (the versus waveform).

f **VS**

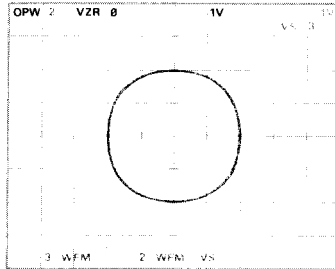

The Lissajous pattern formed by displaying the operational waveform versus 3 WFM is shown. The "horizontal scale factor" is the vertical scale factor of the versus waveform. The waveform memory address number of the versus waveform (which in this case is 3) is displayed at the right end of display line 2, preceded by the mnemonic VS.

Exercise continues on next page

DISPLAYING STORED WAVEFORMS IN THE X-Y MODE (Cont)

Operation: The horizontal position of each displayed waveform point is the vertical value (in divisions, measured from the center horizontal graticule line) of the like-numbered point of the waveform chosen for the horizontal axis.

Restrictions: The X register must contain a constant which, when rounded, is an integer from 0 to the maximum valid waveform memory address number (inclusive), prior to executing a command. VS ERROR is issued if this restriction is violated.

All waveforms displayed following the command (and prior to a TIME command) are displayed versus the designated waveform. To illustrate:

Press
3 **DSW**

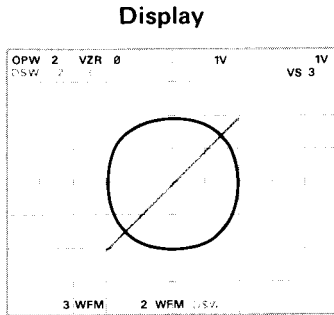

Comments
3 WFM is displayed versus 3 WFM.

DISPLAYING STORED WAVEFORMS IN THE Y-T MODE

To return to using time as the horizontal axis of the display:

Press
TIME

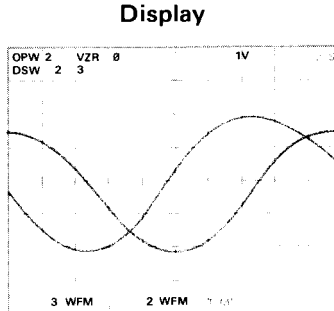

Comments
All displayed waveforms (3 WFM and 2 WFM in this case) are displayed using time as the horizontal axis.

NEXT EXERCISE BEGINS WITH POWER-UP

CURSORS

The cursor commands available on the measurement keyboard are duplicated on the Waveform Calculator keyboard and will not be discussed here in detail; however, the four additional cursor commands included on the Waveform Calculator keyboard will be demonstrated. See Figure D, blocks 7 and 9 for the location of the CURSOR keys used in the following exercises.

POSITIONING THE CURSORS

Perform the exercise entitled Displaying Stored Waveforms in the X-Y Mode, to the point where the following display is shown on the crt graticule:

Display

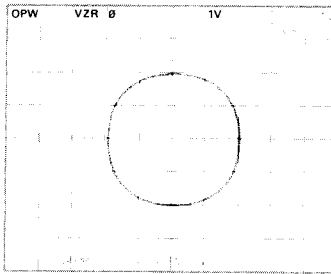

Comments

Lissajous pattern is displayed.

Press

CRS2-1

Display

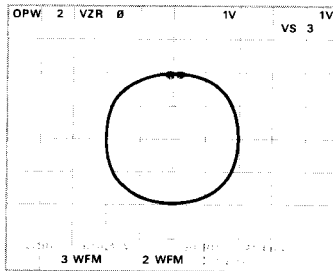

Comments

Both cursors are turned on. Notice that they are positioned at the start and end of the displayed operational waveform. Also notice that the **VCRD** and the **HCRD** readings are given with the same units as those displayed with the corresponding vertical and horizontal scale factors. In this particular case, the unit symbol for both scale factors and both cursor coordinates is **V**.

Exercise continues on next page

POSITIONING THE CURSORS (Cont)

Press

CRS1>

Comments

Notice that Cursor 1 is moved toward the end of the operational waveform, not necessarily to the right.

CRS2<

Cursor 2 moves to the start of the operational waveform.

Press

Display

Comments

The Cursor Positioning Keys As Necessary To Obtain Shown Display

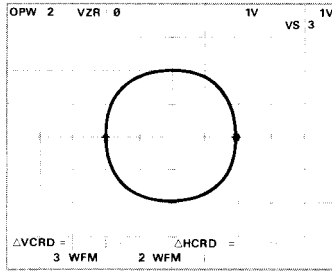

Position cursors to the center horizontal graticule lines.

TIME

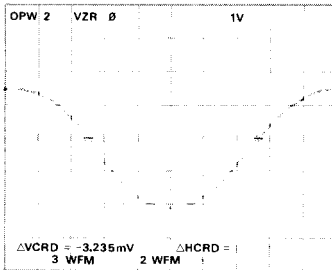

Display the operational waveform versus time. Although the cursors have physically changed their horizontal location on the display, they have maintained the vertical position to which they were set.

POSITIONING THE CURSORS (Cont)

Press



Display

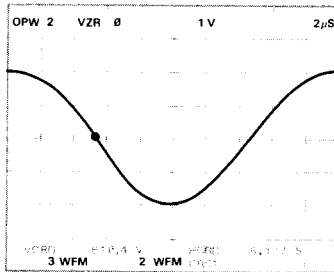

Comments

Turn off Cursor 2.

To move Cursor 1 directly to a point which is a specified time from the start of the waveform:

Press

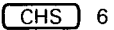

Display

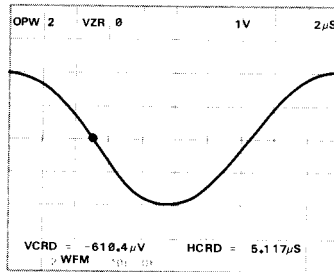

Comments

We have entered the new setting for the HCRD (10 μ s) into the X register.

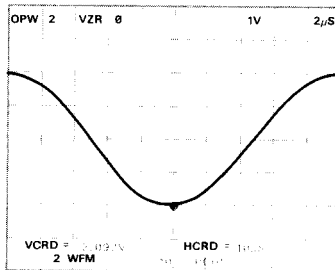
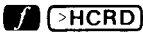

Cursor 1 is moved to the stored point nearest the value in the X register.

Exercise continues on next page

POSITIONING THE CURSORS (Cont)

To set the 2 cursors a specified distance apart:

Press

CRS2-1

Display

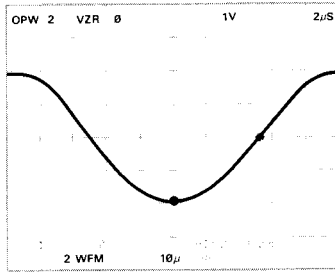

Comments

Turn on both cursors.

6

EEX

CHS

6

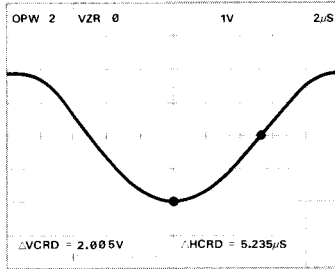

Enter the amount of time to separate the cursors.



>HCRD

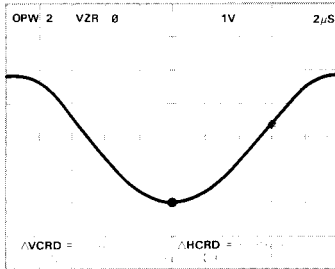



Cursor 2 is moved 6 μ s to the right of Cursor 1. HC WARNING is issued if the number in the X register represents a position beyond the right edge of the graticule for Cursor 2. See >HCRD Operation.

POSITIONING THE CURSORS (Cont)

>HCRD Operation: If the position designated in the X register does not coincide with a stored waveform point, the cursor is set to the nearest stored point. If both cursors are on at the time of a >HCRD command, Cursor 2 is moved so that the difference between Cursor 1 and Cursor 2 is as close as possible to that specified in the X register. However, if this represents a position beyond the right edge of the graticule, Cursor 2 is set to the right edge and HC WARNING is issued.

>HCRD Restrictions: At least one cursor must be turned on, the X register must contain a constant which is greater than 0, and the operational waveform must not have been displayed with the VS command, prior to executing the >HCRD command. HC ERROR is issued if any of these restrictions are violated.

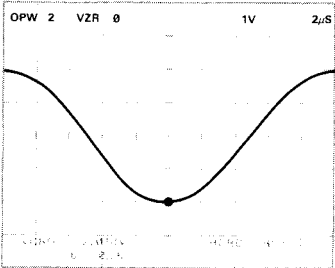
To set the vertical coordinate of Cursor 1 to a specified setting, and thus move the cursor:

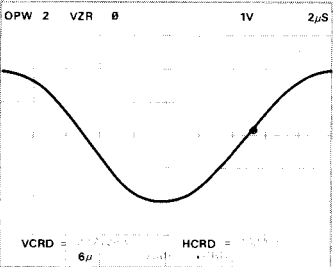
Press	Display	Comments
 CRS1 0.25		Turn off cursor 2 and enter the new setting of the vertical coordinate.
 >VCRD		The vertical coordinate and position of the cursor change to be as close as possible to the specified setting. See >VCRD Operation.

Exercise continues on next page

POSITIONING THE CURSORS (Cont)

To set Cursor 2 a specified vertical distance from Cursor 1:

Press

CRS2-1

Display

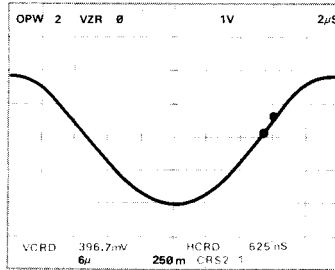

Comments

Turn on both cursors.

1.5

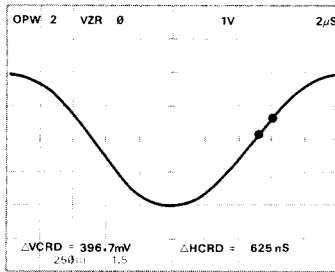

Enter the vertical distance from Cursor 1. See >VCRD Operation.



>VCRD

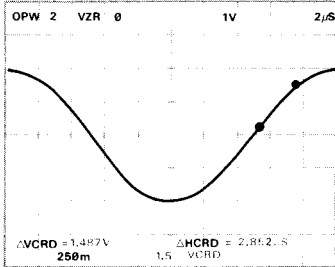

Move Cursor 2 the specified distance from Cursor 1.

POSITIONING THE CURSORS (Cont)

The following keystroke sequence can be used to position the cursors to the 0 PNT and the MAX point for measuring pulse parameters:

- a. Turn on and position Cursor 1 to the MAX point by pressing **f** **CRS1** **MAX** **f** **>VCRD**.
- b. Position Cursor 2 to the same point by pressing **CRS2-1** **0** **f** **>HCRD**.
- c. Reposition Cursor 1 to the 0 PNT by pressing **f** **CRS1** **0** **f** **>HCRD**.
- d. Turn on both cursors **CRS2-1** and make the desired measurement (i.e., DELAY, RISE, etc.)

>VCRD Operation: With only one cursor on (CRS1 mode), the operational waveform is scanned for the specified vertical level from the present cursor location to the end of the waveform. If a crossing or touching point is not found, the scan continues from the start of the waveform to the cursor. The cursor is set to the point prior to the first crossing or touching point found.

With both cursors on (CRS2-1 mode), the operational waveform is scanned from Cursor 2 to the end of the waveform. If a crossing or touching point is not found, the scan then begins again at Cursor 1 and continues toward Cursor 2. Cursor 2 is then set to the point prior to the first crossing or touching point found.

>VCRD Restrictions: The cursor(s) must not be turned off, and the operational waveform must either cross or touch the designated vertical level within the allowed cursor movement range, prior to execution of the >VCRD command. **VC ERROR** is issued if either restriction is violated.

RECALLING CURSOR COORDINATES

To recall the horizontal coordinate (or relative horizontal coordinate if both cursors are on) to the X register:

Press

HCRD

Display

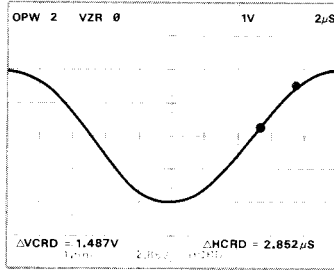

Comments

The displayed horizontal coordinate (or relative horizontal coordinate) is returned to the X register.

HCRD Restriction: At least one cursor must be turned on prior to executing an HCRD command. HCR ERROR is issued if this restriction is violated.

To recall the vertical coordinate (or relative vertical coordinate if both cursors are on) to the X register:

Press

VCRD

Display

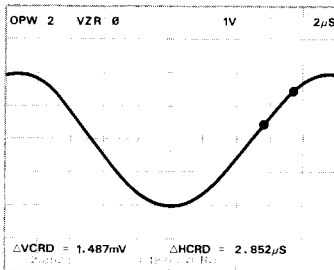

Comments

The displayed vertical coordinate (or relative vertical coordinate) is returned to the X register.

VCRD Restriction: At least one cursor must be turned on prior to executing a VCRD command. VCR ERROR is issued if this restriction is violated.

NEXT EXERCISE BEGINS WITH POWER-UP

WAVEFORM SCALING, EXPANSION, AND POSITIONING

Commands are available with the Waveform Calculator to change the scale factors and vertical zero reference settings of the operational waveform without subsequently affecting the dimensions of the waveform. Also available are commands to vertically or horizontally expand or position the operational waveform. Figure D, blocks 17 and 18 shows the location of the keys demonstrated in the following exercises.

SETTING THE SCALE FACTORS

To change the vertical or horizontal scale factors of the operational waveform:

- a. Key in the new setting for the scale factor.
- b. Press the shift **f** key.
- c. Press **>VSCL** to change the vertical scale factor or **>HSCL** to change the horizontal scale factor.

Perform the procedure for Obtaining a Scope Display in Section 4, Scope Display Mode Information.

Position the CALIBRATOR signal so that the first positive-going pulse starts at the second vertical graticule line, and so the square wave is centered around the center horizontal graticule line.

Set the STORED INTensity control to quarter range.

Press

AQR

STORED

Display

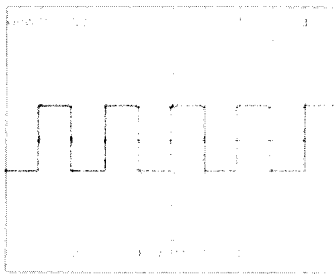

Comments

Display the stored calibrator signal.

Exercise continues on next page

SETTING THE SCALE FACTORS (Cont)

To change the vertical scale factor of the operational waveform to 5 μ V:

Press
5 **EEX**
CHS 6
f **>VSCL**

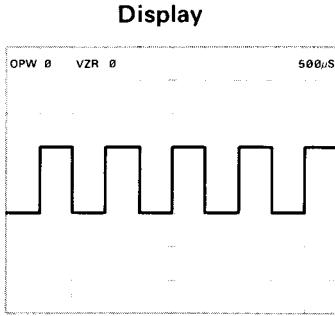

Comments
First enter the new scale factor into the X register, then issue the **>VSCL** command. The vertical scale factor has changed from 100 nV to 5 μ V.

The unit associated with the vertical scale factor, in this case **V**, remains the same.

>VSCL Operation:The operational waveform is displayed with the number in the X register as the vertical scale factor.

>VSCL Restrictions: The X register must contain a constant which is greater than 0 prior to executing the **>VSCL** command. An error message is issued if this restriction is violated.

To change the horizontal scale factor of the operational waveform to 1 ms:

Press
1 **EEX**
CHS 3
f **>HSCL**

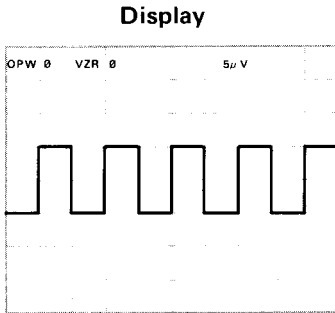

Comments
First enter the new scale factor into the X register, then issue the **>HSCL** command. The horizontal scale factor of the operational waveform has changed to 1 ms. The unit **s** remains the same.

SETTING THE SCALE FACTORS (Cont)

To easily determine the number of a specific point on the stored waveform:

- a. *Change the horizontal scale factor to be equal to the (P/W) divided (1) by pressing $\boxed{P/W}$ 10 $\boxed{/}$ \boxed{f} $\boxed{>HSCL}$.*
- b. *Turn on and position Cursor 1 as desired.*
- c. *The point number where the cursor is located can now be read from the displayed setting.*

If this procedure is used with both cursors on, the setting will reflect the number of points between the cursors.

>HSCL Operation: Executing a >HSCL command is the equivalent to changing the time span of the operational waveform by a value equal to: (the number in the X register) divided by (the original horizontal scale factor). The operational waveform is then displayed with the number in the X register as the horizontal scale factor.

>HSCL Restrictions: The X register must contain a constant which is greater than 0, and the operational waveform must not be displayed with the VS command, prior to executing the >HSCL command. An error message is issued if either restriction is violated.

RECALLING THE SCALE FACTORS

To recall the setting of the operational waveform's vertical scale factor:

Press

VSC

Display

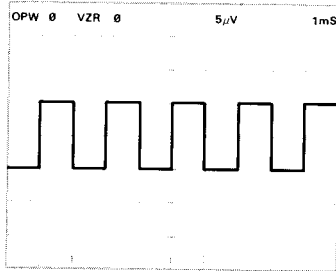

Comments

The vertical scale factor of the OPW is returned to the X register.

To recall the setting of the operational waveform's horizontal scale factor:

Press

HSC

Display

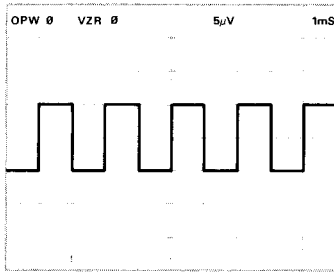

Comments

The horizontal scale factor of the OPW is returned to the X register.

EXPANDING THE STORED WAVEFORM

Vertical Expansion

To vertically expand the operational waveform display, without changing the waveform values:

- a. Key in the expansion rate.
- b. Press **VXPD**.

To vertically expand the operational waveform by a factor of 3:

Press
3 **VXPD**

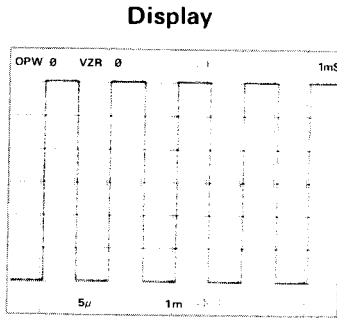

Comments

The operational waveform has been vertically expanded by a factor of 3 times about the center horizontal graticule line. The vertical scale factor is divided by the same factor in order to maintain the waveform values. See VXPD Operation below.

VADERR is issued if the operational waveform is from 0 WFM and the command causes any waveform points to fall outside ± 10 divisions from the center horizontal graticule line. These points are then set to ± 10 divisions.

VXPD Operation: The operational waveform is vertically expanded around the center horizontal graticule line by the expansion factor specified in the X register. If the expansion factor is negative, the waveform is expanded and then inverted. The vertical scale factor is divided by the expansion factor in order to maintain the waveform values.

VXPD Restrictions: The expansion factor must be a constant and must be entered into the X register prior to the VXPD command. If the operational waveform is not from 0 WFM, the expansion must not result in any point falling outside the ± 10 division vertical limits. **VADERR** is issued if either restriction is violated.

EXPANDING THE STORED WAVEFORM (Cont)

Horizontal Expansion

Cursor status affects the operation of the HXPD (Horizontal Expansion) command.

To horizontally expand the operational waveform with both cursors off or with only Cursor 1 on:

- a. Enter the waveform memory address of the operational waveform into the X register by using the WFM command.
- b. Key in the expansion factor. (The OPW number will push into the Y register at this time.)
- c. Press **HXPD**.

To horizontally expand the operational waveform by a factor of 2:

Press

Ø **WFM** 5

Ø **WFM**

Ø **WFM**

Display

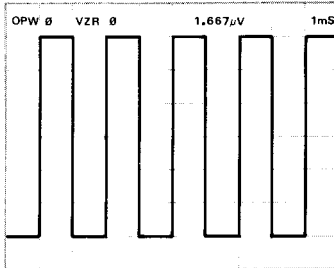

Comments

Enter the number of the operational waveform into the X register after copying the waveform into 5 WFM for storage.

2

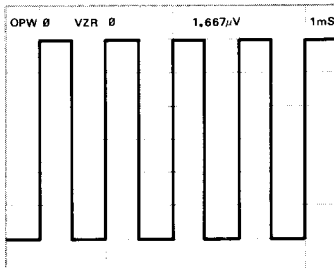

Key in the expansion factor of 2.

EXPANDING THE STORED WAVEFORM (Cont)

Press

HXP

Display

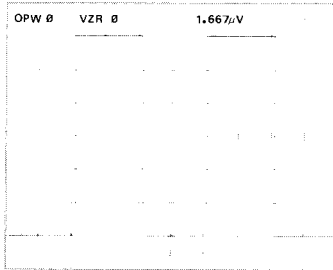

Comments

The operational waveform is horizontally expanded by a factor of 2. Point 0 at the left edge of the graticule remains fixed and the waveform is expanded to the right. Δ is issued if the expansion factor is less than 1, in which case one or more points of the expanded waveform are filled by extending the value of the right-most point of the original waveform.

HXP Operation (Cursors Off): The operational waveform is horizontally expanded about the left edge (point 0) of the graticule by the expansion rate specified in the X register. The horizontal scale factor is divided by the expansion factor in order to maintain the waveform values.

HXP Restrictions (Cursors Off): The Y register must contain the waveform memory address, and the X register must contain a constant greater than 0, prior to executing the HXP command. Δ is issued if either restriction is violated.

To demonstrate the HXP command with Cursor 1 on:

Press



CRS1

CRS1>

Display

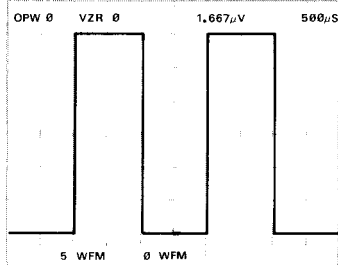

Comments

Turn on Cursor 1 and position it as shown.

Exercise continues on next page

EXPANDING THE STORED WAVEFORM (Cont)

Press

3

Display

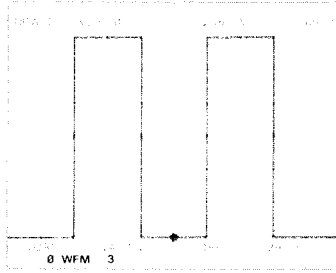

Comments

Enter the expansion factor into the X register. (Notice that the waveform memory address of 0 WFM was already in the X register, therefore we did not need to re-enter it before the expansion factor.)

HXP

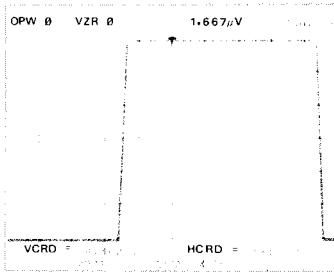

The operational waveform has been horizontally expanded by a factor of 3 times to the right of Cursor 1. HXP WARNING is issued if the expansion factor is less than $\{10 / (\text{the divisions from Cursor 1 to the right edge of the graticule})\}$; meaning that one or more points at the right end of the waveform are filled by extending the right-most point of the original waveform.

HXP Operation (Cursor 1 On): The operational waveform is horizontally expanded about Cursor 1 by the expansion rate specified in the X register. The horizontal scale factor is changed by the expansion factor in order to maintain the waveform horizontal values.

HXP Restrictions (Cursor 1 On): The Y register must contain the operational waveform address and the X register must contain a constant greater than 0, prior to executing the HXP command. HXP ERROR is issued if either restriction is violated.

EXPANDING THE STORED WAVEFORM (Cont)

To horizontally expand the positive-going pulse now displayed with both cursors on:

Press

CRS2-1

CRS1<

CRS2<

Display

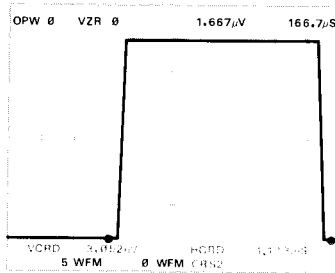

Comments

Turn on Cursor 2 and position the cursors as shown.

HXPDP

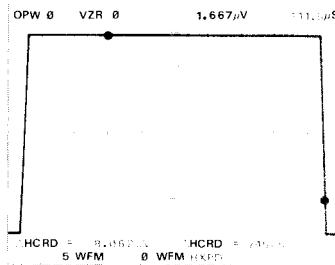

The portion of the operational waveform between the cursors has been expanded to fill the full 10 graticule divisions. The cursors maintain their horizontal positions on the graticule. The horizontal scale factor has been changed to maintain the waveform values.

- To horizontally expand the operational waveform with both cursors on:
- Enter the waveform number of the operational waveform into the stack by using the *WFM* command.
 - Position the cursors to delimit that portion of the operational waveform to be expanded.
 - Press **HXPDP**.

Exercise continues on next page

EXPANDING THE STORED WAVEFORM (Cont)

HXPD Operation (Both Cursors On): That portion of the operational waveform delimited by the cursors is expanded to fill the 10-division graticule. The horizontal scale factor is changed to maintain the waveform values.

HXPD Restriction (Both Cursors On): The X register must contain the waveform memory address of the operational waveform prior to executing the HXPD command. is issued if this restriction is violated.

NEXT EXERCISE BEGINS WITH POWER-UP

POSITIONING THE STORED WAVEFORM

Using commands available on the Waveform Calculator, the operational waveform can be repositioned either vertically or horizontally.

To demonstrate, first perform the procedure for Obtaining a Scope Display in Section 4, Scope Display Mode Information.

Position the CALIBRATOR signal so that the first positive-going pulse starts at the second vertical graticule line, and so the square wave is centered around the center horizontal graticule line.

Set the STORED INTensity control to quarter range.

Vertical Positioning

Since operation of the VPDN (Vertical Position Down) command is similar to that of VPUP (Vertical Position Up), only VPUP will be demonstrated.

Press

AQR

STORED

Display

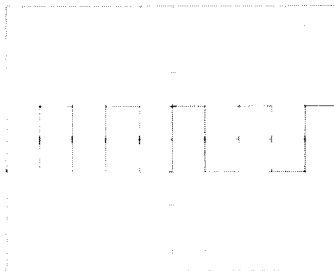

Comments

Display the stored calibrator signal.

POSITIONING THE STORED WAVEFORM (Cont)

To move the operational waveform up:

Press

VPUP

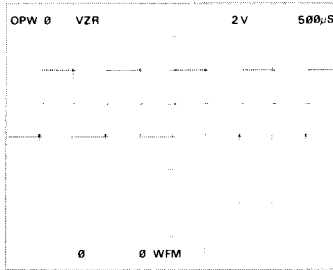
Display**Comments**

The operational waveform moves upward by increments (102.4 increments/division). If the key is depressed longer than approximately 300 milliseconds, the movement of the waveform begins to be continuous, advancing in incremental steps as long as the key is depressed. Notice that the reading changes to reflect the new vertical position of the waveform.

is issued if the operational waveform is from 0 WFM and the move has caused any points to be outside the vertical limit of +20 divisions from the center horizontal graticule line. These points are then set at +20 divisions. The warning is not issued until after the move is made, therefore take care that the waveform is not unnecessarily clipped.

VPUP Restrictions: The vertical zero reference must not exceed +20 divisions; and if the operational waveform is not 0 WFM, all points of the moved waveform must be within +20 divisions of the center horizontal graticule line. is issued if either restriction is violated.

Exercise continues on next page

POSITIONING THE STORED WAVEFORM (Cont)

To manually move the operational waveform down, press **VPDN**. **VPD WARNING** is issued if the operational waveform is from \emptyset WFM and if the move would result in any points falling outside the $-2\emptyset$ division vertical limit. Those points are then set to $-2\emptyset$ divisions from the center horizontal graticule line.

VPDN Restrictions: The vertical zero reference must be higher than, or equal to, $-2\emptyset$ divisions; and if the operational waveform is not \emptyset WFM, all points of the moved waveform must be within $-2\emptyset$ divisions of the center horizontal graticule line. **VPD ERROR** is issued if either restriction is violated.

The operational waveform can also be vertically positioned by directly setting the vertical zero reference (VZR) to a specified value. For example:

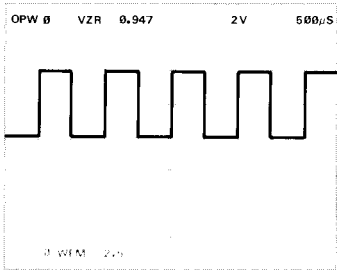
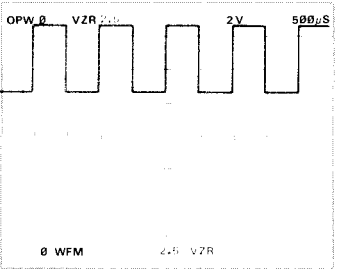
Press	Display	Comments
2.5		Enter the new vertical zero reference (in divisions relative to the center horizontal graticule line).
VPD		The operational waveform has been moved to the new vertical zero reference level of 2.5 divisions above the center horizontal graticule line. VPD WARNING is issued if the operational waveform is \emptyset WFM and the move would cause any points to fall outside the vertical limits of $\pm 2\emptyset$ divisions. Those points are then set to the vertical limits.

POSITIONING THE STORED WAVEFORM (Cont)

VZR Restrictions: The X register must contain a constant from -20 to less than $+20$; and if the operational waveform is not from 0 WFM, all points of the moved waveform must be within ± 20 divisions of the center horizontal graticule line, prior to execution of the \rightarrow VZR command. \rightarrow VZ ERROR is issued if either restriction is violated.

To return the operational waveform to the original display:

Press
 0  **VZR**

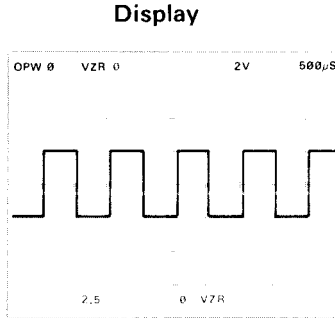

Comments
 Return the operational waveform to the display.

Horizontal Positioning

Cursor status affects the operation of the horizontal position commands.

To demonstrate the horizontal positioning commands (\rightarrow HPLFT and \rightarrow HPRGT), we will first mark the displayed waveform with a reference by moving a point to a higher vertical value. Now, with the cursors off:

Press
 2.5 **ENTER**

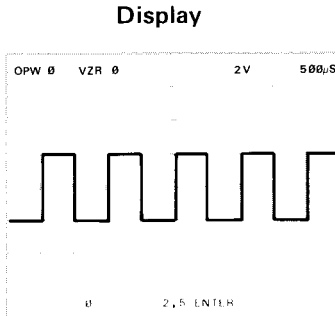

Comments
 Key in the new vertical value of 2.5 volts into the X register.

Exercise continues on next page

POSITIONING THE STORED WAVEFORM (Cont)

Press

206

Display

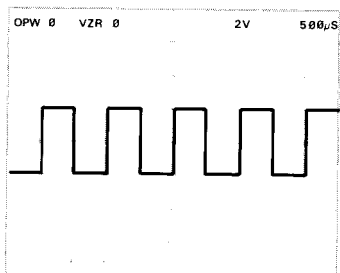

Comments

Key in the point number $\{ [(P/W) / 10] * \}$ (number of divisions to the right of the waveform start where the point is); in this case, 206.

 PNT

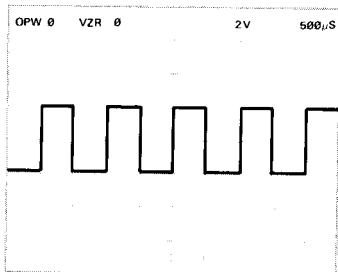

The point is moved to the 2.5 volt level. (Adjust the STORED INTensity, if necessary.)

- To horizontally position the operational waveform with the cursors off:
- Enter the amount of time by which the operational waveform is to be moved.
 - Press the shift  key.
 - Press the **HPRGT** to move the waveform to the right, or press **HPLFT** to move the waveform left.

POSITIONING THE STORED WAVEFORM (Cont)

Now, move the operational waveform to the left by 250 microseconds:

Press

250 **EEX**
CHS 6

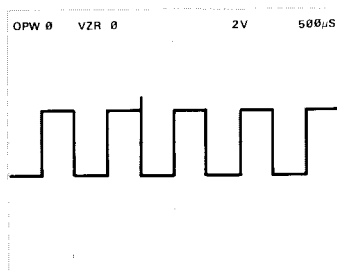
Display**Comments**

Enter the amount of time which the waveform will be moved.

f **HPLFT**

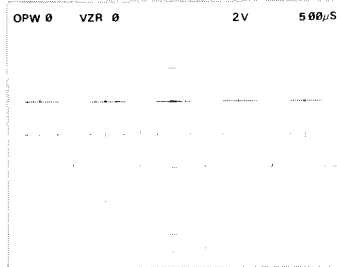

The square wave is moved left 250 μ s (0.5 division).

HPLFT Operation (Cursors Off): The operational waveform is rotated to the left by the amount of time in the X register.

HPLFT Restrictions (Cursors Off): The X register must contain a constant from 0 to the maximum horizontal value of the operational waveform, prior to execution of the HPLFT command. An error message is issued if this restriction is violated.

Exercise continues on next page

POSITIONING THE STORED WAVEFORM (Cont)

To move the operational waveform to the right by 500 microseconds:

Press
 500 **EEX**
CHS 6

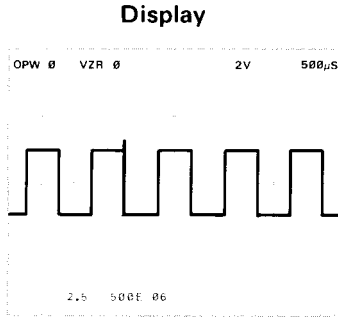

Comments
 Enter the amount of time by which the waveform will be moved (500 µs).

f **HPRGT**

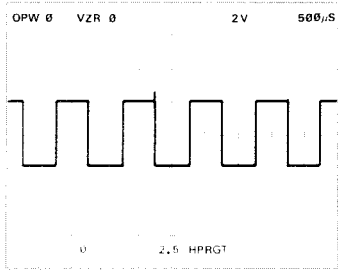

The square wave is moved 500 µs to the right.

HPRGT Operation (Cursors Off): The operational waveform is rotated to the right by the amount of time in the X register.

HPRGT Restrictions (Cursors Off): The X register must contain a constant from 0 to the maximum horizontal value of the operational waveform, prior to execution of the HPRGT command. HPR ERROR is issued if this restriction is violated.

To horizontally position a specific point of the operational waveform to a designated position on the display graticule:

- a. Turn on Cursor 1 and position it to the waveform point of interest.
- b. Key in the time reference on the display graticule { (number of horizontal divisions) * (the horizontal scale factor) } where the waveform point is to be placed.
- c. Press the shift **f** key.
- d. Press the appropriate horizontal position key (either **HLEFT** or **HPRGT**).

POSITIONING THE STORED WAVEFORM (Cont)

To move the marker on the displayed operational waveform to be at the center vertical graticule line:

Press
 **CRS1**
CRS1>

Display

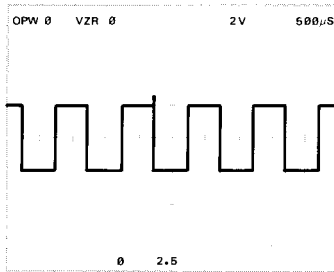

Comments

Turn on and position Cursor 1 to the waveform marker.

2.5 **EEX**
CHS 3

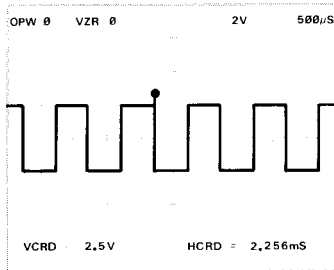

Enter the time reference of (5 divisions * 500 µs) in the X register

 **HPRGT**

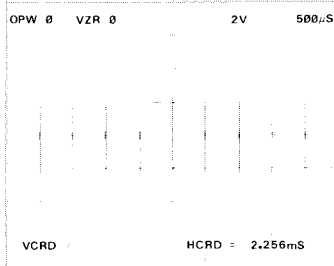

The waveform is rotated to the right by the amount of time necessary to move the marker to the 2.5 ms reference.

Exercise continues on next page

POSITIONING THE STORED WAVEFORM (Cont)

HPRGT Operation (Cursor 1 On): The operational waveform is rotated to the right by the absolute value of the difference between the HCRD setting and the time in the X register.

HPRGT Restrictions (Cursor 1 On): The X register must contain a constant which is from 0 to the maximum horizontal value $\{10 * (\text{horizontal scale factor})\}$ of the operational waveform, prior to execution of the HPRGT command. **NOV ERROR** is issued if this restriction is violated.

To move the marker to the second vertical graticule line, first position Cursor 1 to the top of the marker. Now:

Press	Display	Comments
500 [EEX]		Enter the time reference.
[CHS] 6		

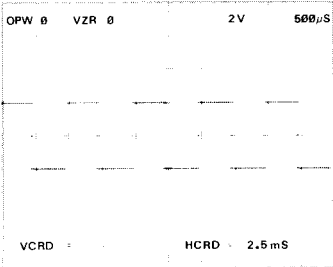

 [HPLFT]		The waveform is rotated left by the amount of time necessary to move the marker to the 500 µs reference.

HPLFT Operation (Cursor 1 On): The operational waveform is rotated to the left by the absolute value of the difference between the HCRD setting and the time in the X register.

HPLFT Restrictions (Cursor 1 On): The X register must contain a constant which is from 0 to the maximum horizontal value $\{10 * (\text{horizontal scale factor})\}$ of the operational waveform, prior to execution of the HPLFT command. **NOV ERROR** is issued if this restriction is violated.

POSITIONING THE STORED WAVEFORM (Cont)

To horizontally move the operational waveform by the time difference between the two cursors (the relative horizontal coordinate):

- Turn on and position both cursors.
- Press the shift  key.
- Press the appropriate horizontal position key (either  or  or **HPRGT**).

To place waveform point 256 of the operational waveform to the 4-volt level:

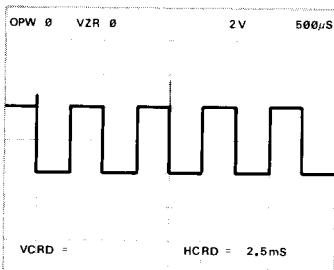
<p>Press</p> <p>4 ENTER 256</p> <p> >PNT</p>	<p>Display</p> 	<p>Comments</p> <p>Move point 256 to the 4-volt level.</p>
---	---	---

To move the operational waveform left by the setting:

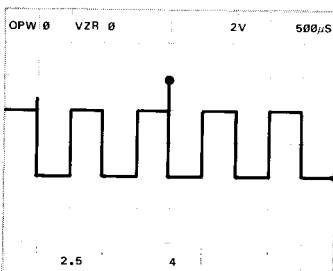
<p>Press</p> <p>CRS2-1</p>	<p>Display</p> 	<p>Comments</p> <p>Turn on Cursor 2.</p>
--	---	---

Exercise continues on next page

POSITIONING THE STORED WAVEFORM (Cont)

Press

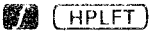

Display

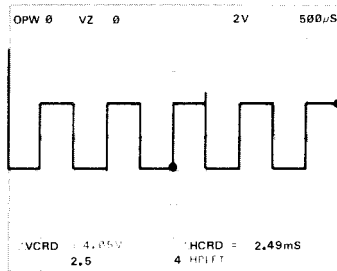

Comments

The waveform is rotated left by 2.49 ms (Δ HCRD value). Notice that this resulted in the shorter marker appearing to move to the right due to the wrap-around operation of HPLFT (and HPRGT); however, it is still 4 divisions (2.49 ms) to the left of the higher marker.

HPLFT Operation (Cursors On): The operational waveform is rotated left by the amount of time between the cursors (the Δ HCRD reading).

To move the waveform to the right:

Press



Display

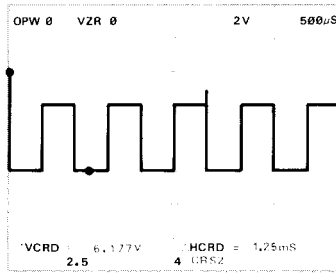

Comments

Position the cursors as shown.

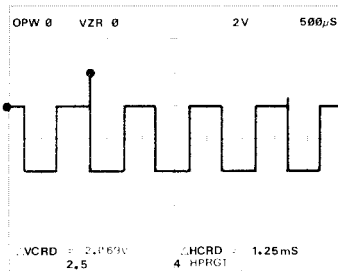
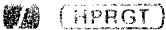

The waveform is rotated right by 1.25 ms (Δ HCRD value).

POSITIONING THE STORED WAVEFORM (Cont)

HPRGT **Operation (Cursors On)**: The operational waveform is rotated right by the amount of time between the cursors (the Δ HCRD reading).

NEXT EXERCISE BEGINS WITH POWER-UP

WAVEFORM FUNCTIONS

All of the commands in the WFM FUNCTIONS block on the Waveform Calculator require the horizontal extent of the operational waveform in order to calculate the new waveform. (This is in contrast to the arithmetic functions which treat each waveform point value as a constant.) The following exercises demonstrate the DIFF (Differentiation), INT (Integration), ORD (Return Ordinate), ORD (Set Ordinate), ITRP (Interpolate), and SMOOTH commands. See Figure D, block 18 for the location of the corresponding keys.

NOTE

The DIFF and INTG functions are not exactly reciprocal in the 7854 due to the specific algorithms used. Each function introduces a small amount of smoothing.

DIFFERENTIATING A WAVEFORM

Perform the procedure for Obtaining a Scope Display in Section 4, Scope Display Mode Information.

Position the CALIBRATOR signal so that the first positive-going pulse starts at the second vertical graticule line, and so the square wave is centered around the center horizontal graticule line.

Set the STORED INTensity control to quarter range.

Press

AVGT0

STORED

Display

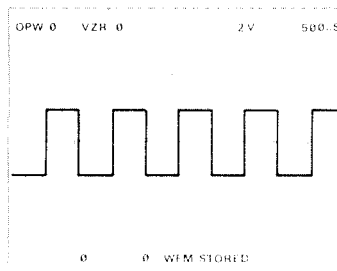

Comments

Store and display the calibrator signal.

DIFFERENTIATING A WAVEFORM (Cont)

Press



Display

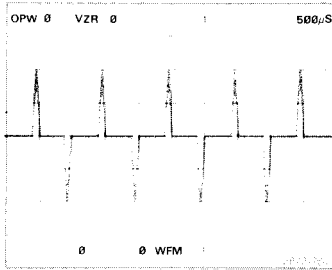

Comments

The square-wave signal has been differentiated. The vertical scale factor is blank. See Section 9, Command Language, for the specific algorithm.

DIFF Restrictions: The X register must contain a valid waveform memory address prior to executing the DIFF command. A message is issued if this restriction is violated.

NOTE

Remember that any dc or constant goes to zero upon differentiation and is not retained automatically.

INTEGRATING A WAVEFORM

To integrate the displayed operational waveform:

Press



Display

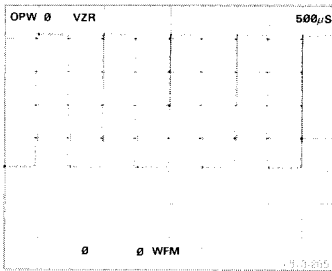

Comments

The waveform has been integrated. The vertical scale factor unit is blank. See Section 9, Command Language, for the specific algorithm.

INTG Restrictions: The X register must contain a valid waveform memory address prior to executing the INTG command. A message is issued if this restriction is violated.

SMOOTHING THE WAVEFORM

Essentially, smoothing replaces each point of the stored waveform with the average value of the waveform within the specified distance about the point.

To smooth a stored waveform:

- Display the waveform to be smoothed (and enter its waveform number into the X register) by using the WFM command.
- Enter the width of the smoothing window (in divisions) to be used for smoothing the waveform into the X register.
- Press **SMOOTH**.

For example, to smooth the displayed waveform with a window of 1.5 divisions:

Press

1.5

SMOOTH

Display

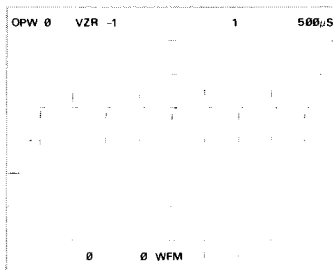

Comments

The operational waveform has been smoothed using a 1.5-division smoothing window. See Section 9, Command Language, for the specific algorithm.

SMOOTH Restrictions: The Y register must contain a valid waveform number and the X register must contain a constant from 0 to 2 (inclusive), prior to execution of the SMOOTH command. An error message is issued if either restriction is violated.

RECALLING AND SETTING AN ORDINATE VALUE

To recall the value of the operational waveform at the horizontal coordinate of 1.5 milliseconds (from the start of the waveform):

Press

1.5 **EEX**
CHS 3

Display

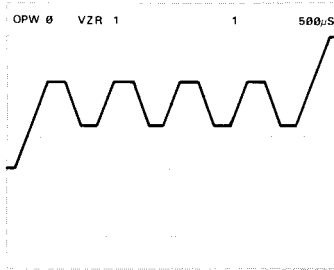

Comments

Enter the horizontal coordinate (from the start of the operational waveform) whose ordinate value is desired.

ORD

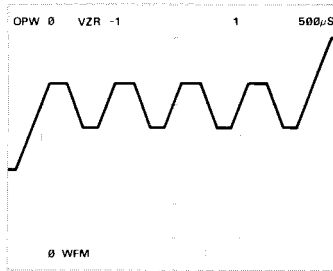

The ordinate value of **1.867** is returned to the X register.

Cursor 1 can be used to change a specific waveform point to a new value:

- Turn on and position Cursor 1 to the point of interest.
- Key in the new point value.
- Recall the *setting to the X register* with **HCRD**.
- Set the point to the new value with **VA** **>ORD**.

RECALLING AND SETTING AN ORDINATE VALUE (Cont)

To set the ordinate value of the operational waveform at 2 milliseconds from the start of the waveform to a value of 3:

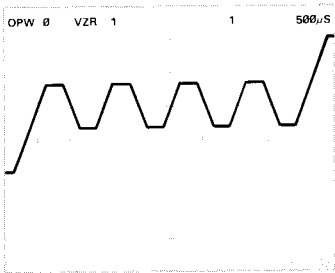
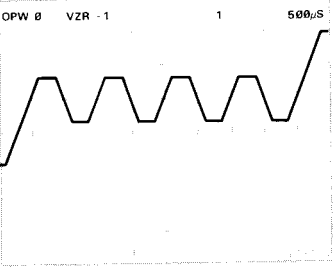
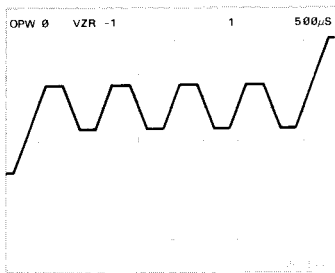
Press	Display	Comments
3 ENTER		Enter the new value, , into the stack.
2 EEX CHS 3		Enter the distance from the start of the operational waveform.
ORD		Set the ordinate value.

Exercise continues on next page

RECALLING AND SETTING AN ORDINATE VALUE (Cont)

Operation: The operational waveform is set to the vertical value given in the Y register at the location given in the X register.

Restrictions: The Y register must contain a constant and the X register must contain a constant from 0 to the maximum horizontal value of the operational waveform (inclusive), prior to execution of the >ORD command. An ERROR is issued if either restriction is violated.

NOTE

The waveform is autoscaled following a >ORD command, if necessary.

INTERPOLATING ON THE WAVEFORM

To interpolate between the second and third vertical graticule lines with the cursors off:

Press

500 [EEX]
[CHS] 6

Display

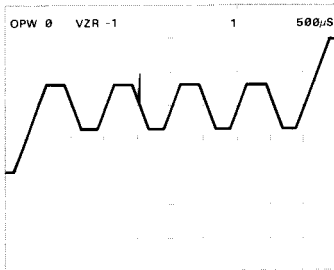

Comments

Enter the horizontal location {(graticule divisions) * (horizontal scale factor)} of 500 µs into the stack.

[ENTER]
1 [EEX]
[CHS] 3

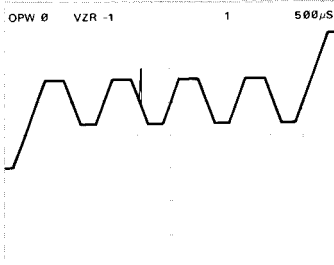

Separate the locations and enter the second horizontal location.

INTERPOLATING ON THE WAVEFORM (Cont)

Press

ITRP

Display

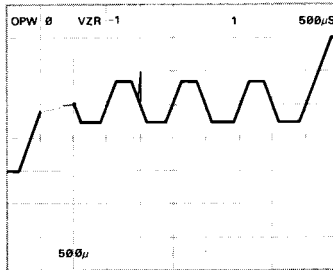

Comments

Interpolate between
500 μ s and 1 ms of the
operational waveform.

To draw a straight line (linearly interpolate) between two specified points on the operational waveform with the cursors off:

- a. Key one of the horizontal locations into the stack.
- b. Press **ENTER** to terminate entry of the first location.
- c. Key the second horizontal location into the stack.
- d. Press **ITRP**.

ITRP Operation (Cursors Off): The portion of operational waveform delimited by the horizontal locations specified in the Y and X registers is replaced with a straight line.

ITRP Restrictions (Cursors Off): The Y and X registers must both contain constants from 0 to the maximum horizontal value of the operational waveform (inclusive), prior to execution of the ITRP command. An error message is issued if either restriction is violated.

Exercise continues on next page

INTERPOLATING ON THE WAVEFORM (Cont)

To interpolate from the start of the second positive-going pulse to the top of the glitch:

Press



CRS1

CRS1>

Display

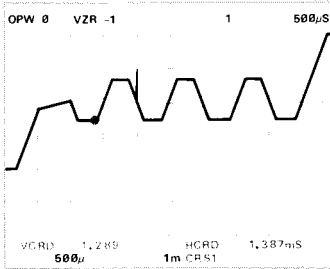

Comments

Turn on Cursor 1 and position it to the start of the second positive-going pulse.

HCRD

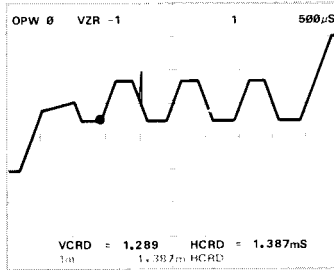

Return the horizontal coordinate value (the horizontal location of the desired starting point for interpolation) into the X register.

CRS1>

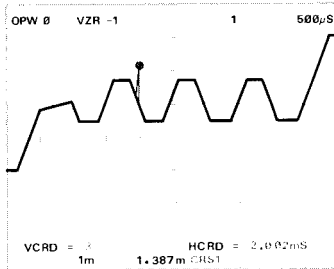

Position Cursor 1 to the top of the glitch, the end point for interpolation.

INTERPOLATING ON THE WAVEFORM (Cont)

Press

ITRP

Display

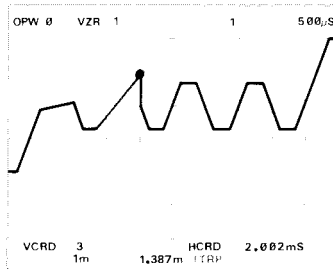

Comments

The designated portion of the operational waveform is replaced with a straight line.

To interpolate with only Cursor 1 on:

- Enter the starting point horizontal location into the X register.
- Position Cursor 1 to the end point of the portion to be interpolated.
- Press **ITRP**.

ITRP Operation (Cursor 1 On): The portion of operational waveform delimited by Cursor 1 and the horizontal location specified in the X register is replaced with a straight line.

ITRP Restrictions (Cursor 1 On): The X register must contain a constant from 0 to the maximum horizontal value of the operational waveform (inclusive), prior to execution of the ITRP command. ITR ERROR is issued if this restriction is violated.

To interpolate from the center vertical graticule line to the present position of Cursor 1:

Press

WFM

Display

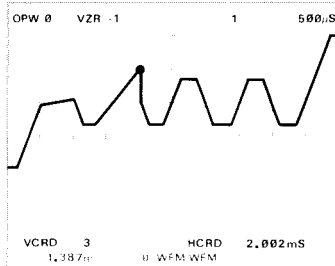

Comments

Display 0 WFM.

INTERPOLATING ON THE WAVEFORM (Cont)

Press

CRS2-1

CRS2<

Display

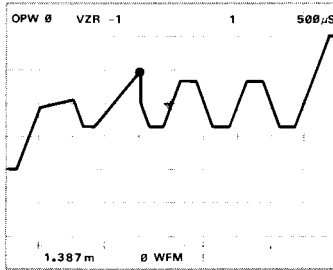

Comments

Turn on and position Cursor 2 as shown.

ITRP

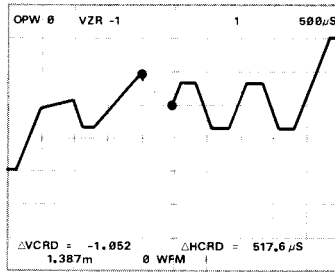

Interpolate between the cursors.

To interpolate with both cursors on:

- a. Display the operational waveform using the *WFM* command.
- b. Position the cursors at the end points of the portion to be interpolated.
- c. Press **ITRP**.

ITRP Operation (Cursors On): The portion of the operational waveform delimited by the cursors is replaced with a straight line.

ITRP Restriction (Cursors On): The X register must contain a valid waveform number prior to execution of the ITRP command. **ERR0** is issued if this restriction is violated.

INTERPOLATING ON THE WAVEFORM (Cont)

This procedure is helpful when you want to generate a linear section of waveform between two specific vertical values:

- a. Turn on and position Cursor 1 to the desired starting point of the linear section.
- b. Set the starting point to the desired vertical level.
- c. Move Cursor 1 to the ending point and set this to the desired vertical level.
- d. Interpolate between these points.

For example, to generate a linear section from the second vertical graticule line to the sixth, from 2 volts to -0.5 volt:

- a. Press **f** **CRSI** and move the cursor to the second vertical graticule line.
- b. Set this point to the 2-volt level by pressing 2 **HCRD** **f** **>ORD**.
- c. Move Cursor 1 to the sixth (center) vertical graticule line and set this point to the -0.5 volt level by pressing .5 **CHS** **HCRD** **f** **>ORD**.
- d. Press **CLX** to move the HCRD of the starting point to the X register. Then interpolate by pressing **ITRP**.

You may at times find it useful to manually generate known waveforms. The following three examples may be helpful.

To generate a ramp which is symmetrical around the crt center; press 0 **WFM** 0 ***** 1 **+** **INTG** **MID** **-**. (Cursors must be off.)

To generate two cycles of a triangular waveform from the generated ramp: Press **ABS** **MID** **-** **ABS** **MID** **□**.

Now, to generate one cycle of sine wave, which will be accurate within 1% at 512 P/W: First generate the two cycles of triangular shape. Now press: **OFF** 2 **SMOOTH** 2 **SMOOTH** 2 **SMOOTH** **HSCl** 2.5 ***** **f** **HPLF1** 2 **HXPd** **HSCl** 2.5 ***** **f** **HPLFT**.

NEXT EXERCISE BEGINS WITH POWER-UP

PROGRAMMING

A 7854 program is a series of commands stored by the processor for later execution. The program can then be run as often as necessary. The results obtained at the end of program execution are identical to those you would have received by manually pressing the keys one at a time.

NOTE

Programs can be written into the program memory either from the Waveform Calculator keyboard or from the GPIB. Only programming with the Waveform Calculator keyboard is discussed here; see Section 7, GPIB Information, for details concerning 7854 programming over the GPIB.

PROGRAM MEMORY

The commands that make up the program are stored by the processor in the program memory. The program memory is separate from the stack, constant registers, and waveform memories; but the processor may utilize any or all of these storage devices during program execution.

Stored programs are organized by program lines which consist of a three-digit processor-assigned line number and a mnemonic-oriented command group. Program lines are sequentially numbered from 000 to a maximum of 999. Each program line must contain at least one command (in addition to the line number), and may contain more. A representative program line could be:



Notice that the keystroke commands are stored and displayed as the corresponding mnemonics, and that spaces automatically separate adjacent mnemonics. To conserve space, the blanks between adjacent numeric commands (0-9, ., EEX, and embedded CHS commands) are suppressed.

The total number of commands that may be entered on one program line is limited to 35 characters, which includes the separating spaces between mnemonics. If a command is issued during program entry which would cause the command group to exceed the limit of 35 characters, a warning¹ is issued and a new program line is started. The last command issued (which exceeded the allowable line length) then becomes the first command on the new line.

¹The warning message of

is not displayed for this warning.

Program memory will hold a maximum of 920 (commands plus line numbers), 2000 with Option 2D ¹, and a maximum of 1000 program lines. If the program memory is full and you attempt to enter an additional command: (1) The ERROR indicators will light; (2) the audible warning tone will be issued if the AUDIBLE ERROR/WARNING switch is ON; (3) the display will blink; and (4) commands other than CLL (Clear Line), CLP (Clear Program), or EXECUTE, will not be accepted.

PROGRAM MODES

Three program modes are provided with the Waveform Calculator: (1) The Entry mode in which commands are not executed but are instead stored in program memory for later execution; (2) the Edit mode which allows the deletion and rearrangement of entire lines of programmed commands; and (3) the Execute mode which allows the processor to automatically execute the programmed commands.

THE ENTRY AND EDIT DISPLAYS

The edit prompt, `>`, indicates where the program can be currently accessed for entry or editing and is displayed at the start of the program line printed on crt display line 8. This program line (which is preceded by the edit prompt) is called the current program line when entering or editing a program. The end-of-program line is the blank line following the last assigned program line.

The Entry and Edit modes override the CRT DISPLAY commands to display up to 16 lines of program. The current program line is printed on display line 8 with the previous seven program lines displayed above this, and the subsequent eight program lines displayed below. Program lines are assigned line numbers after an entered line is terminated. A typical program display is shown in Figure 6-2.

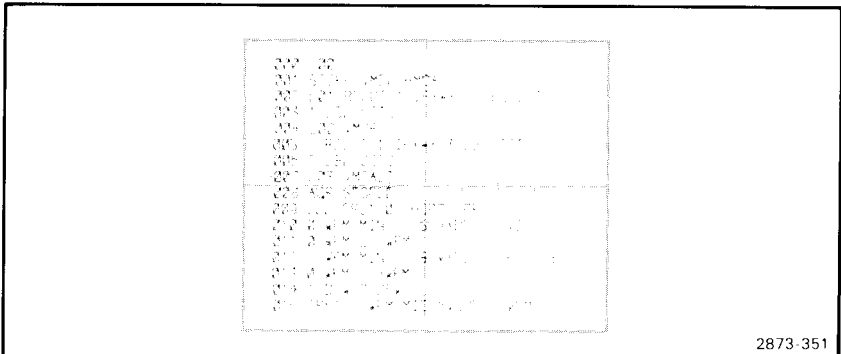

Figure 6-2. A typical program display on the 7854 Oscilloscope.

¹ Applies only to instruments with serial numbers below B085121. For instruments with serial number B085121 and above, features previously provided by Option 2D are standard.

THE ENTRY MODE

The program Entry mode is invoked by the first programmable command received by the processor following either the PROG (Program Entry) command or an edit command. If a program is not already stored, only the edit prompt and the mnemonic of the last received command will be displayed (see Fig. 6-3); otherwise, a one-line space is opened in the program prior to the current program line, and the edit prompt and newly entered command mnemonic are displayed at the start of this new program line (see Fig. 6-4). Any additional programmable commands issued are sequentially added to the command group of the current program line. The Entry mode can be identified by the absence of a line number before the command group of the displayed current program line. To leave the Entry mode simply issue any of the program edit commands or the EXECUTE command.

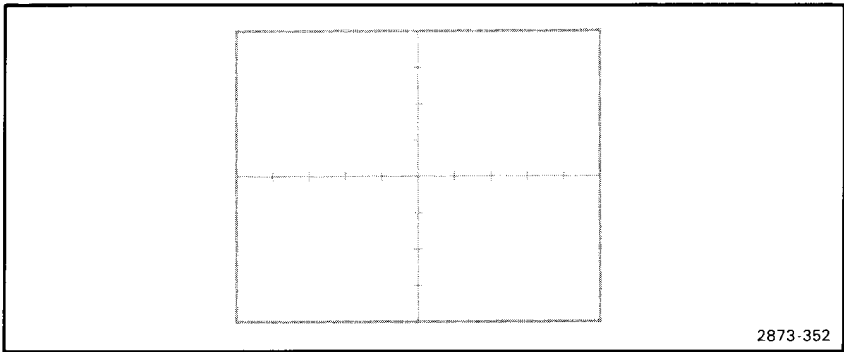

Figure 6-3. Example of the program Entry mode without previously stored programs.

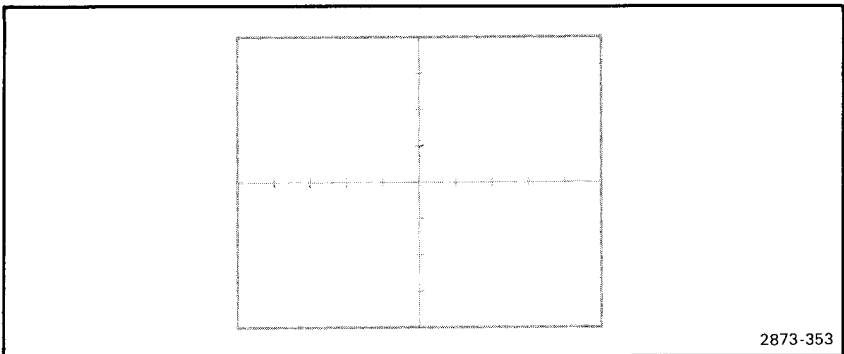

Figure 6-4. Example of the program Entry mode with a previously stored program.

THE EDIT MODE

The program Edit mode is invoked by issuing CLL (Clear Line), CLR (Clear Program), PREV (Go to Previous Line) or NEXT (Go to Next Line) when in the Entry mode; or by issuing the PROG command when in the Execute mode if a program is already stored. The Edit mode (see Fig. 6-5) is distinguishable from the Entry mode by the line number between the displayed edit prompt and the command group of the current program line. The Edit mode is exited by issuing the EXECUTE command or by invoking the Enter mode.

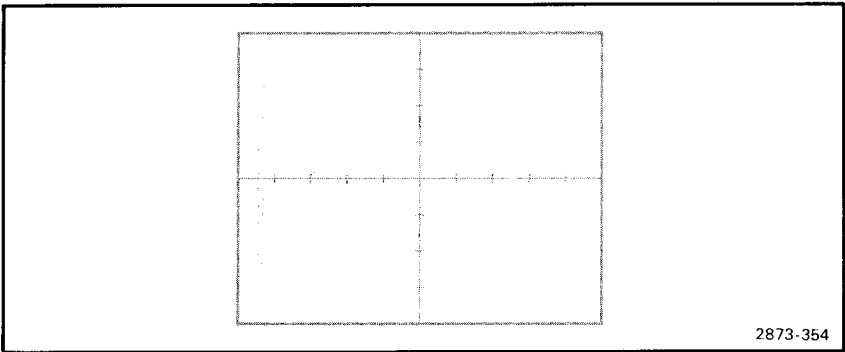

Figure 6-5. Example of the program Edit mode.

THE EXECUTE MODE

The Execute mode is invoked, only after a program has been stored in the program memory, by issuing either RUN, , or STEP following the EXECUTE command. The Execute mode is made up of two distinct states: (1) The Run state which is entered by executing the RUN or command, and (2) the Step state which is entered by executing the STEP command. Before invoking either state of the Execute mode (and after leaving the Enter or Edit mode with the EXECUTE command) the processor is in the "idle" state. While in the idle state, the processor will only execute directly issued commands from the keyboards or the GPIB.

STOP is the only directly issued command which will be accepted during the Run or the Step state; all other directly issued commands are ignored. The 7854 returns to the idle state after executing a stored STOP command or by a directly issued STOP. An error, or a warning occurring in the Step state, will also return the processor to idle.

AN INTRODUCTORY PROGRAM

The exercises given here are intended to acquaint you with the program entry display and will not go into the details of command operation.

This introductory program will average a real-time signal 75 times, store the averaged waveform in 3 WFM, measure the peak-to-peak amplitude of the waveform and place this amplitude in constant register 1 (1 CNS). Then a window from +10% to -10% of the peak-to-peak amplitude is computed; the 110% amplitude value is stored in 2 CNS and the 90% value in 3 CNS. The input signal is then averaged again and the present peak-to-peak amplitude is compared with the 110% and 90% limits.

To do this manually you would first set up the desired real-time display and then issue the following commands:

75 **AVG** 3  **WFM**

Average and store the selected waveform in 3 WFM.

P-P 1  **CNS**

Measure the P-P amplitude and store in 1 CNS.

1 **CNS** 1.1 ***** 2  **CNS**

Compute 110% value and store in 2 CNS.

1 **CNS** 0.9 ***** 3  **CNS**

Compute 90% value and store in 3 CNS.

AVG10 **P-P** 4  **CNS**

Average the input signal (only 10 times, for speed) and place the P-P value in 4 CNS.

2 **CNS** **IFY>X**

Compare if the present P-P value is greater than the 110% limit value.

3 **CNS** 4 **CNS** **IFY>X**

Compare if the 90% limit is greater than the present P-P value.

Now, let's enter the introductory program into program memory.

ENTERING THE PROGRAM

Perform steps 1 through 5 of the procedure for Obtaining a Scope Display given in Section 4, Scope Display Mode Information.

Press

PROG

Display



Comments

The program Entry mode is invoked. The edit prompt is displayed at the start of display line 8.

LNN 0 1

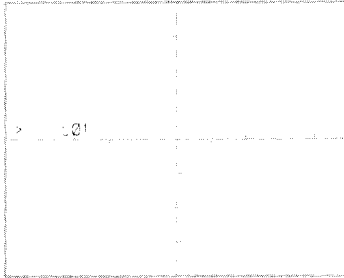

The start of this program is identified with a label (L01). Notice that the mnemonic was only displayed until the shift function was issued.

NOTE

All new commands used in this exercise will be discussed in detail later in this section.

NEXT

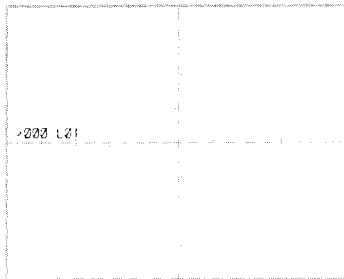

The edit prompt is advanced to the next program line. Notice that the line number (000) has been added to the previous program line.

Exercise continues on next page

ENTERING THE PROGRAM (Cont)



Press	Display	Comments
SCOPE		<p>The mnemonics of the issued commands are entered into the command group of the current program line. Spaces separate adjacent commands (except adjacent numeric commands). This command group will initialize the real-time display.</p>
Vertical Mode:	LEFT	
Horizontal Mode:	B	

NOTE

*Notice that the mnemonics **VMOD** and **HMOD** are displayed to indicate the selected vertical and horizontal modes. (All settings of the **VERTICAL** and **HORIZONTAL MODE** switches are programmable; see the Glossary in section 1 for mnemonics.)*



OFF		<p>Initialize the cursors by assuring that they are turned off. The NEXT terminates the line and advances the edit prompt.</p>
NEXT		

ENTERING THE PROGRAM (Cont)

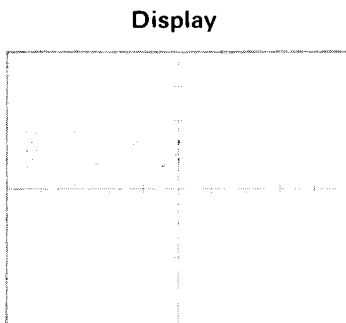
Press
 75 **AVG** 3
 
NEXT



Comments
 Enter the commands to average and store the waveform. Notice that the space between the and is suppressed.

P-P 1
 
 1 **CNS** 1.1
***** 2
 
 1 **CNS**

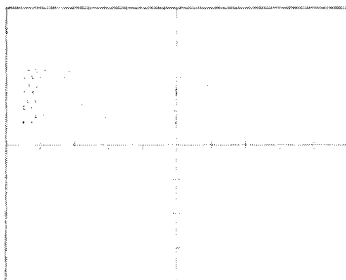

Attempt to enter the remaining commands of the program. Although this is a more efficient use of the program memory, this will make editing a program more difficult and is done here to demonstrate the automatic NEXT which occurs when the line length of 35 characters is exceeded. Notice that the processor terminated the full program line, advanced the edit prompt, placed the offending command in the new current program line, and issued a warning¹.

Exercise continues on next page

¹The warning message of  is not displayed for this warning.

ENTERING THE PROGRAM (Cont)

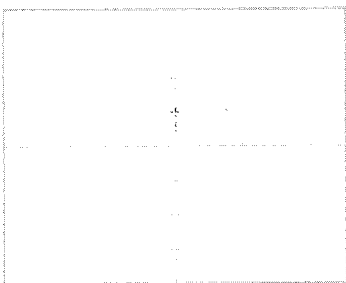
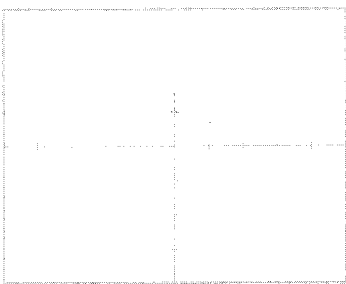
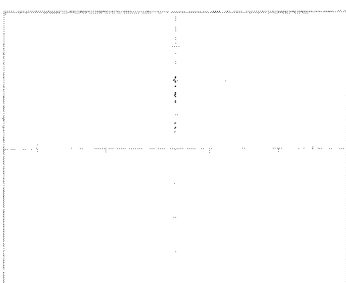
Press	Display	Comments
0.9 $\frac{f}{*}$ 3 $\frac{f}{}$ >CNS NEXT		Enter the commands to compute and store the 90% limit.
$\frac{f}{}$ LNN 0 2 AVG10 P-P 4 $\frac{f}{}$ >CNS NEXT		Enter the commands to average the input signal and store the P-P value in 4 CNS. The label () will be used as the start of the loop.
2 CNS IF Y > X STOP NEXT		Compare the present P-P value to the 110% limit. If the P-P value is greater the program will stop.

ENTERING THE PROGRAM (Cont)

Press	Display	Comments
3 CNS	<pre> 001 SCOPE WMDI HMRZ OFF 002 ZL AVG 2 >WFM 003 P P 1 >CNS 1 CNS 1.1 * 2 <CNS 1 004 CNS 0.3 * 3 >CNS 005 L02 AVG10 P P 4 >CNS 006 2 CNS IFYX STOP 007 3 CNS 4 CNS IFYX STOP 008 0 LBL 0010 </pre>	<p>Compare the 90% limit to the P-P. If the P-P value is less the program will stop. Notice that line 000 is no longer displayed, although it is retained in program memory.</p>
4 CNS		
IFV>X		
STOP		
NEXT		

2 LBI	<pre> 002 ZL AVG 2 >WFM 003 P P 1 >CNS 1 CNS 1.1 * 2 <CNS 1 004 CNS 0.3 * 3 >CNS 005 L02 AVG10 P P 4 >CNS 006 2 CNS IFYX STOP 007 3 CNS 4 CNS IFYX STOP 008 0 LBL 0010 </pre>	<p>If the present P-P value is within the monitoring limits, the program will return to label L02 and continue executing commands from there.</p>
GOTO		
NEXT		
STOP		

STOP	<pre> 002 ZL AVG 2 >WFM 003 P P 1 >CNS 1 CNS 1.1 * 2 <CNS 1 004 CNS 0.3 * 3 >CNS 005 L02 AVG10 P P 4 >CNS 006 2 CNS IFYX STOP 007 3 CNS 4 CNS IFYX STOP 008 0 LBL 0010 </pre>	<p>The end of this program is identified with a STOP.</p>
-------------	--	---

The introductory program is now stored in the 7854 program memory and can be executed at any time.

EXECUTING THE PROGRAM

To execute the introductory program now stored in the 7854, first invoke the idle state by pressing **EXECUTE**. The processor now returns display control to the previously selected CRT DISPLAY mode (SCOPE).

NOTE

*The PROG and EXECUTE functions are issued with alternating actuations of the **PROGRAM ENTRY/EXECUTE** key.*

Now connect an 8-volt (peak-to-peak), 1-kHz sine wave to the input of the LEFT VERT amplifier unit from a function generator. (Recommended type: TEKTRONIX FG 503 Function Generator used with a TM 500 Power Module.)

Set the LEFT VERT amplifier unit to display about 4 divisions of signal centered around the center horizontal graticule line.

To execute the program from the first command of line 000:

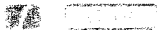
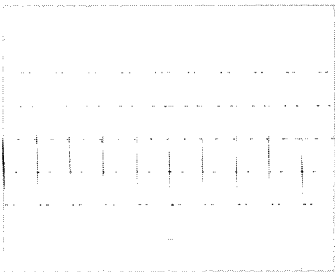
Press	Display	Comments
		<p>The program is executed command-by-command beginning with the first command of line 000. The lighted BUSY indicators are the only indication that you will have that this program is executing.</p>

Vary the output amplitude of the function generator until the BUSY lights go out. Verify that the program has been executed by first setting the STORED INTensity control to quarter range. Now:

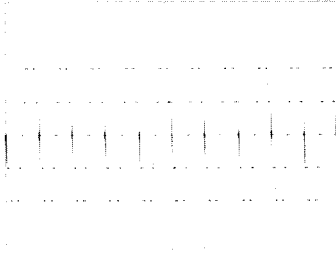
Press	Display	Comments
		<p>The contents of 0 WFM are displayed. Notice that the current program line number () is displayed in display line 16 near the right edge of the graticule. This indicates which programmed STOP caused the interruption.</p>

CLEARING THE PROGRAM

To clear the entire contents of the program memory, which in this case is the introductory program, first return to the Edit mode by pressing **PROG**. Then:

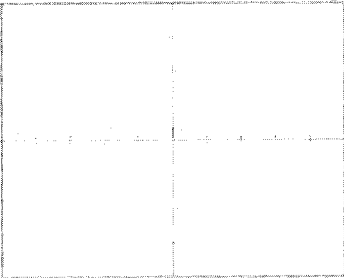
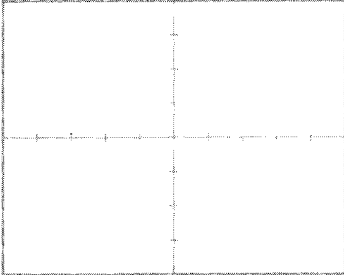
Press	Display	Comments
 CLP		A warning ¹ is issued and the crt displays only the statement "NEXT TO CONFIRM CLEARING".
NEXT		The program memory is cleared.

If after the CLP is issued you don't want to clear the program memory, simply issue any command other than NEXT and the CLP command will be aborted.

If you have more than one program stored and you want to clear a selected program and not the entire program memory, use the CLL (Clear Line) command as described later under Editing a Program.

CLP Operation: The CLP command must be followed with the NEXT command in order to clear the program memory. After the CLP command is issued the display shows only the statement: `PREPARE NEXT TO CONFIRM CLEARING`.

If the following command issued is not NEXT, the CLP command is aborted.

CLP Restrictions: If the CLP command is not issued in the Edit or Entry mode, CLP ERROR results.

¹The warning message of `PREPARE NEXT TO CONFIRM CLEARING` is not displayed for this warning.

PROGRAMMING TECHNIQUES

In the Introductory Program exercises just performed, you entered and executed a program that computed a $\pm 10\%$ amplitude window for a waveform. This program, when entered into the program memory, consisted of the following four major parts: (1) The beginning, (2) the initialization, (3) the body, and (4) the ending. All 7854 programs should contain these four parts, although they need not be entered sequentially due to the power of such programming features as branches and subroutines. However, we recommend that you try to keep these parts sequential in the program memory until you are comfortable with 7854 programming. Flowcharts should be used when writing programs to keep track of the different parts of the programs.

FLOWCHARTS

A flowchart should be used when writing a program to outline the process used by the program to solve a problem. With up to 1000 program lines available, you could quite easily get lost while creating a long program. A flowchart, in addition to documenting your program, will help you design programs by breaking them into smaller groups of commands.

Flowcharting symbols vary from source to source; however, in this manual we will use ovals to represent the beginning and end of a program or routine, and rectangles to represent groups of commands. Diamonds will be used to represent decisions where a choice of two outputs can be made.

You can make your flowcharts as basic or as detailed as you like. At times your flowchart may exactly duplicate the programmed commands; and at other times, having several command groups represented by a single block in the flowchart could be more useful.

Flowcharts should be drawn linearly, from the top of the page to the bottom, reflecting the flow of the program from beginning to end. Use the flowcharts given throughout the rest of this section to help you understand the features of programming with the 7854. Then draw your own flowcharts to help you write, edit, and document your programs.

Figures 6-6 and 6-7 both show flowcharts for the Introductory Program. Neither is more correct than the other; however, the flowchart shown in Figure 6-7 would be more help in creating a specific program. Make your flowcharts as detailed as required to aid in documenting your programs or routines. Figure 6-8 gives a flowchart for a pulse-measuring program.

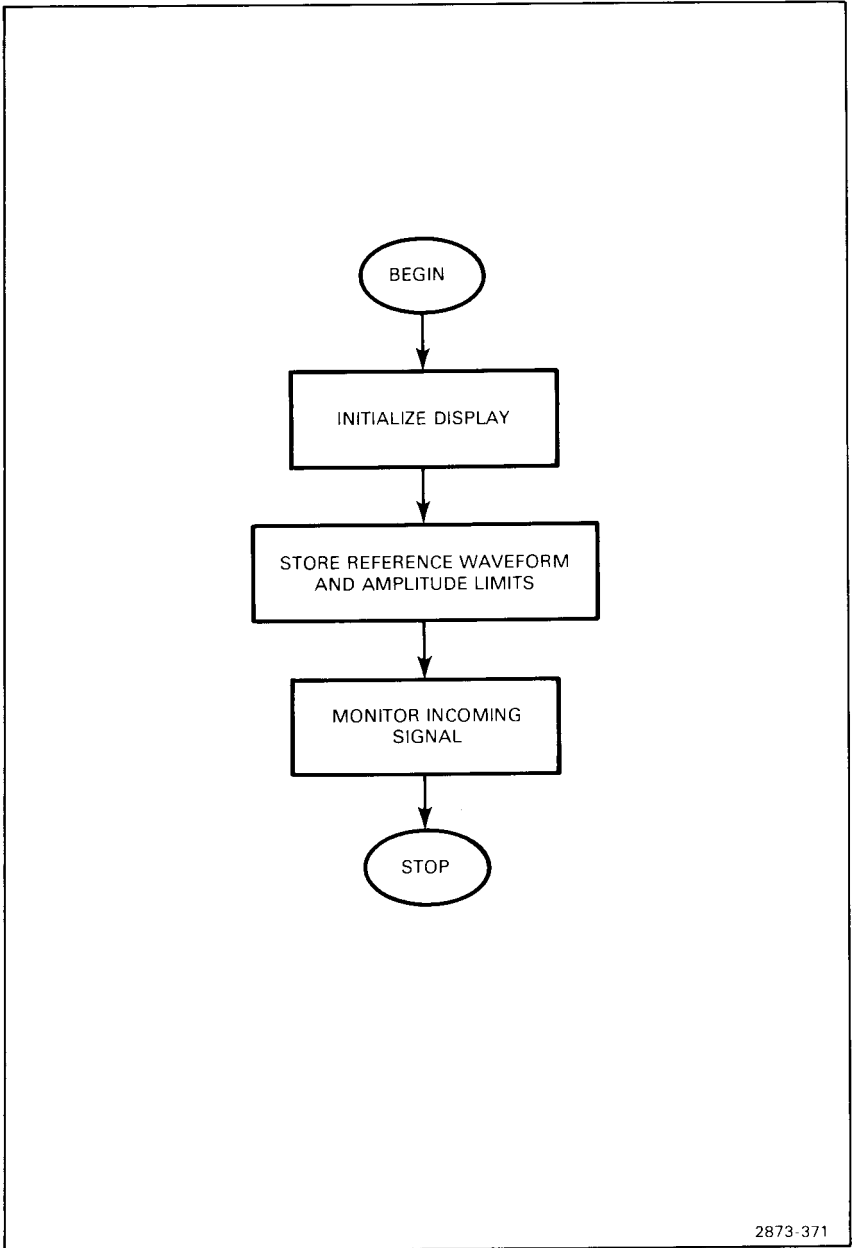
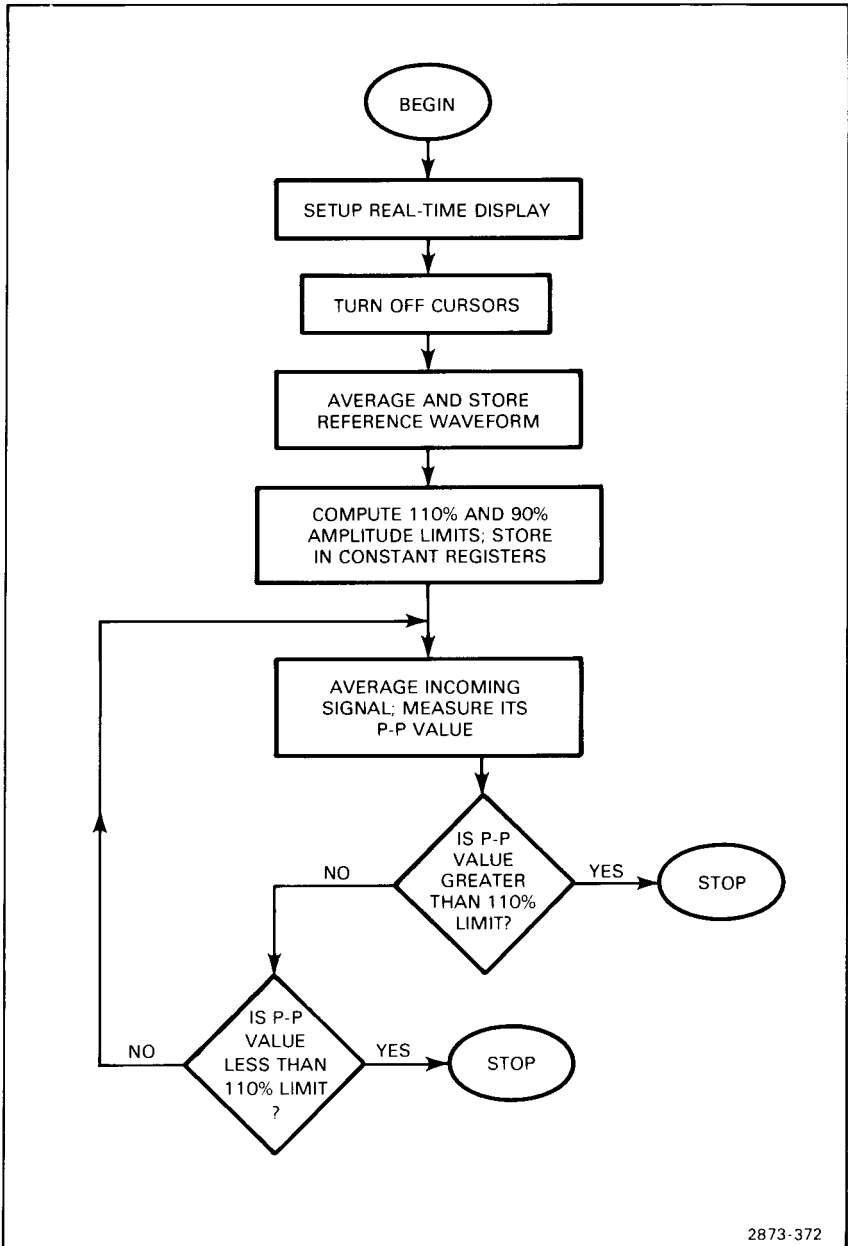

Figure 6-6. Basic flowchart of the introductory program.



2873-372

Figure 6-7. Detailed flowchart of the introductory program.

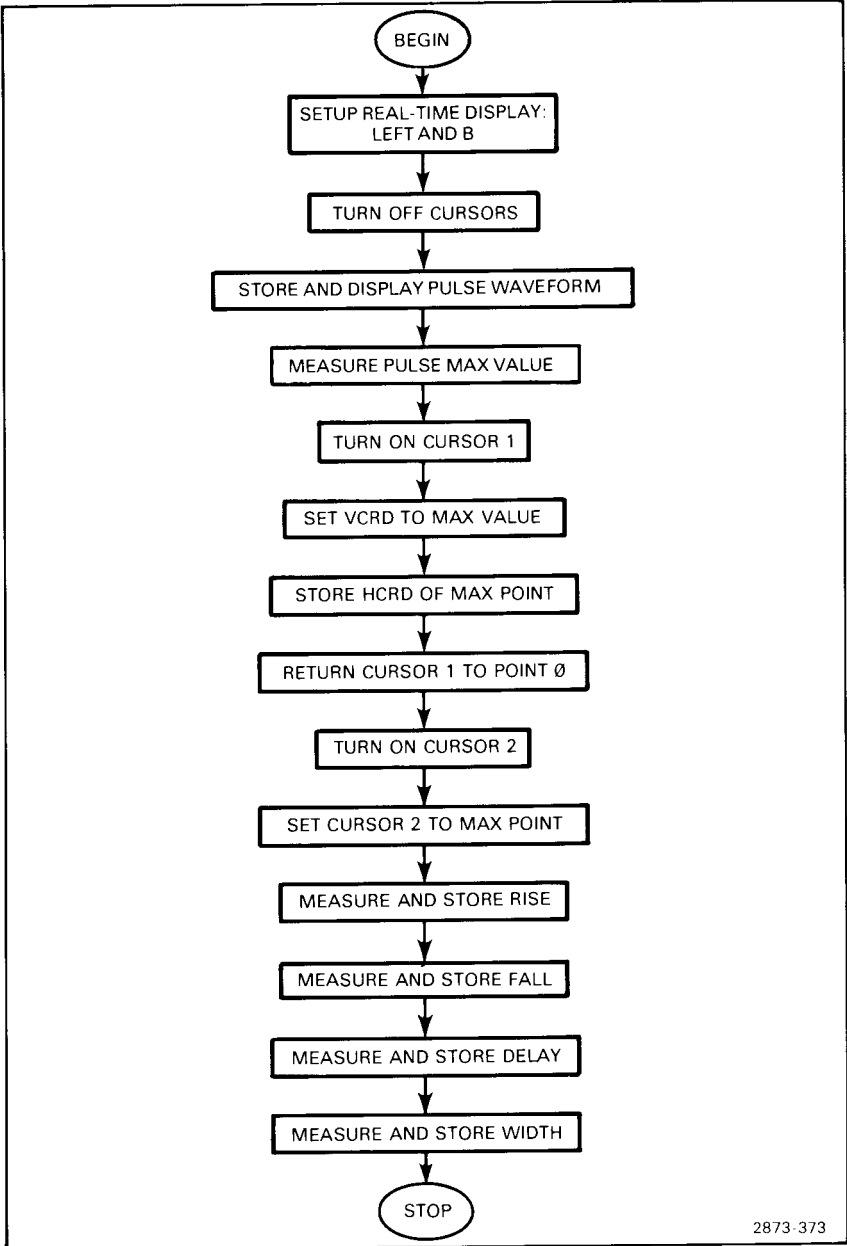

Figure 6-8 Flowchart for the basic pulse-measuring program.

DEFINE PROGRAM BEGINNING

The beginning of every program or routine should always be defined with a label. Labels permit you to have up to 100 uniquely labeled routines (labeled from L00 to L99) in program memory. These routines can be executed in any order desired. For best visual identification of the beginning, don't place any additional commands on the same line. Also, always document the use of each label in program memory as you assign it, since labels can also be used as targets for branches. Be careful not to assign the same label more than once in the program memory because the processor will only find the first occurrence of the label and will ignore any others.

PROGRAM INITIALIZATION

Normally a program or routine will require that certain features (such as the vertical and horizontal modes, the display mode, the stack, the cursors, etc.) be preset to a known condition. This is called initialization and, whenever possible, should be done with programmed commands. Obviously not all features can be set or selected with programmed commands and these will have to be set manually. But, in any case, all initialization should be done prior to executing the program and should be documented thoroughly. A properly initialized program will result in far less errors and mistakes due to improper operands than will a program which was not properly initialized.

THE PROGRAM BODY

The program body consists of the commands executed between the program beginning and ending which either solve a specific problem or process specific data in a predetermined order. The program body could use such features as branches, loops, or subroutines; or it may not use any of these. Whether or not the program body makes use of these programming features will depend upon what the program is to accomplish, as well as your familiarity with these features.

The program body will also include commands to allow you to "view" the program when it is executing, as well as commands to help locate program mistakes (debug).

Unconditional Branching

The stored GOTO (Go To Program Line) command is used to transfer program execution to a specified program line, and should always be used in conjunction with the LBL (Return Label) command. For example, if the processor is executing a program and encounters "6 GOTO", execution is immediately transferred to the first command of program line 006. However, if the processor encounters "GOTO L06", execution is transferred directly to the first command of the line containing label L06, no matter what program line label L06 is in. When a GOTO command is used to transfer program execution as just described, this is called an unconditional branch.

Looping

When program execution is branched to a previous program line, the branch is referred to as a loop. A loop was used in the Introductory Program to repeatedly store and monitor the amplitude of the incoming signal. When used in this manner, to continually update data or perform calculations, the loop is a powerful programming feature.

Conditional Branching

Two commands are available which give the processor the ability to make decisions based on the comparison of the contents of the Y and X registers. These commands, `IF Y > X` and `IF X = J` when stored in a program, will transfer execution based on the results of the comparison. If the specified condition is TRUE, program execution continues with the next command; if FALSE, execution continues with the first command of the next line.

Subroutines

When a group of commands is to be executed several times throughout the program, consider using a subroutine. The GSB (Go to Subroutine) command is used like the GOTO command to transfer program execution to a specified line number, and should also be used in conjunction with the LBL command to branch to the start of the line containing the specified label. However, unlike the GOTO command, when the program next encounters a RTN (Return) command, execution is transferred back to the command following the calling GSB. Execution then continues sequentially through program memory.

Subroutines can contain a loop, or can be executed as part of a loop. Also, a subroutine can call another subroutine; this is known as "nesting". Subroutine nesting is limited by the number of RTNs that the processor can keep pending. In the 7854 up to 10 subroutines can be nested. However, when using subroutines keep in mind that whenever the end-of-program line is reached by the processor, the subroutine return register is cleared.

DEFINE PROGRAM ENDING

The program ending should be defined with a programmed STOP. When the processor is executing a program and encounters a stored STOP command, execution is halted and the processor goes to the idle state. A label accompanying the STOP can be used to differentiate between the end-of-program STOP and other stored STOPS. This is most useful when searching for program mistakes (debugging). Again, be sure to document the use of the assigned label(s).

WRITING A PROGRAM





The process used to write any program can be separated into the following four steps: (1) Define the program objective (2) detail the intended flow of the program with a flowchart (3) translate the flowchart statements into specific commands, and (4) enter the program. The following exercises will illustrate this process. The location of the keys demonstrated here are shown in Figure D, blocks 1 and 19.



























CREATING A PULSE-MEASURING PROGRAM

The first step when writing any program is to define the objective. We will now create a program to store a selected pulse waveform; then measure and store the associated RISE, FALL, DELAY, and WIDTH parameters.

Now that the program objective is defined, we need a flowchart. Try to be as specific as possible when making flowcharts to aid yourself in translating the flowchart into specific 7854 commands. Figure 6-8 is a flowchart for our pulse-measuring program.

After you are satisfied that your flowchart is as complete and detailed as you require, translate the flowchart statements into specific command groups. Let's now do this for our pulse-measuring program:

Flowchart Statements	Commands	Comments
Begin	 LNN $\emptyset\emptyset$	Assign label $\emptyset\emptyset$ to the program beginning.
Setup real-time display: LEFT and B.	SCOPE Vertical Mode: LEFT Horizontal Mode: B	Select the real-time LEFT VERT and B HORIZ compartments for display.
Turn off cursors	OFF	
Store and display pulse waveform.	AQR 2  WFM STORED	Acquire the real-time pulse and store in 2 WFM; select STORED display.
Measure pulse MAX point.	MAX \emptyset  CNS	Measure MAX and store value in \emptyset CNS.
Turn on Cursor 1.	 CRS1	

Flowchart Statements	Commands	Comments
Set VCRD to MAX value.	0   	Return MAX value from 0 CNS to X register; set Cursor 1 to the MAX point by changing the VCRD to this value.
Store HCRD of MAX point.	 1  	Store position of MAX point in 1 CNS.
Return Cursor 1 to point 0.	0  	Return Cursor 1 to point 0 by setting the HCRD to 0.
Turn on Cursor 2		
Set Cursor 2 to MAX point.	1   	Return position of MAX point from 1 CNS to X register; move Cursor 2 to this position by changing the HCRD.
Measure and store RISE.	 2  	Store RISE time in 2 CNS.
Measure and store FALL.	  3  	Store FALL time in 3 CNS.
Measure and store DELAY.	 4  	Store DELAY time in 4 CNS.
Measure and store WIDTH.	 5  	Store WIDTH in 5 CNS.
STOP		Identify end-of-program with STOP.

Now you're ready to enter the program into the 7854 program memory.

ENTERING THE PULSE-MEASURING PROGRAM

NOTE

A complete listing of the entered program is given at the end of this exercise in Figure 6-9. Consulting this listing while entering the program may be helpful.

Press

PROG

Comments

Invoke the Edit mode.

 **LNN** 00

Enter label L00 to identify the program beginning.

LNN Operation: The LNN command, when executed, starts a label in the program. This command must be followed by two digit commands to complete the label. Initially the label is displayed as LNN; however the first N is then replaced with the first digit entered, and the second N with the second digit.

LNN Restrictions: The LNN command is executed only when the processor is in the program Entry mode, and must be followed either by the CLL (Clear Line) command or by two successive digit commands. Otherwise, LNN ERROR is issued, although the message is only displayed in the STORED or BOTH modes.

Continue entering the program:

Press

NEXT

Comments

Advance the edit prompt to the following program line. A warning¹ is issued whenever a new line is started.

NEXT Operation: When the NEXT command is issued in the Entry mode, the entry line is terminated (line number assigned), and the edit prompt is advanced to the next program line. If the NEXT command is issued in the Edit mode, the edit prompt is advanced to the next program line.

If the **NEXT** key is held down after the initial actuation, the edit prompt increments through the existing program lines (if any) toward the end-of-program line.

¹The warning message of XXX WARNING is not displayed for this warning.

ENTERING THE PULSE-MEASURING PROGRAM (Cont)

Automatic NEXT Operation: Whenever a command is issued which causes the program entry line to exceed the 35 character line length limit, an automatic NEXT is executed. At this time a line number is assigned to terminate the full line, a new line is started with the last entered command, and a warning¹ is issued.

NEXT Restrictions: The NEXT command is executed only in the Entry or Edit modes, and only if the current program line is *not* the end-of-program line. **NEX ERROR** is issued if any of these restrictions are violated, although the error message is only displayed if the command was issued over the GPIB while in the Execute mode.

Now, enter the remaining commands of the pulse-measuring program (using the NEXT to separate command groups) by pressing:

SCOPE **LEFT** of VERTICAL MODE **B** of HORIZONTAL MODE **NEXT**

OFF **NEXT**

AQR 2  **WFM** **STORED** **NEXT**

MAX 0  **CNS** **NEXT**

 **CRS1** **NEXT**

0 **CNS**  **VCRD** **NEXT**

HCRD 1  **CNS** **NEXT**

0  **HCRD** **NEXT**

CRS2-1 **NEXT**

1 **CNS**  **HCRD** **NEXT**

RISE 2  **CNS** **NEXT**

¹The warning message of XXX WARNING is not displayed for this warning.

ENTERING THE PULSE-MEASURING PROGRAM (Cont)

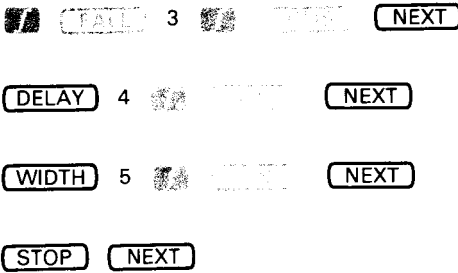

The pulse-measuring program is now stored in program memory.

```
000 L00
001 SCOPE VMDL HMDB
002 OFF
003 AQR 2 >WFM STORED
004 MAX 0 >CNS
005 CRS1
006 0 CNS >VCRD
007 HCRD 1 >CNS
008 0 >HCRD
009 CRS2-1
010 1 CNS >HCRD
011 RISE 2 >CNS
012 FALL 3 >CNS
013 DELAY 4 >CNS
014 WIDTH 5 >CNS
015 STOP
```

2873-375

Figure 6-9. Listing of the basic pulse-measuring program.

EXECUTING A PROGRAM

As previously explained, a 7854 program can be executed in either of two states: Run or Step. The following exercises demonstrate the use of each state. Figure D, block 19 shows the location of the keys demonstrated here.

STARTING THE PULSE-MEASURING PROGRAM

With the pulse-measuring program stored in the program memory, return to the idle state by pressing **EXECUTE**.

Connect an 8-volt (peak-to-peak) 1-MHz square wave to the LEFT VERT amplifier unit from a function generator. (Recommended type: TEKTRONIX FG 503 Function Generator used with a TM 500 Power Module.)

Set the B HORIZ time-base unit for a 100 nanosecond/division sweep rate using a 1 microsecond/division setting with X10 magnification.

If necessary, return to the SCOPE display mode by pressing **SCOPE**.

Adjust the deflection factor of the LEFT VERT amplifier unit to display about four divisions of signal. Vertically center the display.

Using the B HORIZ position control, position a positive-going pulse to horizontal center.

Run the pulse-measuring program from the first command of line 000 by pressing **START**. When the program is finished, the display will appear similar to that shown in Figure 6-10.

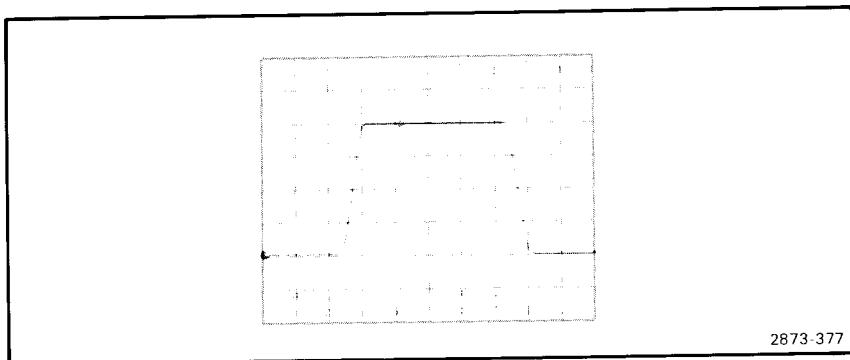

2873-377

Figure 6-10 Typical display after executing the pulse-measuring program.

STARTING THE PULSE-MEASURING PROGRAM (Cont)

START Operation: When the **START** command is directly issued with the processor in the idle state, the processor goes to the Run state and begins executing the program with the first command of line 000. If a stored **START** command is encountered when the processor is in the Run state, program execution is immediately transferred to the first command of line 000. However, if a stored **START** command is encountered when in the Step state, program execution is halted and the processor returns to the idle state with the edit prompt set to line 000. All **START** commands clear the subroutine return register (the register used for tracking RTN commands).

Restrictions: If the command is directly issued but a program is not in the program memory, **STA ERROR** is issued.

RUNNING THE PULSE-MEASURING PROGRAM

When more than one routine is in program memory and you want to execute a selected routine which does not begin at line 000, you must first set the edit prompt to the beginning of the desired routine. Although this can be done manually in the Edit mode, if you have assigned a label to specify the beginning of the program, using directly issued **LBL** and **GOTO** commands can be quicker.

For example, at this time the edit prompt is at program line 015, and we want to execute the program which begins with label L00. (Although in this case the label is at line 000, it might not always be at this line number.)

Press

0  **LBL** **GOTO**

Comments

The displayed program status changes from **PL 15** to **PL 0** to indicate that the edit prompt has moved to line 000, which is the first occurrence of label L00. **GOT WARNING** is issued if the constant in the X register was greater than the last assigned program line number. Also, this causes the edit prompt to be set to the blank end-of-program line, the program line number to be blanked from the **STORED** or **BOTH** display, and the processor to return to the idle state.

RUNNING THE PULSE-MEASURING PROGRAM (Cont)

At this time you can execute the program beginning with the first command of the current program line by pressing **RUN**. Notice that the pulse-measuring program is again executed.

LBL Operation: The program line number containing the first occurrence of the label specified in the X register is returned to the X register.

LBL Restrictions: The X register must contain a constant which, when rounded to the nearest integer, is from 0 to 99 (inclusive) and represents a label which occurs at least once in the program memory. **ERR** is issued if either restriction is violated prior to execution of the LBL command.



GOTO Operation: When the GOTO command is directly issued, the edit prompt is moved to the program line specified by the number in the X register; but, the processor remains in the idle state. When a stored GOTO command is encountered with the processor in the Run state, program execution is continued at the first command of the program line specified by the number in the X register. However, when a stored GOTO command is encountered in the Step state, the edit prompt is then moved to the program line specified in the X register.

GOTO Restrictions: The X register must contain a constant which, when rounded to the nearest integer, is from 0 to 999 inclusive. **ERR** is issued if this restriction is violated prior to execution of the GOTO command.

RUN Operation: The processor goes to the Run state of the program Execute mode when the RUN command is executed. Stored commands are sequentially executed in the Run state.

RUN Restrictions: If the RUN command is issued when the edit prompt is at the end-of-program line, or when a program has not been stored, **ERR** is issued and the processor will not go to the Run state.



STEPPING THROUGH THE PULSE-MEASURING PROGRAM

Programs can be executed one line at a time by using the Step state of the Execute mode. Set the edit prompt to the beginning of the pulse-measuring program by pressing \emptyset   .

To Execute the command group of the current program line:

Press	Comments
	The command group of the current program line is executed. Since the only command on this line was a label, the LNN mnemonic is displayed and the edit prompt is advanced a line as indicated by <code>PC 1. STEP WARNING</code> is issued if the edit prompt is at the end-of-program line.

Continue stepping through the pulse-measuring program with the . The display will change to the real-time pulse, and (after two more STEP commands) will reacquire and display the stored pulse. Refer to the listing given in Figure 6-9 as you step through the program to verify that the program is indeed being executed by command groups.

Notice that when you reach program line 15 execution is stopped by the stored STOP command. If  is pressed again, the processor finishes executing any commands remaining on this line. The next  brings us to the end-of-program line where `PC 1. STEP WARNING` is issued.

STEP Operation: The processor goes to the Step state of the program Execute mode when the STEP command is executed. This command is not programmable. In the Step state, the commands on the current program line are sequentially executed, the edit prompt is advanced to the next line, and the processor returns to the idle state. However, if the line contains a stored STOP or RUN command, the processor will either stop or switch to the Run state, respectively.

NOTE

The STEP command will not terminate numeric entry into the X register.

EDITING A PROGRAM

The editing commands of NEXT, PREV, and CLL are provided to aid you in altering programs already stored in program memory without necessitating a complete re-entering of the altered program. If, however, the existing program is to be drastically changed, you may want to use the **CLL** command to clear the program memory and then enter the newly written program. These exercises will demonstrate the editing commands, as well as the conditional statements (**IF** and **IFY>X**) and the subroutine commands (**GSB** and **STN**). The location of these keys are shown in Figure D, block 19.

ALTERING THE PULSE-MEASURING PROGRAM

Figure 6-11 shows a modified flowchart of the pulse-measuring program. We have added a loop to the flowchart which will stop the program after executing it ten times, and we are now going to alter the existing program to do the same.

Perform the previous exercise for Stepping Through a Program. Then return the existing program to the display by pressing **PROG**.

Manually move the edit prompt back through the existing lines to line 002 by pressing and holding the **PREV** as necessary.

PREV Operation: The edit prompt is backed to the previous program line. If the **PREV** command is issued in the Entry mode, the current program line is terminated. If the **PREV** key is held down, the edit prompt will decrement through the program lines until released or until line 000 is reached.

PREV Restrictions: If the **PREV** command is directly issued in the Execute mode, or if the current program line is 000, **ERR 00000** is issued. The error message will only be displayed in the **STORED** or **ROTH** mode.

To enter the commands which will initialize the loop counting register (6 CNS):

Press	Comments
0 ENTER 6	This will place a 0 in 6 CNS when the program is first run. Notice that a new entry line was opened prior to what had been line 003. The newly issued commands are entered here.

Exercise continues on next page

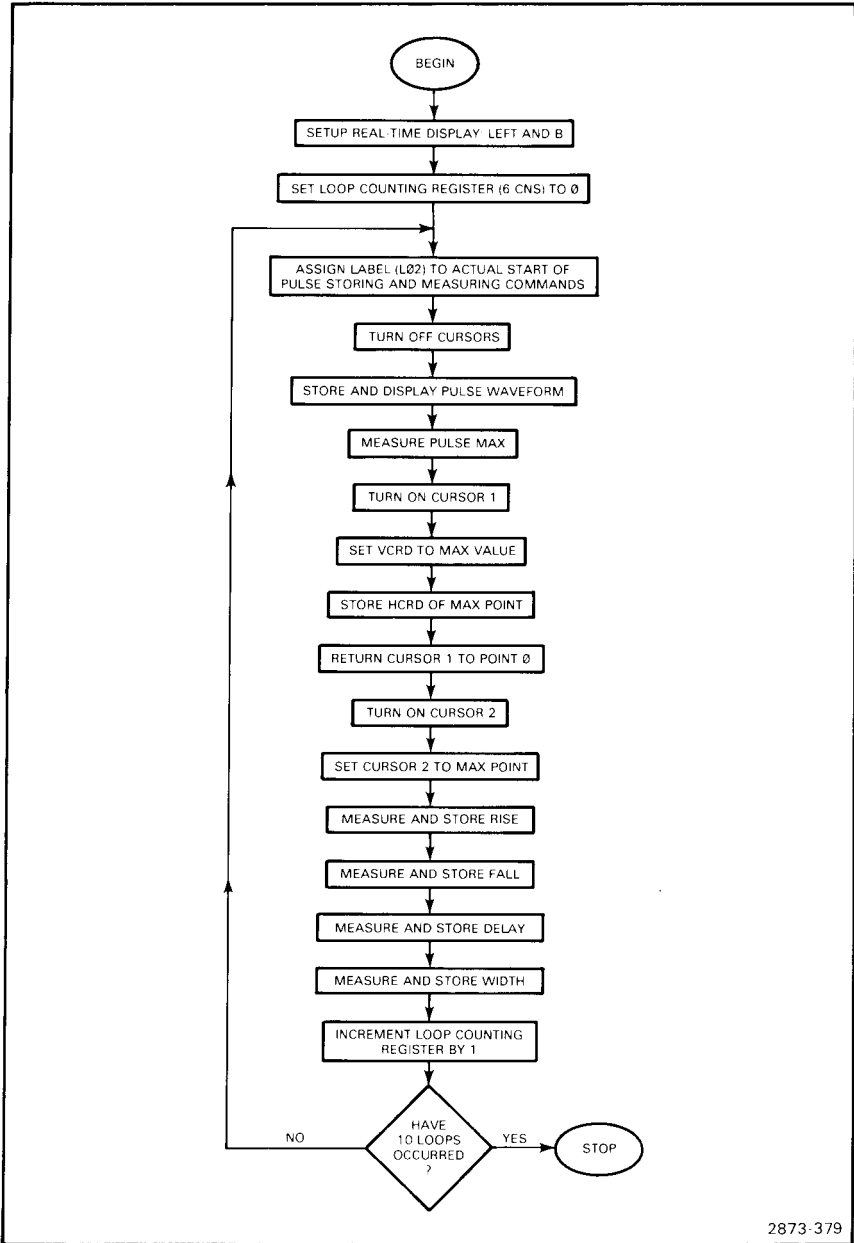

Figure 6-11. Flowchart for the pulse-measuring program using a loop.

ALTERING THE PULSE-MEASURING PROGRAM (Cont)

Now, terminate this entry line and advance the edit prompt to the following line by pressing **NEXT**. Then:

Press	Comments
f LNN 02 OFF	The label L02 is assigned to the start of the commands to store and measure the pulse. Add the command to turn off the cursors.

Remove the duplicated OFF command by pressing **NEXT** **CLL**. Notice that the line containing the duplicated OFF command has been deleted, and that the following command groups have all been moved up one line to close the gap.

CLL Operation: When the CLL command is issued the commands on the current program line are removed and all command groups following it are moved up one line.

CLL Restrictions: If the CLL command is issued when the processor is in the Execute mode, or when the edit prompt is at the end-of-program line, is issued. The error message is only displayed in the STORED or BOTH modes.

Advance the edit prompt to what is now program line 016 by pressing and holding down the **NEXT**. To increment the loop counting register and add the conditional loop:

Press	Comments
6 CNS 1 + 6 f >CNS NEXT	This will increment 6 CNS by 1.
6 CNS 10 f IFX=1 STOP NEXT 2 f LBL GOTO	The contents of 6 CNS will be compared with the value of 10. If they are equal the program will stop; otherwise program execution is transferred to label L02.

Exercise continues on next page

ALTERING THE PULSE-MEASURING PROGRAM (Cont)

IFX=Y' Operation: When the **IFX=Y'** command is executed, the processor compares the contents of the X register to that of the Y register. If both registers contain constants at the time of the comparison, the result is TRUE when the constants have identical values. If both registers contain waveform memory addresses, the processor compares corresponding pairs of points on the referenced waveforms (between cursors, if on); the result is TRUE when the difference between all compared points is zero. If one register contains a constant and the other contains a waveform memory address, each point of the waveform (between cursors, if on) is compared to the constant value; the result is TRUE when all compared waveform points do not vary from the value of the constant. Scale factor units are ignored if they differ. After execution of a stored **IFX=Y'** command, program execution continues normally with the next command if the result was TRUE. Otherwise, program execution continues at the start of the next program line (if comparison results are FALSE). Test results, TRUE or FALSE, are displayed in line 16 of the STORED or BOTH mode.

A complete listing of the pulse-measuring program with a conditional loop is given in Figure 6-12.

```

000  L00
001  SCOPE VMDL HMDB
002  0 ENTER 6 >CNS
003  L02 OFF
004  AQR 2 >WFM STORED
005  MAX 0 >CNS
006  CRS1
007  0 CNS >VCRD
008  HCRD 1 >CNS
009  0 >HCRD
010  CRS2-1
011  1 CNS >HCRD
012  RISE 2 >CNS
013  FALL 3 >CNS
014  DELAY 4 >CNS
015  WIDTH 5 >CNS
016  6 CNS 1 + 6 >CNS
017  6 CNS 10 IFX=Y STOP
018  2 LBL GOTO
019  STOP

```

2873-380

Figure 6-12. Listing of the pulse-measuring program with a loop.

Execute the modified program by pressing **EXECUTE**  **START**. When the program stops, check the contents of 6 CNS (the loop-counting register) by pressing 6 **CNS** to verify that the loop was executed 10 times.

USING SUBROUTINES

The commands used in the pulse-measuring program to position Cursor 1 to point 0 and Cursor 2 to the MAX point could be useful for other programs; so let's put them in a subroutine that can be accessed by other programs. Also, let's add a subroutine which will monitor the amplitude of the pulse and stop the program when the amplitude is not between 7 and 9 volts (peak-to-peak). Figure 6-13 gives a flowchart for the main program, Figure 6-14 gives one for the cursor-positioning subroutine, and Figure 6-15 gives one for the amplitude-monitoring subroutine.

To avoid possible confusion we will completely re-enter the new version of the pulse-measuring program. So clear the present program from the memory by pressing **PROG** **↵** **CLP** **NEXT**.

Again, translate the flowchart of Figure 6-13 into specific command groups and enter them into the 7854 by pressing:

↵ **LNN** 00 **NEXT**

SCOPE VERTICAL MODE **LEFT** HORIZONTAL MODE **B** **NEXT**

0 **ENTER** 6 **↵** **CNS** **NEXT**

↵ **LNN** 02 **AQR** 2 **↵** **STOP** **STORED** **NEXT**

3 **↵** **LBI** **GSB** **NEXT**

GSB Operation: When the GSB is executed the edit prompt is moved to the line specified in the X register. If the program was running at the time the GSB was encountered, program execution is transferred to the first command of the specified line. The subroutine return register is set to point to the next command following the GSB.

NOTE

The GSB command will not terminate numeric entry.

GSB Restrictions: The X register must contain a constant which, when rounded to the nearest integer, is from 0 to 999 inclusive. Also, not more than 10 levels of nesting can be issued. **GSB ERROR** is issued if either restriction is violated; although the error message is only displayed in the **STORED** or **STOP** mode.

Exercise continues on next page

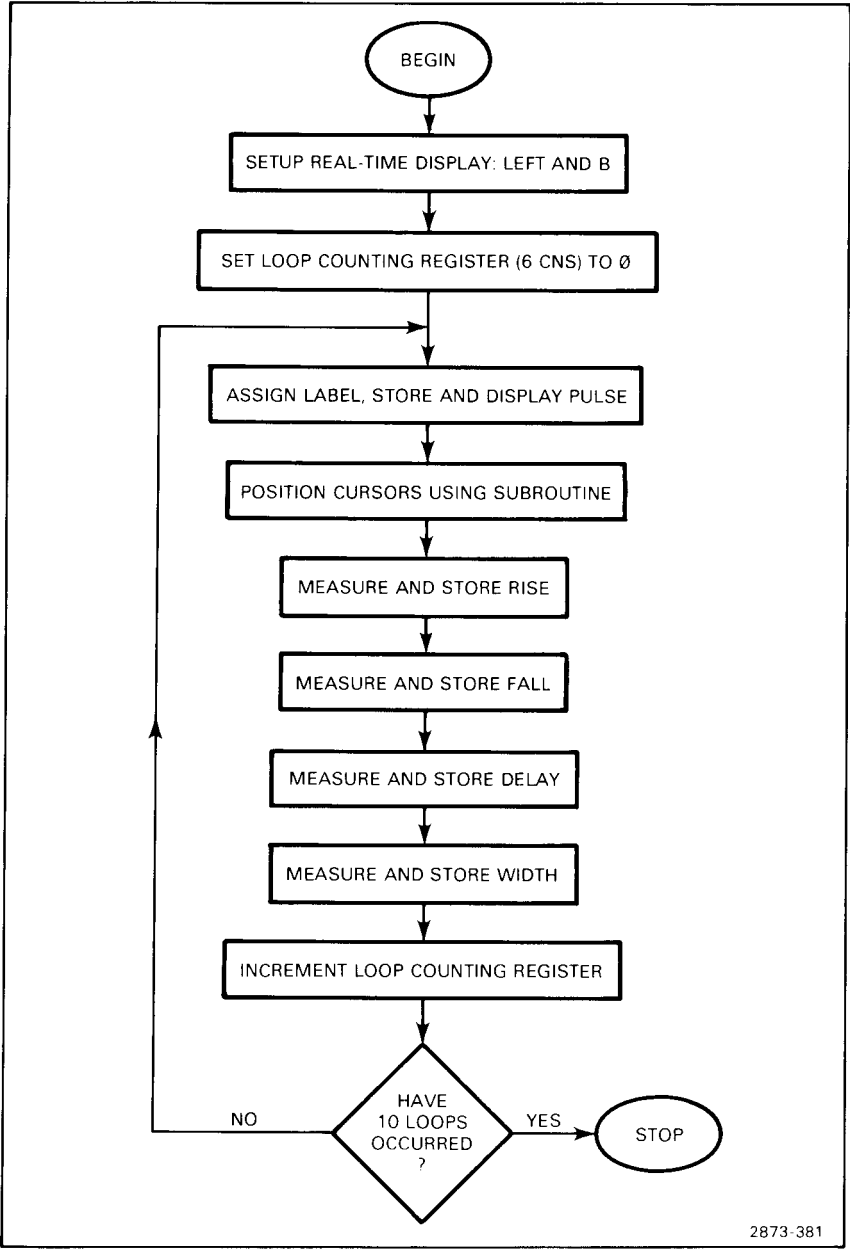

Figure 6-13 Flowchart of main body of the pulse-measuring program using subroutines.

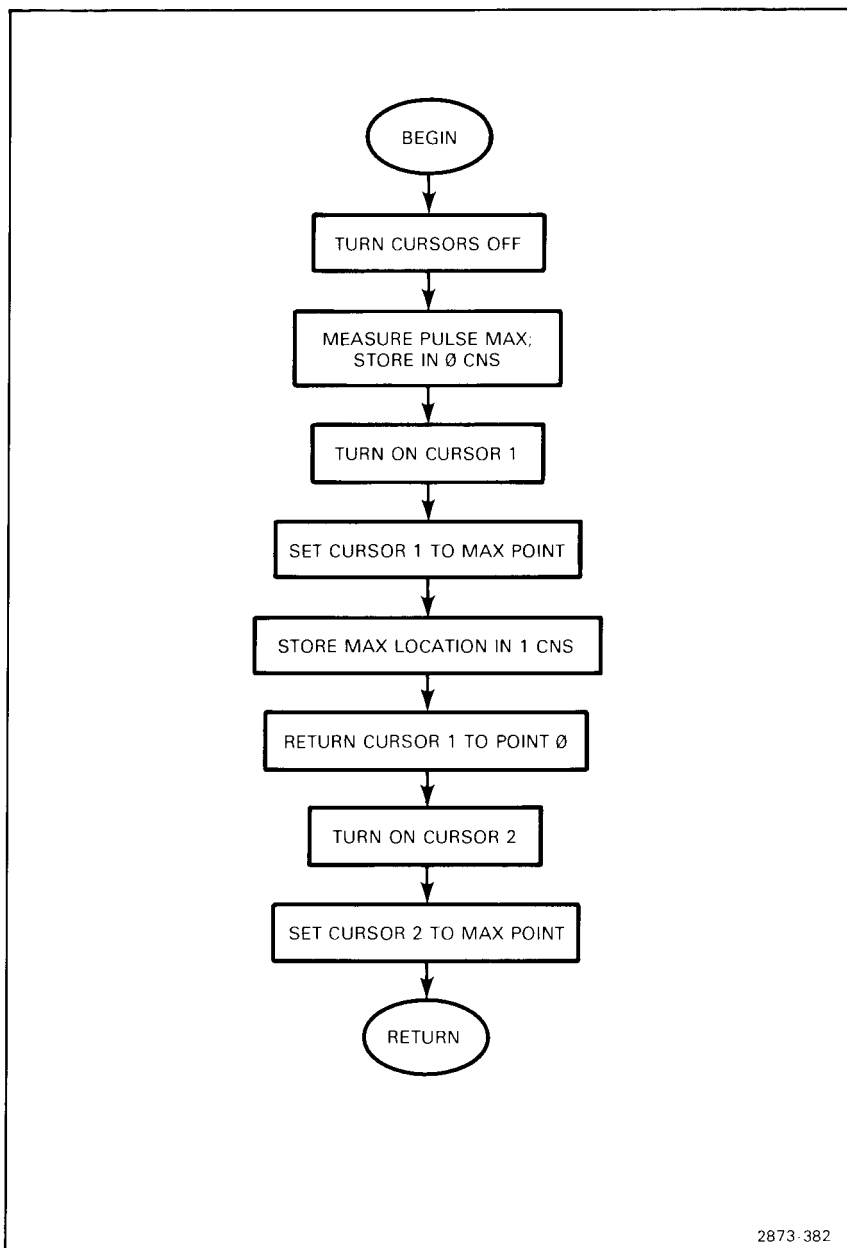
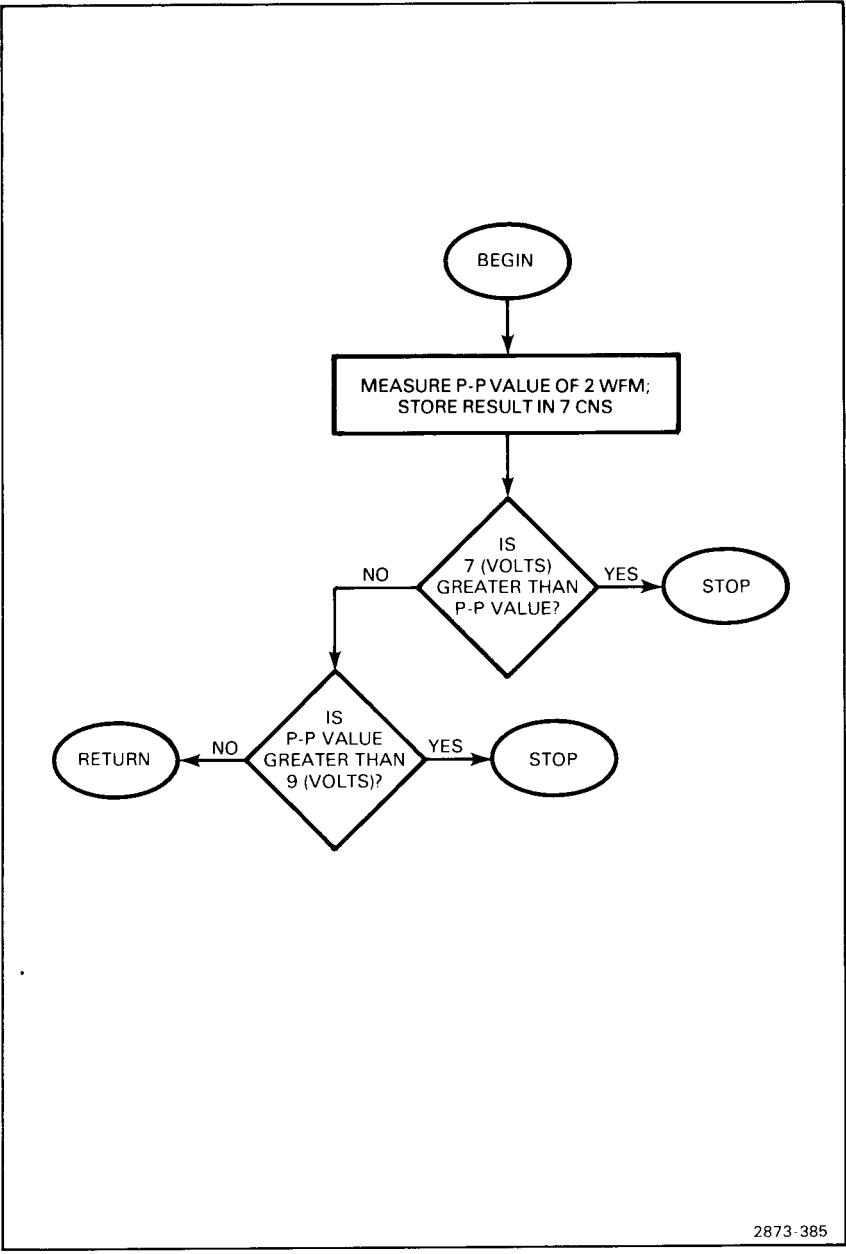

Figure 6-14. Flowchart of the cursor-positioning subroutine.



2873-385

Figure 6-15. Flowchart of the amplitude-monitoring subroutine.

USING SUBROUTINES (Cont)

Continue entering the program by pressing:

RISE 2  CNS NEXT FASH 3  CNS NEXTDELAY 4  CNS NEXTWIDTH 5  CNS NEXT6 CNS 1 + 6  CNS NEXT6 CNS 10  IFX=F STOP NEXT2  LRL GOTO NEXTSTOP  LNN 01 NEXT

Now enter the cursor positioning-subroutine by pressing:

 LNS 03 NEXT

OFF NEXT

MAX 0  CNS NEXT GRS NEXT0 CNS  VCRD NEXTHCRD 1  CNS NEXT*Exercise continues on next page*

USING SUBROUTINES (Cont)



0  >HCRD NEXT

CRS2-1 NEXT

1 CNS  >HCRD NEXT RTN

RTN Operation: When the RTN command is executed, the edit prompt is moved to the line holding the calling GSB command, and the next executed program command (as indicated by the subroutine return register) is the one following the GSB.

RTN Restrictions: The RTN command is issued if the RTN command was executed without a calling GSB.

Refer to Figure 6-16 for a listing of the program memory at this time. Then run the program. (Press   START.)

```

000 L00
001 SCOPE VMDL HMDB
002 0 ENTER 6 >CNS
003 L02 AQR 2 >WFM STORED
004 3 LBL GSB
005 RISE 2 >CNS
006 FALL 3 >CNS
007 DELAY 4 >CNS
008 WIDTH 5 >CNS
009 6 CNS 1 +6 >CNS
010 6 CNS 10 IFX=Y STOP
011 2 LBL GOTO
012 STOP L01
013 L03
014 OFF
015 MAX 0 >CNS
016 CRS1
017 0 CNS >VCRD
018 HCRD 1 >CNS
019 0 >HCRD
020 CRS2-1
021 1 CNS >HCRD
022 RTN

```

2873-383

Figure 6-16 Listing of pulse-measuring program and cursor-positioning subroutine.

USING SUBROUTINES (Cont)

Now, let's enter the amplitude-monitoring subroutine to be nested within the cursor-positioning routine.

First press **PROG** to return to the program Edit mode. Now advance the edit prompt to line 022 with the **NEXT**. Enter the calling commands by pressing 4 **LBL** **GSB**. Advance the edit prompt, again by using the **NEXT**, to the end-of-program line.

Now enter the amplitude-monitoring subroutine by pressing:

```

LBL LNN 04 NEXT

2 WFM P-P 7 LBL >CNS NEXT

7 ENTER 7 CNS IFY>X STOP NEXT

7 CNS ENTER 9 IFY>X STOP NEXT

LBL RTN

```

A complete listing of both subroutines is shown in figure 6-17.

```

013 L03
014 OFF
015 MAX 0 >CNS
016 CRS1
017 0 CNS >VCRD
018 HCRD 1 >CNS
019 0 >HCRD
020 CRS2-1
021 1 CNS >HCRD
022 4 LBL GSB
023 RTN
024 L04
025 2 WFM P-P 7 >CNS
026 7 ENTER 7 CNS IFY>X STOP
027 7 CNS ENTER 9 IFY>X STOP
028 RTN

```

2873-386

Figure 6-17. Listing of the cursor-positioning and amplitude-monitoring subroutine.

Exercise continues on next page

USING SUBROUTINES (Cont)

IFY>X Operation: When the IFY>X command is executed, the processor compares the contents of the X register to that of the Y register. If both registers contain constants at the time of comparison, the result is TRUE when the constant in the Y register is more positive than the constant in the X register. If both registers contain waveform memory addresses, the processor compares corresponding pairs of points on the referenced waveforms (between cursors, if on); the result is TRUE when even one point of the Y register referenced waveform is more positive than the value of the corresponding point of the X register referenced waveform. If one register contains a constant and the other contains a waveform memory address, each point of the waveform (between cursors, if on) is compared to the constant value; the result is TRUE when the value in the Y register (either constant or referenced waveform point) is more positive than that in the X register.

After execution of a stored IFY>X command, program execution continues normally with the next command if the result was TRUE. Otherwise, program execution continues at the start of the next program line. Test results, TRUE or FALSE, are displayed in line 16 of the STORED or BOTH mode.

PROGRAM INTERRUPTIONS

In addition to having a program stop execution as a result of a decision, you will often want to stop execution in order to input new data or to pause during execution to view results. The stored STOP and PAUSE commands, or a directly issued STOP command, can be used to interrupt program execution as demonstrated in the following exercises. See Figure D, block 19 for the location of these keys on the Waveform Calculator.

USING THE STORED STOP

When a stored STOP command is executed by a running program, program execution stops.

To demonstrate, run the pulse-measuring program now in the 7854 program memory:

Press



Comments

The program is executed and then stops when the stored STOP is encountered on line 010. The processor returns to the idle state. Notice that the truncated mnemonic of the command prior to the stored STOP, plus the status message STOP, are displayed in line 16.

USING THE STORED STOP (Cont)

Stored STOP Operation: When the processor encounters a stored STOP command in either the Run or Step state, program execution is stopped. At this time the processor returns to the idle state and displays the previously executed command mnemonic (except STOP or PAUSE) plus the status message . If you press

EXECUTE **RUN** without having moved the edit prompt, execution will begin with the command following the STOP.

NOTE

The STOP command (stored or direct) will not terminate numeric entry into the X register.

PAUSING TO VIEW PROGRAM RESULTS

The stored PAUSE command is used to "slow down" a program during execution to allow you to view the displayed results. Executing a stored command will momentarily interrupt the program execution. The length of the interruption can be extended by storing two or more successive PAUSE commands.

Let's now add stored PAUSE commands to interrupt the existing program after the RISE, FALL, DELAY, and WIDTH commands.

Now move the edit prompt to line 005 using the **PREV**.

To add the PAUSE commands:

Press	Comments
1 RISE PAUSE PAUSE 2 CNS NEXT CLL	Insert commands after RISE by entering the new command group and deleting the old line.
3 FALL PAUSE PAUSE 4 CNS NEXT CLL	Insert commands after .
5 DELAY PAUSE PAUSE 6 CNS NEXT CLL	Insert commands after DELAY.
7 WIDTH PAUSE PAUSE 8 CNS NEXT CLL	Insert commands after WIDTH.

Exercise continues on next page

PAUSING TO VIEW PROGRAM RESULTS (Cont)

See Figure 6-18 for a listing of the main program at this time.

```
000 L00
001 SCOPE VMDL HMDB
002 0 ENTER 6 >CNS
003 L02 AQR 2 >WFM STORED
004 3 LBL GSB
005 RISE PAUSE PAUSE 2 >CNS
006 FALL PAUSE PAUSE 3 >CNS
007 DELAY PAUSE PAUSE 4 >CNS
008 WIDTH PAUSE PAUSE 5 >CNS
009 6 CNS 1 + 6 >CNS
010 6 CNS 10 IFX=Y STOP
011 2 LBL GOTO
012 STOP L01
```

2873-384

Figure 6-18. Listing of the pulse-measuring program with commands added to view results.

PAUSE Operation: The PAUSE command interrupts all command execution for approximately 0.7 second.

NOTE

The command will not terminate numeric entry into the X register.

Return to the Execute mode by pressing **EXECUTE** and then run the program (press **START**). Notice how the program execution is interrupted following the RISE, FALL, DELAY, and WIDTH measurements for each of the 10 successively acquired pulses.

Of course, for the stored PAUSE command to be effective, you must first format the display to show the results you are interested in viewing.

THE DIRECT STOP

Another method used to interrupt a running program is to directly issue a STOP from the keyboard(s). However, if program execution is to be continued after being stopped, you must take care not to alter anything which is required for proper continuation of the program. For example, the stack contents, numeric entry status, cursor status or position, the subroutine return register, waveform memory and constant register contents are all likely to change the outcome of the program if they are altered. Therefore, you may want to avoid using direct STOPS.

THE DIRECT STOP (Cont)

Direct STOP Operation: If the directly issued STOP occurs while the processor is executing the AQR, AVG, AVG10, AVG100, AVG1000, or GND commands (stored or direct), the executing command is prematurely terminated. Otherwise, the processor completes execution of the current command. The processor then returns to the idle state and the truncated mnemonic of the command executing when the STOP was received, plus the **STOP** status message, is displayed in line 16 of the STORED or BOTH mode. If program execution is then resumed with the RUN command, execution begins with the command following the command during which the STOP was received.

PROGRAM EXAMPLES

The following programs are provided as additional program examples. Only the purpose and constraints of each program are explained since you should have a working knowledge of the 7854 commands used in these example programs. Of course, each of these programs can be modified to agree with prior assignments of waveform memory or constant registers. Line numbers have been left off the program listings given here so that you will not be unduly restrained in the use of these programs.

PERCENT OF OVERSHOOT

This program will calculate the percent of overshoot of the operational waveform. After execution, the percent calculated will be displayed in the X register, as well as being stored in 1 CNS. Since this program calculates the percentage rate independently of the VZR setting, the GND need not be set.

Constraints: The 0% level of the operational waveform must be at the left edge of the graticule, and the 100% level must be at the right edge of the graticule. Any number of cycles can be displayed between these two points, provided that all pulses are identical.

```

L01
STORED 4 AVG
CRS 0 >HCRD
VCRD 2 >CNS
CRS2-1 HSCL 10 * ENTER
P/W / - >HCRD
MAX 2 CNS - VCRD / 1 - 100 *
1 >CNS
STOP 1 LBL GOTO

```

2873-387

Figure 6-19. Program to calculate the percent of overshoot.

PROPAGATION DELAY

The propagation delay between the first MID point of each of two signals will be calculated and, after execution, displayed in the X register field. Also, the two signals will be displayed on the screen after execution (and stored in 1 WFM and 2 WFM).

Constraints: The vertical amplifier(s) must not be in the chop mode. The two input signals must have at least one displayed transition (either positive- or negative-going).

```
L01 AQR STORED CLD
CRS1 0 >HCRD OFF
0 WFM MIN -.5 VXP 1 >VZR
0 WFM 2 >WFM
1 WFM MIN -.5 VXP 3CHS >VZR
0 WFM 1 >WFM
1 DSW 2 DSW
CRS1 2 WFM MID >VCRD HCRD 1 >CNS
1 WFM MID >VCRD HCRD 1 CNS - STOP
```

2873-388

Figure 6-20. Program to calculate propagation delay.

CONVOLUTION OF WAVEFORMS

This program will calculate the convolution between an input signal and the impulse response. After execution the result of the convolution is displayed on the graticule (and stored in 0 WFM).

Constraints: The input waveform must be in 1 WFM and the impulse response must be in 0 WFM prior to execution of this program. Also, to avoid time-domain aliasing with nonperiodic signals, both 1 WFM and 0 WFM contents should be zero from the left edge of the graticule to the center vertical graticule line.

```
0 WFM STORED VSCL 1 >CNS
1 WFM 2 >WFM 0 WFM 1 >WFM 0 WFM 0
* P/W 10 / >HSCL
1 WFM CLX >HSCL 2 WFM CLX >HSCL
CLS >CNS
L00 2 WFM 0 CNS PNT 1 WFM CLX 0
IFX=Y 1 LBL GOTO
CLX ENTER ABS >VSCL CLX SGN VXP
1 WFM 0 WFM +
L01 1 WFM 1 HPRGT 0 CNS 1 + 0 >CNS
P/W IFX=Y 0 WFM 1 CNS * STOP
0 LBL GOTO
```

2873-389A

Figure 6-21. Program to convolve waveforms.

SINE OF WAVEFORMS

This program will compute and display the sine of an input waveform.

This program finds the equivalent of the input waveform from $-\pi/2$ to $\pi/2$ by using a mod function, and then uses a 4-turn Taylor series. The sine of the waveform is then displayed from 0 WFM.

NOTE

The cosine of a waveform can be computed by adding $\pi/2$ to the input waveform at the beginning of this program.

Constraints: The input waveform must not exceed $\pm(511*2\pi)$ in magnitude.

```

STORED 0 WFM 1 >WFM SGN 2 >WFM
1 WFM ABS 6.283 / 1 >WFM
256 ENTER 0 >CNS
L00 1 WFM 0 CNS IFY>X 2 LBL GOTO
L01 0 CNS 2 / 0 >CNS .75
IFY>X 0 LBL GOTO
3 LBL GOTO
L02 - SGN MIN - SGN 0 CNS CHS *
0 WFM 1 WFM + 1 >WFM 1 LBL GOTO
L03 1 WFM 5 - SGN MIN - SGN 1 WFM
X<>Y - 2 WFM * 0 WFM 1 >WFM
.25 - SGN MIN - SGN 2 >WFM 1 WFM *
2CHS * 5 + 2 WFM * 1 WFM + 1 >WFM
.25 + SGN 1CHS VXPD MIN - SGN 2 >WFM
1 WFM * 2CHS * 5 - 2 WFM *
1 WFM + 6.283 * 2 >WFM
5040CHS / 2 WFM * 1 ENTER 120 / +
2 WFM * 2 WFM * 1 ENTER 6CHS / +
2 WFM * 2 WFM * 1 + 2 WFM *
STOP

```

2873-390

Figure 6-22. Program to display the sine of a waveform.

7854



GPIB Information

The 7854 (except Option ØD) is equipped with an interface which conforms to IEEE Standard 488-1978 Digital Interface for Programmable Instrumentation, commonly referred to as a General Purpose Interface Bus, or GPIB.

The GPIB allows permanent storage of 7854 programs, remote programming of the 7854, and data transfers to and from the 7854.

DESCRIPTION

The GPIB is an interface system using sixteen signal lines: eight data lines, three handshake lines, and five bus management lines. Information is transferred over the bus in a bit-parallel, byte-serial format using an asynchronous "handshake" procedure. This handshake allows communication between instruments with different transfer rates if they conform to the handshake state diagrams and other protocols defined in the IEEE standard. The data transfer rate is effectively limited by the slowest active instrument (talker or listener) on the bus. This ensures the accurate transfer of data to and from all active instruments.

The GPIB system can be connected in either a star or linear configuration, or a combination of both (see Fig. 7-1). To maintain the electrical characteristics of the bus, a device load must be connected for each two metres of cable, and at least half of the devices connected to the bus must be powered up.

A minimum GPIB system for the 7854 Oscilloscope would consist of the 7854 and a GPIB controller (e.g., a Tektronix 4050-series graphic system). The controller directs all command and data transfers on the GPIB.

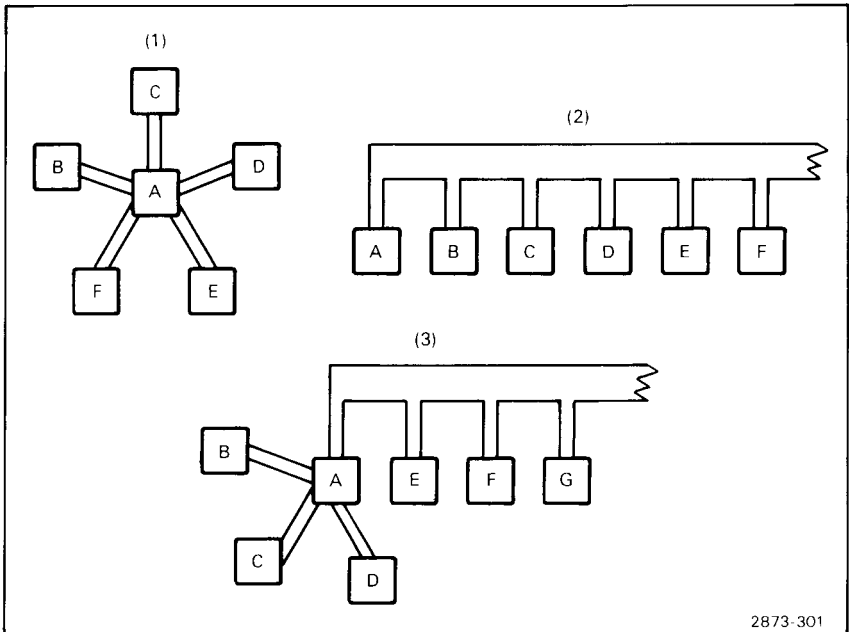

Figure 7-1. GPIB system configurations.

A larger GPIB system may consist of up to 15 instruments distributed over a total cable length of up to 20 metres. These instruments may include, in addition to the 7854 and controller, other talkers (e.g., counter, digital multimeter, etc.) and other listeners (e.g., line printer, tape drive, programmable signal generator, etc.).

A more detailed description of the actual operation of the GPIB interface may be found under GPIB Theory at the end of this section.

GPIB FUNCTIONS

The IEEE Standard 488-1978 defines the GPIB interface functions and the allowed subsets of those functions. The subsets that apply to the 7854 are listed in Table 7-1.

**TABLE 7-1
7854 GPIB Interface Functions**

Function	Subset	Capability
Source Handshake	SH1	Complete.
Acceptor Handshake	AH1	Complete.
Talker	T5	Complete. (no secondary address)
Listener	L3	Complete. (no secondary address)
Service Request	SR1	Complete.
Remote/Local	RL1	Complete.
Parallel Poll	PP0	None.
Device Clear	DC1	Complete.
Device Trigger	DT1	Complete.
Controller	C0	None.

ADDRESS SELECTION

The primary GPIB address of the 7854 is set by using the Address selection switches located on the rear panel of the 7854 (see Fig. 7-2). Actually, these switches set only the lower five bits of the address. The upper three bits are determined by the function (e.g., 001 for Listen Address, 010 for Talk Address). To set the primary GPIB address of the 7854, use a pen or other pointed object to set the binary equivalent of the desired primary address. Any primary address between and including 0 decimal (00000 binary) and 30 decimal (11110 binary) may be used. Do not set 31 decimal (11111 binary) as the primary address; 31 is reserved for use by the controller to "untalk" or "unlisten" a device. (Tektronix 4050-series graphic systems also reserve 0 decimal for another function.)

To set the 7854 for a primary GPIB address of 10 (decimal), set the address switches as shown below.

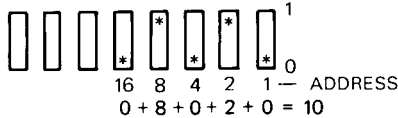

* INDICATES THIS END PRESSED

This setting results in My Listen Address (MLA) of 42 decimal (primary address + 32), and My Talk Address (MTA) of 74 decimal (primary address + 64).

To set the 7854 for GPIB operation (ON LINE) using a Line Feed (LF) character along with the EOI line asserted as a message terminator and TALK/LISTEN mode, set the left three switch sections as shown below.

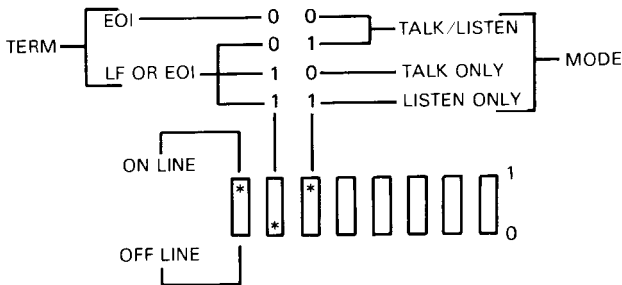

2873-300

Figure 7-2. Address and mode selection.

The remaining three switches select the operating mode of the 7854. The switch section to the left (ON LINE/OFF LINE) connects or disconnects the 7854 from the bus. (One device load is presented to the bus even when the 7854 is OFF LINE.) The other two switch sections set the message terminator or allow the 7854 to be used in a Talk Only or Listen Only mode. The message terminator is selected for compatibility with the GPIB controller being used. Refer to the controller manual for message termination requirements. (Set to EOI when using a Tektronix 4050-series graphic system as the GPIB controller.)

POWER-UP AND RESET STATES

POWER-UP STATE

When the 7854 is turned on, a self-test procedure is started to check the 7854 circuitry (see Power-Up Conditions in section 1). On completion of the self test, the 7854 asserts SRQ (Service Request) on the GPIB and sets the status byte to indicate the results of the self-test. (See Service Request in this section.) This SRQ can be cleared by a serial poll, or by executing any valid 7854 command.

RESET STATES

The following resets return the 7854 to the listed conditions.

Device Clear

The 7854 responds to either a DCL (Device Clear) or SDC (Selected Device Clear) message by executing a STOP command, aborting any input/output or waveform acquisition command in progress, and clearing all SRQ's. If an external input command (READX or >TEXT) is in progress, the partially filled data area is cleared (Ø WFM points = Ø, X-register = Ø, or any text input is deleted) and a warning is displayed. If an external output command (SAVE, SENDX, or TEXT) is in progress, it is terminated and a warning is displayed. (The READX, >TEXT, SAVE, SENDX, and TEXT commands are described under Commands in this section.)

Interface Clear

The IFC (Interface Clear) message interrupts any data input or output. If the 7854 is talking, it will continue from that point when it is again addressed as a talker. If the 7854 is listening, it will continue inputting data when it is again addressed as a listener.

Stop Key

If the 7854 is in talk-listen mode, pressing the 7854-keyboard STOP key will abort an I/O command (SAVE, TEXT, >TEXT, SENDX, READX) if the 7854 is not yet addressed as a talker or listener. If data transmission has already started, the STOP command is buffered until the I/O (Input/Output) command is finished.

If the 7854 is in talk-only mode or listen-only mode, the STOP command will abort an I/O command even if data transmission has started.

MESSAGES

All of the many possible messages that may be sent over the GPIB can be split into two major classifications; interface messages or device-dependent messages. Interface messages are sent by the GPIB controller to the other instruments on the bus to control the functions of each instrument's GPIB interface. Device-dependent messages (e.g., instrument commands, data, etc.) may be sent by any instrument on the bus, to any other instrument(s) on the bus. (See Fig. 7-3.)

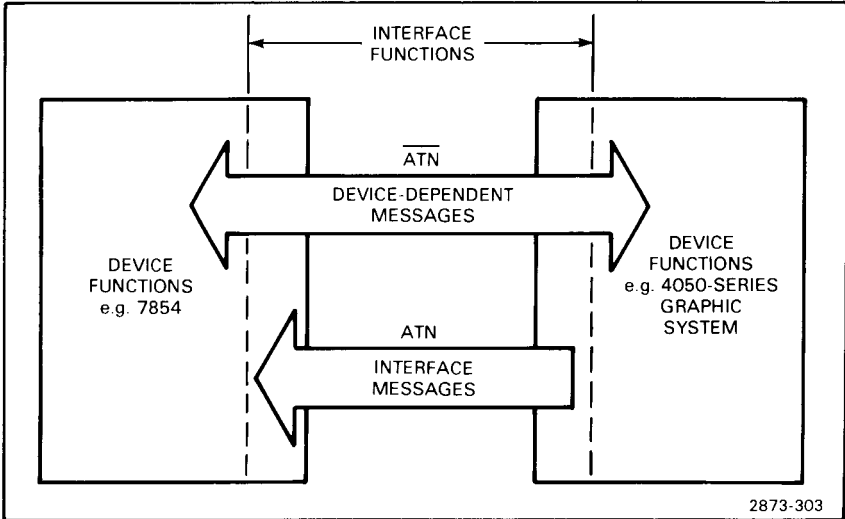

Figure 7-3. Device-dependent messages vs. interface messages.

GPIB INTERFACE MESSAGES

Interface messages are used by the controller to manage the bus (e.g., designate talkers and listeners, etc.). All instruments on the bus listen to every interface message.

The interface messages that constitute the controller's vocabulary are defined by the standard. They can be thought of as ASCII codes given a new meaning when sent by the controller with the Attention (ATN) line asserted.

Two of the interface messages are the talk and listen addresses. When a device sees its talk address (called My Talk Address or MTA) and ATN simultaneously, it must become a talker. When the controller removes ATN, the device begins the source handshake to transmit its data. Similarly, My Listen Address (MLA) and ATN tells a device to listen to the data sent by a talker.

The controller uses other kinds of interface messages for other tasks. One is the Serial Poll Enable command (SPE) used with the service request function. Suppose an instrument is designed to assert SRQ when it has acquired some data. The controller must poll the devices to find the interrupting device since any one (or more than one) can assert SRQ. To conduct the serial poll, the controller sends SPE, a universal command, then addresses each device in turn as a talker and reads a status byte from each. Any device asserting SRQ also asserts DIO7 of the status byte to tell the controller that it is actively requesting service. The remainder of the status byte tells the controller why it is requesting service. (See Service Request later in this section.)

The device trigger function uses an addressed command: Group Execute Trigger (GET). In the 7854, GET is equivalent to the RUN command.

The controller issues the Device Clear message (DCL) to initialize internal functions of devices on the bus. A universal command, DCL applies to all devices. Its effect on each instrument, however, is decided by the designer, who can choose to initialize any device function to any state that suits the purpose of the instrument. Its effect in the 7854 is described under Power-up And Reset States earlier in this section.

DEVICE-DEPENDENT MESSAGES

Device-dependent messages (e.g., 7854 commands, data, etc.) are transferred from any one instrument (talker) to one or more other instruments (listeners) on the bus. Device-dependent messages may effect the functions of the instruments (e.g., commands), but they do not directly effect the actual GPIB interface.

COMMANDS

Refer to Section 9, Command Language, for a complete listing of the 7854 commands with descriptions. All commands listed in section 9 can be sent through the GPIB to the 7854, which will react exactly as if the equivalent key(s) had been pressed on the Waveform Calculator or Measurement keyboards. Commands can be given to the 7854 from the Waveform Calculator keyboard, the Measurement keyboard, the GPIB, or any combination of the above. (Pressing any key on either 7854 keyboard generates a local rtl message.) Commands are executed in the order in which they are received by the 7854, regardless of the source of the command.

The 7854 keyboards can be disabled by setting the 7854 to remote-only mode. Remote-only mode prevents the accidental insertion of a command from the 7854 keyboard into a command string from the GPIB. (See Fig. 7-4 and 7-5 for sample programs.)

To send a command to the 7854 through the GPIB, send (to the 7854's address) the command mnemonic (or numeric command) as it appears on either of the 7854 keyboards (separating each mnemonic with a space).

```

100 REM * SUBROUTINE TO SET 7854 TO REMOTE-ONLY STATE
110 REM * 7854 IS GPIB DEVICE #10
120 REM *
130 WBYTE @ 17,42,63:
140 RETURN

      LINE 130 COMMENTS:
      17 = Send GPIB Local LOkout command (LLO)
      42 = Send 7854's listen address (device #+32)
      63 = Send GPIB UNListen command (UNL)
    
```

2873-304

Figure 7-4. Subroutine to set 7854 for remote-only operation (disable keyboards).

```

100 REM * SUBROUTINE TO SET 7854 TO NORMAL (REMOTE/LOCAL) STATE
110 REM * 7854 is DEVICE #10
120 REM *
130 WBYTE @ 42,1,63:
140 RETURN

      LINE 130 COMMENTS:
      42 = Send 7854's listen address (device #+32)
      1 = Send GPIB Go To Local command (GTL)
      63 = Send GPIB UNListen command (UNL)
    
```

2873-305

Figure 7-5. Subroutine to set 7854 for normal (remote/local) operation.

Multiple commands may be grouped as one message and sent in the same manner as a single command by separating each command (mnemonic or numeric) with a space.

Example: **1 0 2 4 >P/W AVG10 MAX SENDX**

NOTE

No more than ten (10) commands should be grouped following an I/O (Input/Output) command in the same message. The 7854 will buffer up to ten commands following an I/O command, and will execute them on completion of the I/O command. More than ten commands will cause the I/O command to be aborted and all commands following the I/O command to be ignored.

In addition to the standard commands, the 7854 has some commands for use with the GPIB only. These commands are listed below. (See Section 9, Command Language for detailed descriptions.)

Input/Output Commands

- SAVE** Outputs the contents of the program memory (from the edit prompt through end-of-program) to the GPIB.
- SENDX** Outputs the contents of the X register (constant or waveform data) to the GPIB.
- READX** Inputs a number (or waveform) from the GPIB and places it in the X register. (Waveform data is stored as Ø WFM.)
- >TEXT** Inputs up to 12 lines of text (4Ø char. max. each) from the GPIB for display on the 7854 crt (in STORED, SCOPE, or BOTH modes).
- TEXT** Outputs a copy of all 16 lines of currently displayed text to the GPIB (includes crt readout and blank lines).

Service Request Control

- RQS** Asserts Service Request (SRQ).
- RQSON / RQSOFF** Enables/disables all service request functions except power on.
- REMON / REMOFF** Enables/disables effect of RQS command.
- OPCON / OPCOFF** Enables/disables operation-complete service request.
- CERON / CEROFF** Enables/disables command-error service request.
- EXRON / EXROFF** Enables/disables execution-error service request.
- IOCON / IOCOFF** Enables/disables service request due to an Input/Output command being initiated.

NOTE

All service-request ON / OFF functions are set to ON condition at power-up.

Queries

- ERR? Outputs error status;
 ERR 00 if no error exists or
 ERR 01 if an error does exist.

- ID? Outputs a copy of the 7854 identification display to the GPIB.
 (ID TEK/7854,V79.I,XX.YY,ZK where XX is the ROM version,
 YY is the ROM revision, and Z is 2, 4, or 8, indicating the
 number of kilobytes of RAM installed.)

- SRQ? Outputs a copy of the bottom line of the calculator display.
 (SRQ XXXXXXXXXXXXXXXXXXXXXXXXXXXXXXXX where
 XXXX... is the bottom line of the display.)

NOTE

Do not send a query (ERR?, ID?, or SRQ?) to the 7854 following an I/O command (SAVE, SENDX, TEXT, >TEXT, or READX) until the I/O command is completed. A query will interrupt the I/O command and cause unpredictable I/O. (Use a serial poll to determine I/O-command status, if necessary. Status byte > 127 indicates I/O in progress.)

DATA TRANSFERS

Data that can be sent through the GPIB include programs, numeric values, waveforms, and text strings. The format of all data sent (output) by the 7854 is such that the same data can then be sent back (input) to the 7854 without any intermediate processing or loss of information. (The only exception to this is when the 7854 is set for EOI OR LF as the message terminator in the Talk-Listen mode and waveform data is being sent. In this case a carriage return and line feed separate the waveform preamble and curve data. The line feed must be deleted before sending the data back to the 7854.)

Programs

Refer to Programming in section 6 for detailed instructions for entering a program into the 7854 program memory. The GPIB allows permanent storage and rapid loading of 7854 programs.

NOTE

Initial program entry, editing, and testing should be done in the 7854, not in the controller. This eliminates the possibility of mnemonic spelling errors and other difficult-to-find problems in your program.

To send a program from the 7854 through the GPIB for permanent storage on tape or disk, simply move the edit prompt to the beginning of the program and issue the SAVE command. The program will be sent as one record, with the NEXT command and a carriage return appended to the end of each program line. The line numbers are removed from the program when it is sent and line labels will appear as LNN a b where a and b are single digit integers representing the label number.

These format changes allow the program to be easily entered into the 7854 program memory, and the carriage returns allow the controller to transfer the program (line-by-line) to tape or disk. (See Fig. 7-6 for sample program.)

```

100 REM * TRANSFER 7854 PROGRAM TO 4050 TAPE FILE
110 REM * 7854 IS GPIB DEVICE #10
120 REM *
130 REM * STORE PROGRAM ON FILE NUMBER: F
140 REM *
150 ON SRQ THEN 260
160 S=0
170 PRINT @10:"EXECUTE 0 GOTO PROGRAM SAVE"
180 IF S<>208 THEN 180
190 FIND F
200 ON EOI THEN 240
210 INPUT @10:Ls
220 PRINT @33:Ls
230 GO TO 200
240 PRINT @33:Ls
250 END
260 POLL D,S;10
270 RETURN

```

LINE BY LINE COMMENTS:

```

150 Enable SRQ interrupt handler at 260
160 Clear status flag
170 Command 7854 to send entire program
180 Wait for 'SAVE' service request status byte
190 Position 4050 tape to file F
200 Enable EOI interrupt handler at 240
210 Input next line of program from 7854
220 Save line of program on tape
230 Continue until EOI
240 On EOI save last line of program on tape
250 Stop
260 Serial poll 7854; S = status byte
270 Return from SRQ interrupt handler

```

2873-306

Figure 7-6. Transfer 7854 program to controller tape file (SAVE sample program).

To copy a program back to the 7854 program memory, first execute the PROG command to enter the Program Entry mode. Then send the stored program to the 7854's address. When the program has been copied by the 7854, it may be modified and/or executed in the normal manner using the 7854 keyboard. (See Fig. 7-7 for sample program.)

```

100 REM *TRANSFER PROGRAM FROM 4050 TAPE FILE TO 7854
110 REM *7854 IS GPIB DEVICE #10
120 REM *
130 REM *LOAD PROGRAM FROM FILE NUMBER: F
140 REM *
150 ON SRQ THEN 250
160 S=0
170 PRINT @10:"PROGRAM CLP NEXT"
180 IF S<>66 THEN 180
190 FIND F
200 ON EOF (0) THEN 240
210 INPUT @33:L$
220 PRINT @10:L$
230 GO TO 210
240 END
250 POLL D,S:10
260 RETURN

```

LINE BY LINE COMMENTS:

```

150 Enable SRQ interrupt handler at 250
160 Clear status byte
170 Command 7854 accept a new program
180 Wait for operation complete status byte
190 Position 4050 tape to file F
200 Enable end-of-file interrupt handler at 240
210 Input next line of program from tape file
220 Send line of program to 7854
230 Continue until end-of-file
240 Stop
250 Serial poll 7854; S = status byte
260 Return from SRQ interrupt handler

```

2873-307

Figure 7-7. Transfer 7854 program from controller tape file to 7854.

Numeric Values

Numeric values (constants) can be transferred from the 7854 over the GPIB by placing the value in the X register and then executing the SENDX command. (See Fig. 7-8 for sample program.)

Numeric values can be transferred back to the 7854 and placed in the X register by executing the READX command and then sending the number to the 7854 over the GPIB. (See Fig. 7-9 for sample program.)

```

100 REM *TRANSFER CONSTANT (MAX) FROM 7854 TO 4050 VARIABLE
110 REM * 7854 IS GPIB DEVICE #10
120 REM *
130 REM *INPUT CONSTANT INTO VARIABLE: M
140 REM *
150 ON SRQ THEN 210
160 S=0
170 PRINT @10:"MAX SENDX"
180 IF S<>210 THEN 180
190 INPUT @10:M
200 END
210 POLL D,S;10
220 RETURN

```

LINE BY LINE COMMENTS:

```

150 Enable SRQ interrupt handler at line 210
160 Clear status flag
170 Command 7854 to send the 'MAX' value
180 Wait for 'SENDX' service request status byte
190 Input constant (MAX) from 7854 into variable M
200 Stop
210 Serial poll 7854; S = status byte
220 Return from SRQ interrupt handler

```

2873-308

Figure 7-8. SENDX sample program.

```

100 REM *TRANSFER 4050 VARIABLE TO 7854'S X REGISTER
110 REM * 7854 IS GPIB DEVICE #10
120 REM *
130 REM *OUTPUT CONSTANT FROM VARIABLE: M
140 REM *
150 ON SRQ THEN 210
160 S=0
170 PRINT @10:"READX"
180 IF S<>211 THEN 180
190 PRINT @10:M
200 END
210 POLL D,S;10
220 RETURN

```

LINE BY LINE COMMENTS:

```

150 Enable SRQ interrupt handler at 210
160 Clear status flag
170 Command 7854 to accept data
180 Wait for 'READX' service request status byte
190 Output variable M to 7854
200 Stop
210 Serial poll 7854; S = status byte
220 Return from SRQ interrupt handler

```

2873-309

Figure 7-9. READX sample program.

Waveforms

Waveform data is sent as one message; the waveform preamble, a separator, and the curve data. The waveform preamble contains information such as points/waveform, volts/division, time/division, offset voltage, etc. The separator is either a carriage return (Message Terminator set to EOI) or a carriage return and line feed (Message Terminator set to LF OR EOI). The curve data contains the actual vertical ordinate value (in divisions) of each point of the waveform relative to the craticule.

Waveform Preamble: A typical waveform preamble, as sent by the 7854, is shown below:

```
WFMPRE ENCDG:ASC,NR.PT:512,PT.FMT:Y,XZERO:0,XINCR:9.766E-06,  
XUNIT:S,YZERO:2.704,YMULT:1,YUNIT:V;
```

The abbreviations in the waveform preamble are as follows:

WFMPRE ¹	waveform preamble (header)
ENCDG:ASC ¹	curve data encoded ASCII decimal
NR.PT:(P/W)	number of points/waveform
PT.FMT:Y ¹	point format (curve data in vert. div.)
XZERO:0 ¹	no horizontal offset
XINCR:[10 * HSCL / (P/W)]	horizontal increment between points
XUNIT:S	horizontal scale factor units (S=seconds)
YZERO:[-(VSCL * VZR)]	vertical zero offset
YMULT:(VSCL)	vertical scale factor
YUNIT:V	vertical scale factor units (V=volts)

¹Fixed value, cannot be changed.

Curve Data: A typical curve data (partial) is shown below:

```
CURVE 1.3779, 1.3777, 1.3778, 1.3777, ..., 1.3777, -2.6953, -2.6955, -2.6954,  
-2.6955
```

The curve data consists of the header (CURVE) followed by one ASCII coded decimal number for each point of the waveform. Each number is separated by commas and represents the vertical distance of that point from the center horizontal graticule line, measured in graticule divisions (negative if below center).

To send (output) a stored waveform (or more properly, send data representing a waveform) from the 7854 through the GPIB, the waveform must be placed in the X register. The waveform data can then be sent by giving the SENDX command. (See Fig. 7-10 and 7-11 for sample programs.)

To copy a waveform back into the 7854, execute the READX command and send the waveform preamble and curve data to the 7854's address. The waveform preamble and curve data must be sent as a single message with no line feed between the two strings. The waveform will become the operational waveform (Ø WFM) in the 7854 and can then be copied to another waveform memory address if desired. (See Fig. 7-12 and 7-13 for sample programs.)

```

100 REM *TRANSFER WAVEFORM #Ø FROM 7854 TO 405Ø ASCII STRINGS
120 REM *7854 IS GPIB DEVICE #1Ø
130 REM *
140 REM *INPUT WAVEFORM PREAMBLE INTO ASCII STRING: P$
150 REM *INPUT WAVEFORM CURVE INTO ASCII STRING: W$
160 REM *
170 DIM P$(200),W$(8200)
180 ON SRQ THEN 250
190 S=Ø
200 PRINT @1Ø:"Ø WFM SENDX"
210 IF S<>21Ø THEN 21Ø
220 INPUT @1Ø:P$
230 INPUT @1Ø:W$
240 END
250 POLL D,S;1Ø
260 RETURN

```

LINE BY LINE COMMENTS:

```

170 Dimension ASCII strings P$ & W$
180 Enable SRQ interrupt handler at line 250
190 Clear status flag
200 Command 7854 to send waveform #Ø
210 Wait for 'SENDX' service request status byte
220 Input waveform preamble from 7854 to P$
230 Input waveform curve from 7854 into W$
240 Stop
250 Serial poll 7854; S = status byte
260 Return from SRQ interrupt handler

```

2873-310

Figure 7-10. Waveform transfer from 7854 to controller (ASCII strings).

```

100 REM * TRANSFER WAVEFORM #0 FROM 7854 TO 4050 VARIABLES & ARRAY
110 REM * 7854 IS GPIB DEVICE #10
120 REM *
130 REM * INPUT WAVEFORM PREAMBLE INTO VARIABLES: N,Z1,X,Z2,Y
140 REM *      N = POINTS / WAVEFORM
150 REM *      Z1 = HORIZONTAL ZERO
160 REM *      X = HORIZONTAL INCREMENT BETWEEN POINTS
170 REM *      Z2 = VERTICAL ZERO
180 REM *      Y = VERTICAL SCALE FACTOR
190 REM * INPUT WAVEFORM CURVE INTO ARRAY: W
200 REM *
210 ON SRQ THEN 300
220 S = 0
230 PRINT @10: "0 WFM SENDX"
240 IF S = 210 THEN 240
250 INPUT @10:N,Z1,X,Z2,Y
260 DELETE W
270 DIM W(N)
280 INPUT @10:W
290 END
300 POLL D,S:10
310 RETURN
      LINE BY LINE COMMENTS:
      210 Enable SRQ interrupt handler at line 300
      220 Clear status flag
      230 Command 7854 to send waveform #0
      240 Wait for 'SENDX' service request status byte
      250 Input waveform preamble arguments into N,Z1,X,Z2,Y
      260 Delete Array W
      270 Dimension array W to size N (N Points/Waveform)
      280 Input waveform curve into array W
      290 Stop
      300 Serial poll 7854; S = status byte
      310 Return from SRQ interrupt handler

```

2873 311A

Figure 7-11. Waveform transfer from 7854 to controller (numeric array).

```

100 REM * TRANSFER 4050 ASCII STRINGS TO 7854'S WAVEFORM #0
110 REM * 7854 IS GPIB DEVICE #10
120 REM * OUTPUT WAVEFORM PREAMBLE FROM ASCII STRING: P$
140 REM * OUTPUT WAVEFORM CURVE FROM ASCII STRING: W$
150 REM *
160 ON SRQ THEN 220
170 S=0
180 PRINT @10: "READX"
190 IF S = 211 THEN 190
200 PRINT @10:P$:W$
210 END
220 POLL D,S:10
230 RETURN
      LINE BY LINE COMMENTS:
      160 Enable SRQ interrupt handler at 220
      170 Clear status flag
      180 Command 7854 to accept data
      190 Wait for 'READX' service request status byte
      200 Output waveform from P$ & W$ to 7854
      210 Stop
      220 Serial poll 7854; S = status byte
      230 Return from SRQ interrupt handler

```

2873 312

Figure 7-12. Waveform transfer from controller (ASCII strings) to 7854.

```

100 REM *TRANSFER 4051 VARIABLES AND ARRAY TO 7854's WAVEFORM #0
110 REM *
120 REM *OUTPUT WAVEFORM PREAMBLE FROM VARIABLES: N,Z1,X,Z2,Y
130 REM *      N = POINTS/WAVEFORM
140 REM *      Z1 = HORIZONTAL ZERO
150 REM *      X = HORIZONTAL INCREMENT BETWEEN POINTS
160 REM *      Z2 = VERTICAL ZERO
170 REM *      Y = VERTICAL SCALE FACTOR
180 REM *OUTPUT WAVEFORM CURVE FROM ARRAY: W
190 REM *
200 DIM P$(200)
210 ON SRQ THEN 460
220 REM * BUILD WAVEFORM PREAMBLE
230 P$="WFMPRE ENCDG:ASC,NR.PT:"
240 T$=STR(N)
250 P$=P$&T$
260 P$=P$&" PT.FMT:Y,XZERO:"
270 T$=STR(Z1)
280 P$=P$&T$
290 P$=P$&" XINCR:"
300 T$=STR(X)
310 P$=P$&T$
320 P$=P$&" XUNIT:S,YZERO:"
330 T$=STR(Z2)
340 P$=P$&T$
350 P$=P$&" YMULT:"
360 T$=STR(Y)
370 P$=P$&T$
380 P$=P$&" YUNIT:V;CURVE "
390 S=0
400 PRINT @10:"READX"
410 IF S<>211 THEN 410
420 REM * THE COMMA(,) BETWEEN P$ AND W IN LINE 440 IS REQUIRED,
430 REM * A SEMICOLON (;) WILL NOT WORK
440 PRINT @10:P$,W
450 END
460 POLL D,S:10
470 RETURN

```

LINE BY LINE COMMENTS:

```

200 Dimension ASCII string P$
210 Enable SRQ interrupt handler at line 460
230 through 380:
    Build waveform preamble in P$
390 Clear status flag
400 Command 7854 to accept data
410 Wait for 'READX' service request status byte
440 Send waveform to 7854
450 Stop
460 Serial poll 7854; S = status byte
470 Return from SRQ interrupt handler

```

2983-313

Figure 7-13. Waveform transfer from controller (numeric array) to 7854.

Text

Up to 12 lines of text (40 characters max. each) may be sent to the 7854 to be displayed on the crt along with the waveform(s). This text can include operator prompts, additional information for documenting photographs, or any comments the programmer may wish to display on the 7854 crt.

To send text to the 7854, give the >TEXT command, followed by a single string of text which has carriage return codes (ASCII decimal 13) inserted at the line breaks. The text display remains until another >TEXT command is given, a crt display command (STORED, SCOPE, **BOTH**, or ID) is given, or the 7854 is put into Program mode. (See Fig. 7-14 for sample program.)

The text to be displayed may include characters not found on the ASCII code chart (located at the end of this section). Table 7-2 lists the additional special characters which may be displayed on the 7854 crt and the codes used to represent them.

TABLE 7-2
Special Character Codes

Special Character	ASCII Code	(decimal)	Keystrokes
β (cap. beta)	SOH	1	ESC CTRL-A
γ (gama)	STX	2	ESC CTRL-B
η (eta)	EOT	4	ESC CTRL-D
□ (box)	ENQ	5	ESC CTRL-E
▭ (rectangle)	ACK	6	ESC CTRL-F
δ (delta)	BEL	7	ESC CTRL-G
° (degree)	BS	8	ESC CTRL-H
α (alpha)	HT	9	ESC CTRL-I
Δ (cap. delta)	SØ	14	ESC CTRL-N
π (pi)	SI	15	ESC CTRL-O
ρ (rho)	DLE	16	ESC CTRL-P
σ (sigma)	DC1	17	ESC CTRL-Q
τ (tau)	DC2	18	ESC CTRL-R

TABLE 7-2 (CONT)
Special Character Codes

Special Character	ASCII Code	(decimal)	Keystrokes
μ (mu or micro)	DC3	19	ESC CTRL-S
ν (nu)	DC4	20	ESC CTRL-T
Ω (cap. omega)	SYN	22	ESC CTRL-V
ω (omega)	ETB	23	ESC CTRL-W
\surd (square root)	EM	25	ESC CTRL-Y
- (right arrow)	SUB	26	ESC CTRL-Z
- (left arrow)	ESC	27	ESC CTRL-[
↓ (down arrow)	FS	28	ESC CTRL-\
↑ (up arrow)	GS	29	ESC CTRL-]

For example, to display a μ symbol, send ESC followed by CTRL-S or the decimal ASCII codes 27, 19.

All 16 lines of text being displayed on the 7854 can be sent back to the controller for editing or inspection by giving the TEXT command. This text includes all currently displayed text previously sent to the 7854 via the >TEXT command (lines 3 through 14), and all crt-readout text (lines 1-2 and 15-16). The TEXT command is executable in SCOPE, STORED, or **BOTH** modes only. (See Fig. 7-15 for sample program.)

SERVICE REQUEST

The service request function allows the 7854 to keep the GPIB controller informed of its status. This is done by asserting SRQ (Service Request) and then sending a status byte to the controller when polled. The status byte is an eight-bit binary number which represents the status of the 7854. Most of the SRQ's can be disabled if desired; however, the status byte is still available. The only SRQ that cannot be disabled is the Power-On SRQ which is asserted on completion of the 7854 self test (if the 7854 is ON LINE when power is applied). Any service request can be cleared by performing a serial poll of the 7854.

```

100 REM * TRANSFER TEXT FROM 4050 TO 7854 CRT
110 REM * 7854 IS GPIB DEVICE #10
120 REM *
130 REM * BUILD TEXT IN STRING: Ts
140 REM *
150 ON SRQ THEN 340
160 DIM Ts(12*41)
170 PRINT "INPUT TEXT AS IT IS TO BE DISPLAYED ON 7854"
180 PRINT "J SPACE RETURN FOR A BLANK LINE"
190 PRINT "RETURN ONLY TO END INPUTJ"
200 Ts=""
210 Cs=CHR(13)
220 FOR I=1 TO 12
230 PRINT "----";
240 INPUT Ls
250 IF LEN(Ls)<1 THEN 290
260 Ts=Ts&Ls
270 Ts=Ts&Cs
280 NEXT I
290 S=0
300 PRINT @10:"EXECUTE TEXT"
310 IF S=213 THEN 310
320 PRINT @10:Ts
330 END
340 POLL D,S:10
350 RETURN

```

LINE BY LINE COMMENTS:

```

150 Enable SRQ interrupt handler at line 340
160 Dimension ASCII string Ts (12 lines of 41 characters)
170 through 190:
    Prompt 4050 user to input text
200 Null Ts
210 Define Cs as <CARRIAGE RETURN>
220 Loop to accept maximum of 12 lines
230 Issue line input prompt
240 Input next line of text
250 If only <CARRIAGE RETURN> then done inputting
260 Concatenate text onto Ts
270 Concatenate a <CARRIAGE RETURN> after each line
280 Continue accepting text
290 Clear status flag
300 Command 7854 to accept text for display
310 Wait for 'TEXT' status byte
320 Send text to 7854
330 Stop
340 Serial poll 7854; S = status byte
350 Return from SRQ interrupt handler

```

2873-314A

Figure 7-14. TEXT sample program.

```

100 REM * TRANSFER TEXT FROM 7854 DISPLAY TO 4050
110 REM *
120 ON SRQ THEN 280
130 PAGE
140 PRINT @10:"SRQ?"
150 INPUT @10:S$
160 S=POS(S$,"SRQ ",1)
170 S$=SEG(S$,S+4,LEN(S$)-S-3)
180 S=0
190 PRINT @10:"TEXT"
200 IF S<>212 THEN 200
210 FOR I=1 TO 15
220 INPUT @10:L$
230 PRINT L$
240 NEXT I
250 PRINT S$
260 INPUT @10:L$
270 END
280 POLL D,S;10
290 RETURN

```

LINE BY LINE COMMENTS:

```

120 Enable SRQ interrupt handler at line 280
130 Page 4050 crt screen
140 Use 'SRQ?' querie to get line #16 of 7854's readout
150 Input line #16
160 Find position of substrng 'SRQ' in response
170 Remove querie header
180 Clear status flag
190 Command 7854 to send readout
200 Wait for 'TEXT' service request status byte
210 Loop to input first 15 lines of text
220 Input line of text
230 Display line of text on 4050
240 Continue inputting first 15 lines
250 Use 16th line from 'SRQ?' querie
260 Clear last line of text from 7854
270 Stop
280 Serial poll 7854: S = status byte
290 Return from SRQ interrupt handler

```

2873-315

Figure 7-15. TEXT sample program.

Status Bytes

The status bytes which are sent by the 7854 and their meanings are listed in Table 7-3.

TABLE 7-3
7854 Status Bytes

Condition	Status Byte 8765 4321	Decimal Equivalent
Normal	000X 0000 ^a	(0,16)
Ext. command group complete ¹	0X00 0010 ^b	(2,66)
End of program ¹	0X00 0010 ^b	(2,66)
Execution error ²	0X10 0010 ^b	(34,98)
External command error ³	0X10 0001 ^b	(33,97)
Power On	010X 0001 ^a	(65,81)
Power on check failure	011X 0011 ^a	(99,115)
RQS command executed ⁴	0101 0000	(80)
SAVE command initiated ⁵	1X01 0000 ^b	(144,208)
SENDX command initiated ⁵	1X01 0010 ^b	(146,210)
READX command initiated ⁵	1X01 0011 ^b	(147,211)
TEXT command initiated ⁵	1X01 0100 ^b	(148,212)
>TEXT command initiated ⁵	1X01 0101 ^b	(149,213)

¹OPCOFF command will disable this service request.

²EXROFF command will disable this service request.

³CEROFF command will disable this service request.

⁴REMOFF command will disable this service request.

⁵IOCOFF command will disable this service request.

^abit 5 true (1) indicates busy condition.

^bbit 7 true (1) indicates active service request.

NOTE

The RQSOFF command will disable all SRQ's except power on. Therefore, for any other service request to function, the RQSON command must be given, along with the command to enable that service request.

Polling

A serial poll allows the GPIB controller to check the status of any or all instruments on the bus. When the 7854 is polled, it sends the appropriate status byte and (if the 7854 was asserting SRQ) clears its service request. The status byte can then be used to initiate corrective action, proceed with the program, or send a message to the operator. (See Fig. 7-16 for sample program.)

```

100  REM *SERIAL POLL SUBROUTINE #1
110  REM *
120  POLL D,S;10
130  RETURN
140  REM *SERIAL POLL SUBROUTINE #2
150  REM *
160  WBYTE @95,63,24,74:
170  RBYTE S
180  WBYTE @95,25:
190  RETURN

      LINE BY LINE COMMENTS:
100  Use 4050 POLL command if 7854 is requesting service
120  S = status byte
130  End of subroutine #1
140  Use 4050 WBYTE and RBYTE commands if 7854 is not
      requesting service
160  95 = Send GPIB UNTalk command (UNT)
      63 = Send GPIB UNListen command (UNL)
      24 = Send GPIB Serial Poll Enable command (SPE)
      74 = Send 7854's talk address
170  Input status byte (S)
180  95 = Send GPIB UNTalk command (UNT)
      25 = Send GPIB Serial Poll Disable command (SPD)
190  End of subroutine #2
    
```

2873-316

Figure 7-16. Serial-poll sample subroutines.

GPIB THEORY

The IEEE Standard 488-1978 is a complete description of the GPIB interface. The following brief description is included here to, hopefully, simplify the standard's technical descriptions and state diagrams, and make them a little easier to understand. This description should be read in conjunction with the IEEE standard.

GPIB SIGNAL LINES

The GPIB contains three groups of signal lines: data, handshake, and control.

The eight data lines, DIO1 through DIO8, are used to carry both interface messages and device-dependent messages.

The asynchronous, three-wire handshake is controlled by these lines:

DAV (Data Valid)—asserted by the transmitting device.

NRFD (Not Ready For Data) and NDAC (Not Data Accepted)—asserted by the receiving device.

The five interface control lines are used for the following functions:

ATN (Attention)—specifies how data on the DIO lines is to be interpreted; as interface messages when asserted; as device dependent messages when unasserted.

IFC (Interface Clear)—is used to initialize the interface functions of all instruments and return control to the system controller.

SRQ (Service Request) is used to request service from the controller.

REN (Remote Enable)—allows remote control of devices on this bus.

EOI (End Or Identify)—indicates the last byte of a message.

See IEEE Standard 488-1978, Standard Digital Interface for Programmable Instrumentation, for full definitions of these lines and the protocol for their use.

THE HANDSHAKE

The data and handshake lines are used for the source and acceptor handshake. Actually, they are two parts of the same handshake. Fig. 7-17 shows the states of these lines as they are set by a talker using the source handshake and a listener using the acceptor handshake. Note that the timing diagram relates the electrical signals on the bus to the states of the source and acceptor handshakes. By looking at both, it may be easier to grasp the sequence of the interlocked handshakes than it is to absorb, by themselves, the state diagrams in the standard.

1. To begin, the source goes to the Source Generate State (SGNS). In this state, the source is not asserting a data byte on the data lines or Data Valid (DAV). When no bus driver is asserting a line, the line rises to a high level (\emptyset) set by the bus terminating network. The acceptors are in the Acceptor Not Ready State (ANRS), asserting both Not Ready For Data (NRFD) and Not Data Accepted (NDAC). In this condition, NRFD and NDAC are both low (asserted).
2. The source sets the data byte on the data lines and enters the Source Delay State (SDYS). If this is the last data byte in the message, the source asserts the End Or Identify (EOI) line at the same time. The source waits for the data to settle on the lines and for all acceptors to reach the Acceptor Ready State (ACRS).
3. Each acceptor says, "I'm ready" by releasing Not Ready For Data (NRFD) to move to the Acceptor Ready State (ACRS). This is one of the points in the handshake designed to accommodate slower listeners. Any acceptor can delay the source handshake by asserting NRFD.

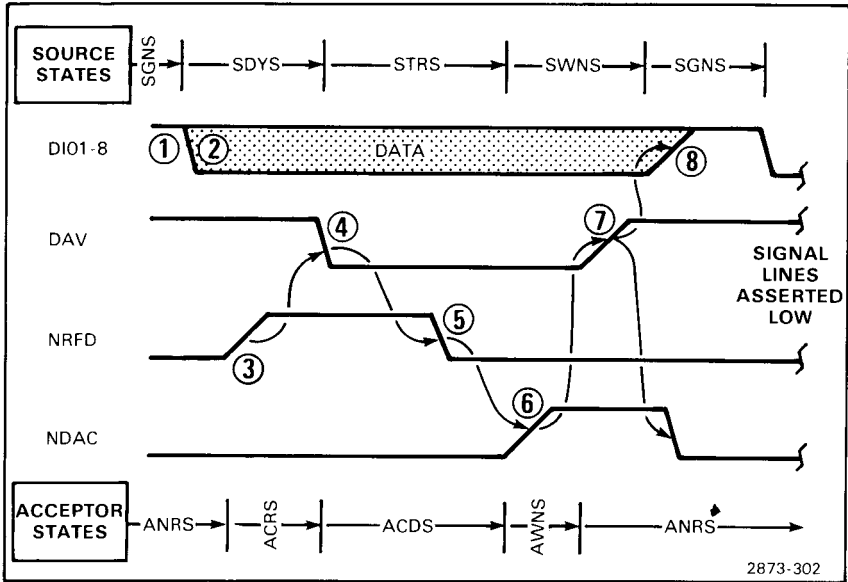

Figure 7-17. Source and acceptor handshake sequence.

4. When the source sees Not Ready For Data (NRFD) high, the Source Transfer State (STRS) is entered by validating the data with Data Valid (DAV). The source then waits for the data to be accepted.
5. When the receiving devices see DAV true, they go to the Accept Data State (ACDS). Each device asserts Not Ready For Data (NRFD) because it is busy with the current data byte and is not ready for another.
6. As each device accepts the data, the device releases Not Data Accepted (NDAC) to move from the Accept Data State (ACDS) to the Acceptor Wait for New cycle State (AWNS). Again, all receivers must release the Not Data Accepted (NDAC) line for the source to see a high level.

When the source sees NDAC high (all listeners have accepted the data), the Source Wait for New cycle State (SWNS) is entered.

7. In the SWNS, the source unasserts Data Valid (DAV). This causes the acceptors to proceed to the Acceptor Not Ready State (ANRS), their initial state in the handshake. In ANRS, they assert Not Data Accepted (NDAC).
8. The source continues to the Source Generate State (SGNS), its initial state in the handshake, to prepare a new byte for transmission.

ASCII & IEEE 488 (GPIB) CODE CHART

BITS		0 0 0		0 0 1		0 1 0		0 1 1		1 0 0		1 0 1		1 1 0		1 1 1			
B7	B6	CONTROL				NUMBERS SYMBOLS				UPPER CASE				LOWER CASE					
B5	B4	B3	B2	B1															
0	0	0	0	0	NUL	20	DLE	40	SP	60	0	100	@	120	P	140	'	160	p
0	0	0	1	0	10	16	20	32	30	46	40	64	50	80	60	96	70	112	
1	0	0	0	1	GTL	21	LLO	41	!	61	1	101	A	121	Q	141	a	161	q
1	0	0	1	1	11	17	21	33	31	49	41	65	51	81	61	97	71	113	
2	0	0	1	0	22	DC2	42	"	62	2	B	102	R	122	R	142	b	162	r
2	0	1	0	0	2	12	18	34	32	50	42	66	52	82	62	98	72	114	
2	0	1	1	0	23	DC3	43	#	63	3	C	103	S	123	S	143	c	163	s
3	0	0	1	1	3	13	19	35	33	51	43	67	53	83	63	99	73	115	
3	0	1	0	0	SDC	24	DCL	44	\$	64	4	104	D	124	T	144	d	164	t
3	0	1	1	0	4	14	20	36	34	52	44	68	54	84	64	100	74	116	
4	0	0	1	1	PPC	25	PPU	45	%	65	5	105	E	125	U	145	e	165	u
4	0	1	0	1	5	15	21	37	35	53	45	69	55	85	65	101	75	117	
4	0	1	1	0	26	SYN	46	&	66	6	F	106	V	126	V	146	f	166	v
4	0	1	1	1	6	16	22	38	36	54	46	70	56	86	66	102	76	118	
5	0	0	1	1	27	ETB	47	'	67	7	G	107	W	127	W	147	g	167	w
5	0	1	1	1	7	17	23	39	37	55	47	71	57	87	67	103	77	119	
6	0	0	0	0	10	GET	30	SPE	50	8	H	110	X	130	X	150	h	170	x
6	0	0	1	0	8	18	24	40	38	56	48	72	58	88	68	104	78	120	
6	0	0	1	1	11	TCT	31	SPD	51	9	I	111	Y	131	Y	151	i	171	y
6	0	1	0	1	9	19	25	41	39	57	49	73	59	89	69	105	79	121	
7	0	0	1	0	12	LF	SUB	52	*	72	:	J	Z	132	Z	152	j	172	z
7	0	1	0	0	A	10	1A	26	2A	42	3A	58	4A	74	5A	90	6A	7A	122
7	0	1	1	0	13	VT	ESC	53	+	73	;	K	[133	[153	k	173	{
7	0	1	1	1	B	11	1B	27	2B	43	3B	59	4B	75	5B	91	6B	7B	123
8	0	0	0	0	14	FF	FS	54	,	74	<	L	\	134	\	154	l	174	!
8	0	0	1	0	C	12	1C	28	2C	44	3C	60	4C	76	5C	92	6C	7C	124
8	0	0	1	1	15	CR	GS	55	-	75	=	M]	135]	155	m	175	}
8	0	1	0	1	D	13	1D	29	2D	45	3D	61	4D	77	5D	93	6D	7D	125
8	0	1	1	0	16	SO	RS	56	.	76	>	N	^	136	^	156	n	176	~
8	0	1	1	1	E	14	1E	30	2E	46	3E	62	4E	78	5E	94	6E	7E	126
9	0	0	0	0	17	SI	US	57	/	77	?	O	_	137	_	157	o	177	RUBOUT (DEL)
9	0	0	1	0	F	15	1F	31	2F	47	3F	63	4F	79	5F	95	6F	7F	127

KEY

octal	25	PPU	GPIB code
	NAK		ASCII character
hex	15	21	decimal

7854

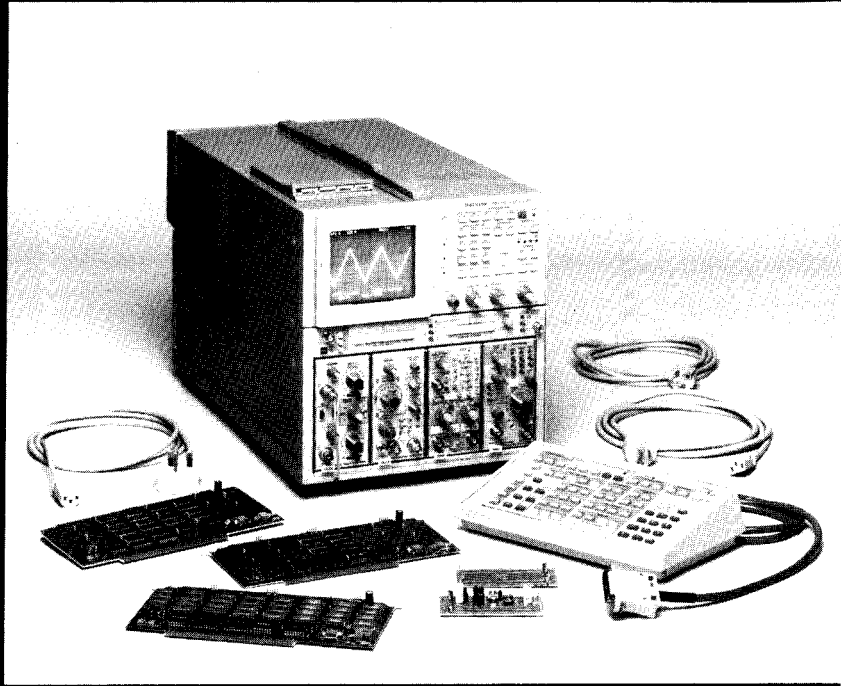

Instrument Options

Your 7854 Oscilloscope may be equipped with one or more options. This section includes a brief description of each option, and an Option Information Locator table. The Option Information Locator table lists all the options and tells where they are mentioned in this manual. For further information about options, see your Tektronix Products catalog or contact your Tektronix Field Office.

OPTION 02

Option 02 provides X-Y mode phase correction of the real-time signals. A horizontal delay line and compensation network equalizes the signal delay between either vertical compartment and the horizontal deflection system. With this network installed and activated, the phase shift between the vertical and horizontal systems is adjustable to less than 2° from dc to one megahertz.

OPTION 03

With Option 03 installed, the instrument will meet the EMC (electromagnetic compatibility) specifications given in section 2.

OPTION 78

Replaces standard crt phosphor with P11.

OPTION 0D

Deletes the Waveform Calculator and GPIB facilities by removing 2000 words of memory, and replacing the rear-panel GPIB connector and ADDRESS SELECTION switches with a blank panel. Operation of the instrument will not change except that the front-panel RQS key and I/O, SRQ, and REMOTE ONLY indicators are inoperative. All access to the Waveform Calculator commands is denied when the 2K of memory is removed.

OPTION 2D¹

An additional 4096 words of memory are added with Option 2D to expand the program memory, waveform memory, and constant registers. Program memory is increased to a maximum of 2000 commands, waveform memory is increased to 5120 waveform points, and the constant registers are increased to 100.

OPTION A1

The standard power cord is replaced with the Universal European 220-volt type power cord (Tektronix Part 161-0066-09).

OPTION A2

The standard power cord is replaced with the UK240-volt type power cord (Tektronix Part 161-0066-10).

OPTION A3

The standard power cord is replaced with the Australian 240-volt type power cord (Tektronix Part 161-0066-11).

OPTION A4

The standard power cord is replaced with the North American 240-volt type power cord (Tektronix Part 161-0066-12).

¹ Applies only to instruments with serial numbers below B085121. For instruments with serial number B085121 and above, features previously provided by Option 2D are standard.

OPTION 1S

Option 1S includes a currently applicable version of the Diagnostic Memory Card (Tektronix Part 067-0961-XX) with the 7854 Oscilloscope. This card is part of the digital servicing package and is not required for instrument operation or understanding.

OPTION 2S

Option 2S includes a currently applicable version of the Signature Tables (Tektronix Part 070-2972-XX) with the 7854 Oscilloscope. The Signature Tables are required for signature analysis troubleshooting, but not for instrument operation or understanding.

INSTRUMENT OPTION IDENTIFICATION

7854 Oscilloscopes with one or more options have a tag attached to the rear-panel of the mainframe to identify each included option (02, 03, 78, 0D, 2D, A1, A2, A3, or A4). The tag(s) will be located as shown in Figure 8-1. Instruments with Options 1S or 2S will not have any identification tag since these options are not part of the 7854 Oscilloscope.

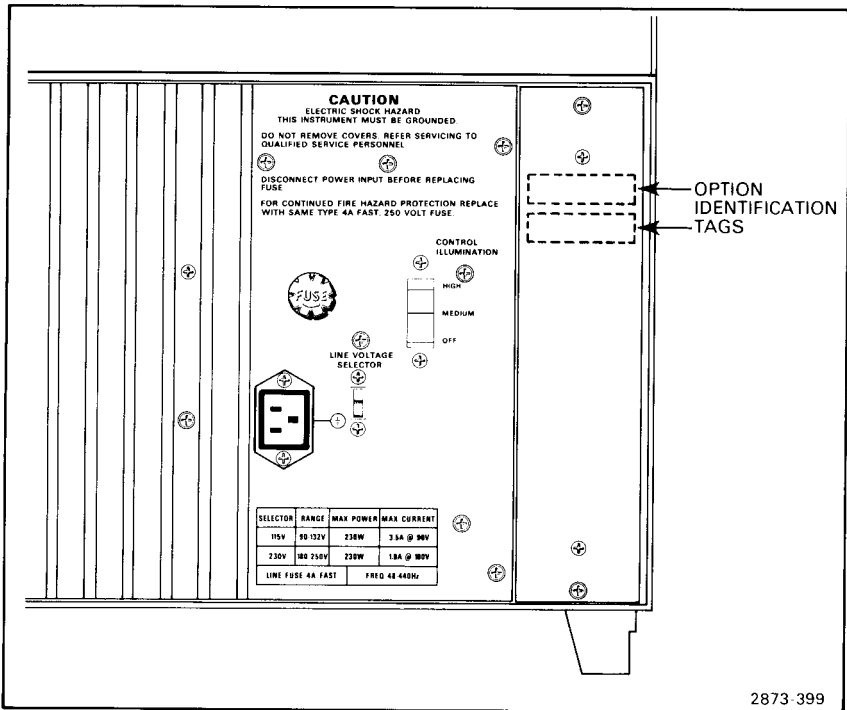

Figure 8-1. Location of Option Identification Tags.

TABLE 8-1
Option Information Locator

Option	Location in Manual		Information
	Section	Heading	
Ø2	8 Instrument Options	Option Ø2	Gives a brief description of Option Ø2.
Ø3	3 General Operating Information	Light Filter	Mentions that the crt mesh filter is included with Option Ø3.
	8 Instrument Options	Option Ø3	Gives a brief description of Option Ø3.
78	8 Instrument Options	Option 78	Gives a brief description of Option 78.
ØD	1 Introduction	General Purpose Interface Bus	Mentions that, except for instru- ments with Option ØD, the 7854 has a GPIB.
	5 Using The Measurement Keyboard	Introduction	Describes use of keyboard on 7854 Option ØD.
		Waveform Storage Considerations	Explains that with Option ØD, only one waveform can be stored at a time.
		Selecting Both CRT Display Mode	Describes display modes of 7854 Option ØD.
	6 Using The Waveform Calculator (Waveform Processing)	Waveform Memories & Resolution	Mentions that the Option ØD instrument will not process waveforms.
		Waveform Acquisition And Data Storage	Lists parameters of pulse of pulse acquisition for standard and Option ØD instruments in Table 6-1.

TABLE 8-1 (CONT)
Option Information Locator

Option	Location in Manual		Information
	Section	Heading	
ØD (cont)	7 GPIB Information	Introduction	Mentions that Option ØD deletes the GPIB, the Waveform Calculator keyboard, and 2,000 words of memory.
	8 Instrument Options	Option ØD	Gives a brief description of Option ØD.
2D ¹	6 Using The Waveform Calculator (Stored Display Mode Info)	Using The Constant Registers	Explains how the constant registers are referenced (by addresses 0-99) with Option 2D.
		Storing A A Constant	Explains how the constant registers are referenced (by addresses 0-99) with Option 2D.
		Retrieving A Constant	Explains how the constant registers are referenced (by addresses 0-99) with Option 2D.
	(Waveform Processing)	Waveform Acquisition & Data Storage	Lists parameters of pulse acquisition for standard and Option 2D instruments in Table 6-1.
		Observing The Waveform Memories At Power-Up	Mentions that the X register must contain a number within the limits of the P/W setting for Option 2D.
	8 Instrument Options	Option 2D	Gives a brief description of Option 2D.
	9 Command Language	Error And Warning Messages, Table 9-20	Mentions that the X register does not contain a constant between zero and 99.
		Displayed CNS Error Messages, CNS ERROR and >CN	Mentions that the X register does not contain a constant between zero and 99.

¹ Applies only to instruments with serial numbers below B085121. For instruments with serial number B085121 and above, features previously provided by Option 2D are standard.

TABLE 8-1 (CONT)
Option Information Locator

Option	Location in Manual		Information
	Section	Heading	
A1	1 Introduction	Operating Power Information (Table 1-2)	Lists details of Option A1.
	8 Instrument Options	Option A1	Gives a brief description of Option A1.
A2	1 Introduction	Operating Power Information (Table 1-2)	Lists details of Option A2.
	8 Instrument Options	Option A2	Gives a brief description of Option A2.
A3	1 Introduction	Operating Power Information (Table 1-2)	Lists details of Option A3.
	8 Instrument Options	Option A3	Gives a brief description of Option A3.
A4	1 Introduction	Operating Power Information (Table 1-2)	Lists details of Option A4.
	8 Instrument Options	Option A4	Gives a brief description of Option A4.
1S	8 Instrument Options	Option 1S	Gives a brief description of Option 1S.
2S	8 Instrument Options	Option 2S	Gives a brief description of Option 2S.

7854

OPW 2 UZR -2.87

500m

2.5

US 3

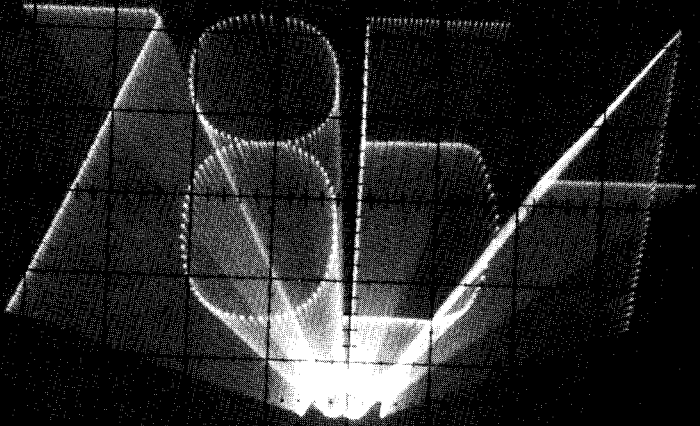

3 WFM

2 WFM US

Command Language

Information in this section is intended only as reference material on the operation of the 7854 Oscilloscope. The information is generally presented in a tabular format; however, all information about a command is not necessarily contained in only one table. Refer to the Command Index at the rear of this manual for the locations of related command information.

OPERATIONAL CONVENTIONS

The following conventions are intended as a reference guide to describe the overall operating principles of the 7854 Oscilloscope.

OPERATING MODES

Figure 9-1 illustrates the basic 7854 modes in order of priority. Column A lists the commands that can be executed when in the program Entry and Edit modes, and column B lists the commands that *cannot* be executed when in the program Execute mode.

CRT DISPLAY

The crt graticule lines are spaced 8 cm vertically and 10 cm horizontally, with markers each 0.2 cm. The character display area (within graticule outline) is assigned 16 lines, numbered 1 through 16, starting at the graticule top. Each line contains spaces for 40 characters, numbered 1 through 40, starting at the graticule left. Characters to be displayed have preassigned fields in the display area for each display mode, as illustrated in Figures 9-2, 9-3 and 9-4.

REAL-TIME WAVEFORMS AND READOUT DISPLAY

All real-time waveforms within the crt graticule area (8 by 10 cm) is valid. Readout is determined by the plug-in unit, and will be displayed as described in Figure 9-2. However, if the selected plug-in unit is not equipped to encode readout, the processor will assign a default scale factor and issue a warning.

STORED WAVEFORMS AND CHARACTER DISPLAY

All waveform data is valid within the acquisition graticule area of 10 by 10 cm. (Area extends vertically plus and minus one additional cm from the crt graticule.) Refer to Figure 5-1 for more information.

Horizontal Resolution: Stored waveform horizontal resolution depends upon the P/W selection (see Table 9-1).

TABLE 9-1
Points-Per-Waveform vs Horizontal Resolution

P/W	Horizontal Resolution (increments/div)
128	12.8
256	25.6
512	51.2
1024	102.4

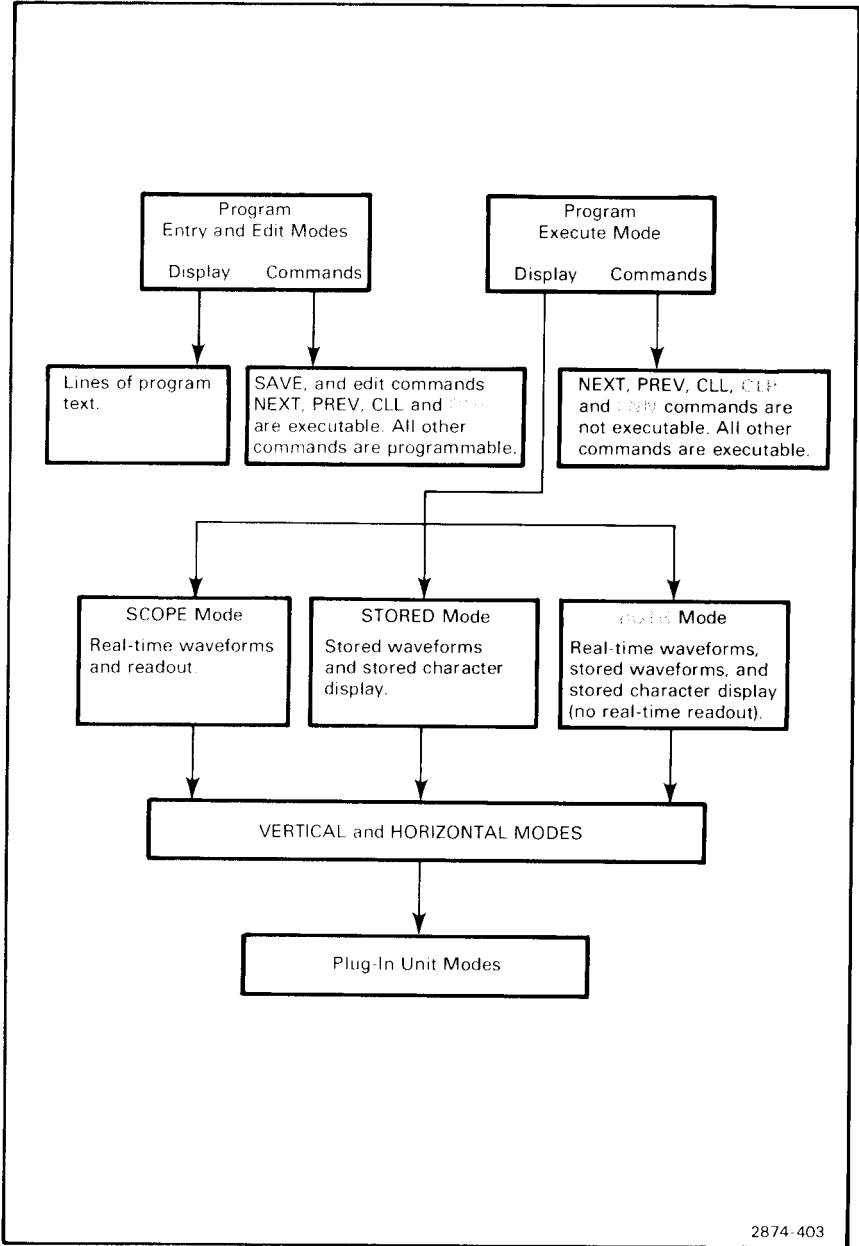

Figure 9-1. The 7854 hierarchy of operational modes.

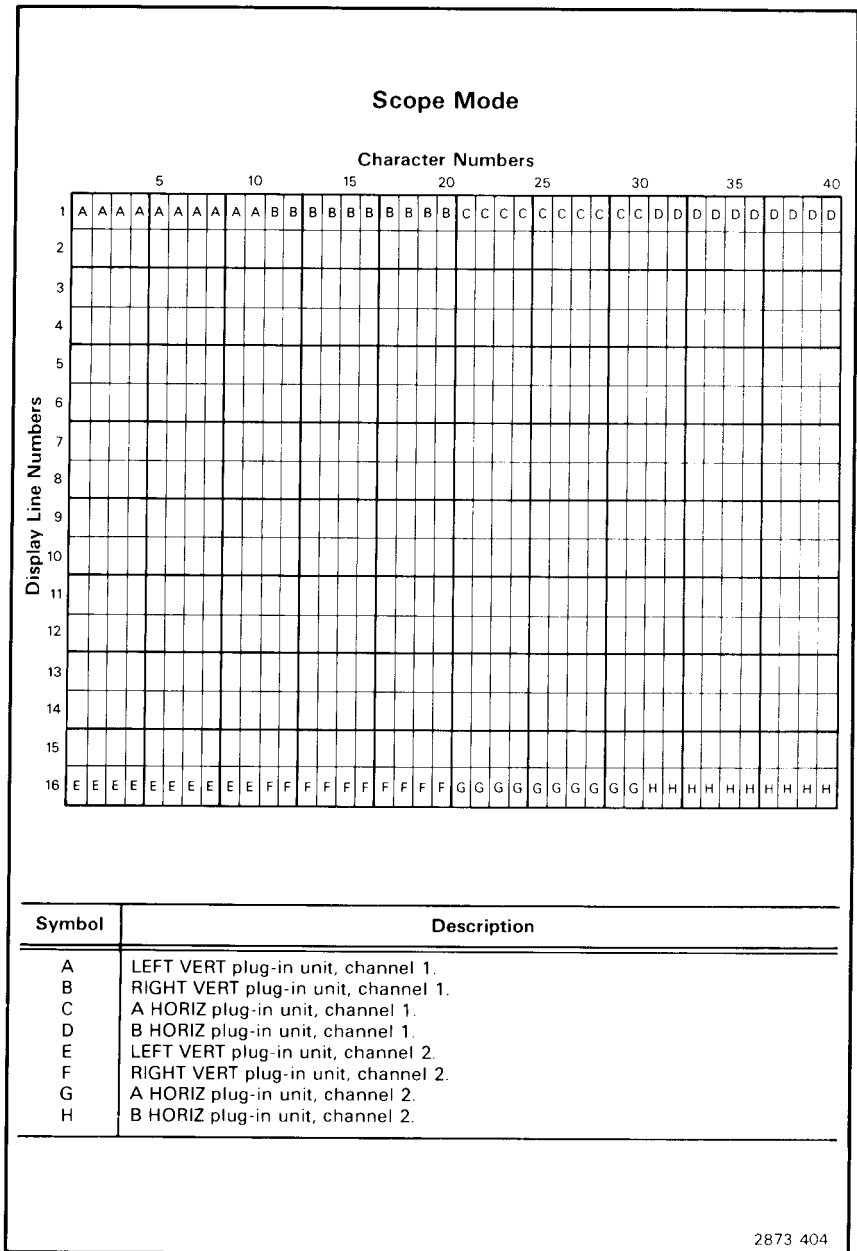

Figure 9-2. Character display fields utilized in the SCOPE mode.

		Character Numbers																																							
		5				10				15				20				25				30				35				40											
Display Line Numbers	1	A	A	A	*	B	B	*	C	C	C	*	D	D	D	D	D	E	E	E	E	E	E	E	E	E	F	G	G	G	G	G	G	G	G	G	H				
	2	I	I	I	*	J	J	*	J	J	*	J	J	*	J	J	*	J	J	*	J	J	*	J	J	*	J	J	*	*	*	*	K	K	*	L	L				
	3																																								
	4																																								
	5																																								
	6																																								
	7																																								
	8																																								
	9	M	M	M	M	M	M	M	M	M	M	M	M	M	N	N	N	N	N	N	N	O	O																		
	10	P	P	P	P	P	P	P	Q	Q	*	R	R	R	R	R	R	R	R	R	R	R	R	R	R	R	R	R	R	R	R	R	R	R	R	R	R	R	R		
	11																																								
	12	*	S	S	S	T	T	T	T	T	T	T	T	T	T	T	T	T	T	T	T	T	T	T	T	T	T	T	T	T	T	T	T	T	T	T	T	T	T		
	13	U	U	U	U	V	V	V	V	V	V	V	V	V	V	V	V	V	V	V	V	V	V	V	V	V	V	V	V	V	V	V	V	V	V	V	V	V	V	V	
	14																																								
	15	*	W	X	X	X	X	*	Y	*	Z	Z	Z	Z	Z	Z	Z	Z	*	*	a	b	b	b	b	*	c	*	d	d	d	d	d	d	d	d	d	d	*		
	16	e	e	e	e	e	e	e	e	e	*	h	h	h	h	h	h	h	h	i	i	i	i	i	i	i	i	i	i	i	i	i	i	i	i	i	i	i	i		

2873-405A

Figure 9-3. Character display fields utilized in the STORED or BOTH mode.

Stored or Both Mode		
Symbol	Description	
*	Blank space.	
A	OPW.	
B	Operational waveform number (left justified).	
C	VZR.	
D	Vertical zero number, in divisions (left justified).	
E	Vertical scale factor, per division (right justified).	
F	Vertical scale unit.	
G	Horizontal scale factor, per division (right justified).	
H	Horizontal scale unit.	
I	DSW.	
J	Integer, displayed waveform number (right justified).	
K	VS.	
L	Integer, horizontal axis waveform number (left justified).	
M	TEK/7854V79.1.	
N	Firmware version.	
O	Available RAM.	
P	ADDRESS:	
Q	Address.	
R	Talk/listen mode and terminator.	
S	ON:	
T	Status message.	
U	OFF:	
V	Status message.	
W	Blank if one cursor on; Δ if two cursors on.	
X	VCRD.	
Y	=	
Z	Vertical cursor coordinate including unit (left justified).	
a	Blank if one cursor on; Δ if two cursors on.	
b	HCRD.	
c	=	
d	Horizontal cursor coordinate including unit (left justified).	
e	Y constant (right justified).	Display is either a constant, or a waveform number followed by the mnemonic WFM.
f	Y waveform number (right justified).	
g	WFM	
h	X constant (right justified).	
i	X waveform number (right justified).	
j	WFM.	
k	Key mnemonic (left justified).	If no status message follows the mnemonic, the entire mnemonic is displayed. If a status message does follow the mnemonic, it is truncated to 3 characters.
l	Key mnemonic (left justified).	
m	Status message (left justified).	
n	PL.	
o	Program line number.	

2873-4058

Figure 9-3 (cont.) Character display fields utilized in the STORED or BOTH mode.

Vertical Resolution: 102.4 increments/div (only at time waveform is stored into memory); P/W is fixed at 512 with Option 0D.

Y-T Mode

The components of a stored waveform superimposed upon a calibrated graticule are:

1. **Vertical Scale Factor.** Specifies the numeric value of each vertical division and the associated unit (e.g., V). Scale factors are constants, and have the same range and precision as positive constants.
2. **Horizontal Scale Factor.** Specifies the numeric value of each horizontal division and the associated unit (e.g., S).
3. **Waveform.** Consists of vertical coordinates (in units of vertical graticule divisions) corresponding to the individual points of the waveform. Waveforms are displayed as a series of points at the specified graticule locations, with or without connecting vectors.

The points are numbered, for reference, from 0 to the points-per-waveform minus one. Waveform values have a maximum range of ± 20 divisions, and are stored within a resolution of 1/1638.4 of a division. The stored waveform vertical range is ± 20 divisions from vertical zero. Also, each point must be less than 20 divisions from every other point.

4. **Vertical Zero.** Specifies the vertical location (in graticule divisions) of waveform zero with relation to crt graticule zero. The vertical zero values have a maximum range of ± 20 divisions, and are stored with a resolution of 1/1638.4 of a division. When the display location is specified in graticule divisions, vertical zero is at the specified graticule location, with positive upward.
5. **Horizontal Zero.** When the display location is specified in graticule divisions, horizontal zero is at the left edge of the graticule, with positive to the right.

X-Y Mode

The horizontal position of each displayed waveform point represents the vertical value of the corresponding waveform point on the horizontal waveform; the corresponding waveform point location is measured from the horizontal graticule center (zero reference) and is measured in divisions, with positive to the right.

The mnemonic VS, followed by the horizontal waveform number, is displayed on line 2 of the character display field. Refer to Figures 9-2 and 9-3.

The displayed horizontal scale factor is the same as the horizontal waveform vertical scale factor.

The horizontal cursor-coordinate display reflects the displayed horizontal scale factor, (i.e., HCRD = (divisions)*(HSCL)). This is, in effect, the VCRD value of the cursor points on the horizontal waveform.

STORED WAVEFORM ACQUISITION

Waveform acquisition is the storage of real-time waveforms into the waveform memory. Waveform and scale factors are acquired because both are required to fully specify waveform values.

REAL-TIME WAVEFORM ACQUISITION

The digitizer converts the displayed real-time waveform(s) into numeric form for storage in the data memory. The generated digital data corresponds to that observable visually, such as graticule division and scale factor terms. The only deliberately introduced changes are due to quantizing.

The instrument acquisition system operates properly with single-valued functions of the horizontal variable. X-Y type waveforms will not be correctly acquired.

The digitizer control starts and stops the digitizer, and also controls its mode. Real-time single-shot, equivalent-time sampled, and signal averaged modes are available.

REPETITIVE DIGITIZING

Repetitive digitizing uses equivalent-time sampling to construct complete waveform(s) from many repetitions of the same real-time waveform(s); this mode is useful at all sweep speeds.

The digitizer simultaneously samples and quantizes the horizontal and vertical real-time trace location. The horizontal value specifies the point number where the vertical value is stored.

Sampling is asynchronous with respect to the sweep. Only those samples taken while the sweep gate is on are considered valid. Samples taken from portions of the real-time trace horizontally outside the graticule are loaded into the corresponding extreme stored points (hence these points are generally erroneous). At any time during digitizing, most points will have been sampled more than once (the latest data is retained), while some may not have been filled at all.

Waveform acquisition terminates when either of the following occurs:

1. At least 99% of all sampled points of the real-time waveform are stored into memory, and at least one complete sweep has occurred.
2. A STOP command from the keyboard is received.

REAL-TIME DIGITIZING

Real-time digitizing samples and digitizes only one occurrence of the real-time waveform(s). The fastest equivalent sweep speed at which this mode is usable is limited by the maximum sample rate at which the digitizer hardware can operate.

The instrument requires a clock-generator time base to supply a clock, which then determines the sampling rate. An external clock signal may also be connected via the plug-in's external clock connector.

During digitizing, vertical signals are sampled every clock cycle, digitized, and then stored in memory. The memory contains the last P/W samples, or all samples if fewer clock cycles have occurred.

UNFILLED/ERRONEOUS POINTS

After termination, any unfilled and known erroneous points are corrected as follows:

Up to 0.01 of the total sampled points in the on-screen portion (horizontally) of the trace may not have been digitized. These are randomly distributed, and are filled by linear interpolation from adjacent valid data. When the real-time trace terminates outside the horizontal graticule boundary, the corresponding stored waveform end point(s) are set to the same value(s) as the adjacent point(s). When the trace terminates on-screen, the stored end point data is copied to all unfilled points, to the end of the waveform.

If no points are filled, due to a forced STOP before any or enough sweeps have occurred, the scale factors are acquired as described, and all waveform points are set to zero.

WAVEFORM STORAGE

Waveform data is stored in a digital storage area.

A stored waveform is represented by a sequence of 16-bit binary integers. Each number represents a point of the waveform.

Points-per-Waveform (P/W) is the number of points in a waveform. Points are numbered from 0 through [(P/W)-1] and are assumed to be uniformly spaced at increments of $(10 / [(P/W)-1])$ divisions along the horizontal graticule axis. Point 0 is at the left edge of the graticule.

The stored data format is used directly for internal input from the digitizer and output to the display. (The user numerical access is via software routines which transform the internal format to and from the external decimal form.)

WAVEFORM RESULTS

New waveform data generated by computation is always stored at waveform memory address 0 WFM.

OVERFLOW AND UNDERFLOW

Large and Small Constants

The largest internally representable constant magnitude is approximately 10^{308} or $2^{32.767}$; larger constants are set to this magnitude with the proper sign. The largest constant magnitude that can be displayed is 10^{99} ; larger constants are displayed as: (mantissa sign) *****.

The smallest internally representable constant magnitude is approximately 10^{-308} or $2^{-32.767}$; smaller constants are set to zero.

The smallest constant magnitude that can be displayed is 10^{-99} ; smaller constants are displayed as zero.

Large and Small Waveforms

All waveform point values larger than the largest constant magnitude are set to that magnitude with the proper polarity, and are displayed at the plus or minus 3 division level. All other waveform points are set to zero.

Waveform point values smaller than the smallest magnitude may be accessed externally (e.g., by waveforms). If all waveform values are smaller than the smallest magnitude, the entire waveform value is set to zero.

INSTRUMENT COMMANDS

The following tables list all the commands, and provide a concise description of their functions.

ARITHMETIC FUNCTIONS

The commands ABS through SQRT, listed in Table 9-2 are performed on a single constant or waveform operand; the remaining commands (+, -, *, /) are performed on two constant or waveform operands. Table 9-3 lists operand types and results when using the Y and X registers for mathematical computations.

TABLE 9-2
Arithmetic Commands

Command	Execution
ABS (Returns Absolute Value)	Function: Computes absolute value of contents of X register, and returns result to X register. The result is not autoscaled; and if the operand is a waveform, the VZR and vertical scale factor are retained.
	Stack: Pops contents of X register; pushes result back into X register.
	Vertical Scale Factor Units: Remains same as operand unit.
EXP (Exponential)	Function: Computes exponential function of X register contents, and returns result to X register.
	Stack: Pops contents of X register; pushes result back into X register.
	Scale Factor Units: Blanked if operand is waveform.
LN (Returns Natural Logarithm)	Function: Computes natural logarithm of absolute value of contents of X register; returns result to X register.
	Stack: Pops contents of X register; pushes result back into X register.

TABLE 9-2 (CONT)
Arithmetic Commands

Command	Execution
LN (cont)	<p>Scale Factor Unit: Blanked if operand is a waveform.</p>
	<p>Warning: Issued if the X register contains either a negative or zero constant, or a waveform memory address in which any point of the waveform is negative or zero.</p>
SGN (Returns Signum)	<p>Function: Computes signum of X register contents, and returns result to X register. Result is not autoscaled; if operand is a waveform the vertical scale factor is set to 1, and is set to .</p>
	<p>Description: The signum of the contents of the X register equals:</p> <ul style="list-style-type: none"> 1 where contents of X register is greater than 0. 0 where contents of X register is 0. -1 where contents of X register is less than 0.
	<p>Stack: Pops contents of X register; pushes results back into X register.</p>
	<p>Both Scale Factor Units: Blanked if operand is waveform.</p>
SQRT (Returns Square Root)	<p>Function: Computes square root of absolute value in X register; returns result to X register.</p>
	<p>Stack: Pops contents of X register; pushes result back into X register.</p>
	<p>Scale Factor Units: Blanked if operand is a waveform.</p>
	<p>Warning: Issued if the X register contains either a negative constant, or a waveform memory address in which any point of the waveform is negative.</p>

TABLE 9-2 (CONT)
Arithmetic Commands

Command	Execution
+ (Add)	<p>Function: Adds contents of Y register to contents of the X register; returns result to X register.</p>
	<p>Stack: Pops contents of X and Y registers; pushes result back to X register.</p>
- (Subtract)	<p>Function: Subtracts contents of X register from contents of Y register; returns results to X register.</p>
	<p>Stack: Pops contents of X and Y registers; pushes result back to X register.</p>
* (Multiply)	<p>Function: Multiplies contents of Y register by contents of X register; returns result to X register.</p>
	<p>Stack: Pops contents of X and Y registers; pushes result back to X register.</p>
/ (Divide)	<p>Function: Divides contents of Y register by contents of X register; returns result to X register.</p>
	<p>Stack: Pops contents of X and Y registers; pushes results back to X register.</p>
	<p>Warning: Issued if the X register (divisor) contains either a zero constant, or a waveform memory address in which any point of the waveform is zero. The result is internally set to the largest representable binary number of the same sign as the Y register (dividend); a field of eight * (asterisks) preceded by the appropriate sign is displayed. However, if the Y register also contains a zero, or a waveform memory address in which the corresponding point of the waveform is also zero, the result is set to zero.</p>

TABLE 9-3
Operands and Results

Operands (Contents of Y and X Registers)	Result
Two Constants	A constant, returned to X register.
Two Waveforms	A waveform returned to waveform memory address 0 WFM. (Each resulting waveform point is calculated by applying the specified operation to the corresponding points of the referenced waveforms.)
Scale Factors	If both horizontal scale factors of the referenced waveforms are the same, the resulting waveform has the same scale factor; otherwise, the scale factor is assigned a value of "1" and a warning is issued.
Scale Factor Units	Horizontal: If both horizontal scale factors and units of the referenced waveforms are the same, the resulting scale factor unit is the same; otherwise, the unit is blank.
	Vertical: For + and - functions the resulting vertical scale factor unit is blank if the two referenced waveforms have differing vertical units. For * and / functions the resulting vertical scale factor unit is blank.
Constant and Waveform	A waveform returned to waveform memory address 0 WFM. (Each resulting waveform point is calculated by combining each waveform point with the constant value.)
Scale Factor Units	The vertical and horizontal scale factor units of the resulting waveform are the same as the operand waveform.

CRT DISPLAY

Table 9-4 lists the overall display content as selected by the CRT DISPLAY commands.

TABLE 9-4
CRT Display Commands

Command	Execution
SCOPE (Scope Display)	Function: Selects real-time waveform(s) and readout display on crt.
STORED (Stored Data Display)	Function: Selects stored data display on crt.
BOTH (Combined Display)	Function: Selects a combined display, consisting of a stored data display plus the real-time waveform(s) only; no real-time readout is displayed.

CURSORS

Cursors are one or two specially identified points displayed (with bright dots) on the operational waveform. The cursors delimit portions of the waveform for waveform parameter calculations. They also have special significance for pulse parameter measurements. Refer to Table 9-5, Cursor Commands, for functions and restrictions.

ONE CURSOR

Cursor 1 is displayed on a point of the operational waveform.

VCRD is the vertical coordinate of Cursor 1's point, in scale factor units, relative to VZR.

HCRD is the horizontal coordinate of Cursor 1's point, relative to the start of the waveform, in scale factor units.

TWO CURSORS

Cursors 1 and 2 are displayed on points of the operational waveform.

ΔVCRD is the vertical location of Cursor 2 relative to Cursor 1, in scale factor units. (ΔVCRD setting is equal to the operational waveform value at Cursor 2 minus the operational waveform value at Cursor 1.)

HCRD is the horizontal location of Cursor 2 relative to Cursor 1, in scale factor units. HCRD setting is equal to the Cursor 2 point number minus Cursor 1 point number times the horizontal increment.)

CURSOR MOVEMENT

Cursor movement is described in terms of horizontal position along the operational waveform. Therefore, the vertical position is determined by the horizontal position.

Restrictions

1. Each cursor must coincide with an operational waveform point.
2. Cursor 1 can be moved to any operational waveform point.
3. Cursor 2 can be moved to any point in the portion of the waveform between, and including, Cursor 1 and the end of the waveform.
4. For stored programs, only the initial actuation of the manual slewing keys is stored and executed.
5. Cursors can be positioned via the manual slewing keys **CRS1<** , **CRS1>** , **CRS2<** , and **CRS2>** . The initial actuation moves the cursor by one point. If the key remains actuated longer than approximately 300 milliseconds, the cursor begins continuous movement, slowly at first, accelerating in about 1 second to maximum speed. Releasing the key terminates the cursor movement.
6. Cursors can be positioned directly with the >VCRD and >HCRD commands.
7. The cursor coordinates can be returned to the X register with the VCRD and HCRD commands.

TABLE 9-5
Cursor Commands

Command	Execution
OFF (Cursors Off)	Function: Turns off cursors.
CRS1 (One Cursor On)	<p>Function: Turns on Cursor 1.</p> <p>Display: Cursor 1 is displayed on the operational waveform. Coordinates are displayed in scale factor units.</p>

TABLE 9-5 (CONT)
Cursor Commands

Command	Execution
CRS2-1 (Both Cursors On)	<p>Function: Turns on Cursors 1 and 2.</p> <p>Display: Cursors are displayed on the operational waveform. Relative coordinates are displayed in scale factor units.</p>
CRS1< (Cursor 1 Left)	<p>Function: Moves Cursor 1 toward start of waveform.</p> <p>Restriction: Cursors cannot be OFF.</p> <p>Warning: Issued if Cursor 1 is at start of waveform.</p>
CRS1> (Cursor 1 Right)	<p>Function: Moves Cursor 1 toward end of waveform (picks up Cursor 2, displayed or not).</p> <p>Restriction: Cursors cannot be OFF.</p> <p>Warning: Issued if Cursor 1 is at end of waveform.</p>
CRS2< (Cursor 2 Left)	<p>Function: Moves Cursor 2 toward start of waveform.</p> <p>Restriction: Cursor 2 must be displayed (in CRS2-1 mode).</p> <p>Warning: Issued if Cursor 2 is at Cursor 1 location.</p>
CRS2> (Cursor 2 Right)	<p>Function: Moves Cursor 2 toward start of waveform.</p> <p>Restriction: Cursor 2 must be displayed (in CRS2-1 mode).</p> <p>Warning: Issued if Cursor 2 is at end of waveform.</p>
>HCRD (Set Horizontal Coordinate)	<p>Function: Moves Cursor 1 (in CRS1 mode) or Cursor 2 (in CRS2-1 mode) so that the horizontal coordinate, or relative coordinate, is equal to the value in the X register.</p>

TABLE 9-5 (CONT)
Cursor Commands

Command	Execution
HCRD (cont)	<p>Restriction: Cursors must not be OFF; constant in X register must be ≥ 0; display mode must not be in X-Y.</p>
	<p>Warning: Issued if constant in X register represents a position beyond the right graticule edge. Simultaneously sets cursor(s) to right graticule edge.</p>

NOTE

The cursor is set to the nearest stored point when the specified position does not coincide with a stored point.

VCRD (Set Vertical Coordinate)	<p>Function: Moves Cursor 1 (in CRS1 mode) or Cursor 2 (in CRS2-1 mode) so that the vertical coordinate, or relative vertical coordinate, is equal to value in X register.</p>
	<p>Restriction: Cursors must not be OFF. The operational waveform must cross or touch the specified vertical level (contained in X register) somewhere within the allowed cursor movement range.</p>

NOTE

In all searching operations to be described, scanning always begins halfway between the initial location of the cursor to be moved, and the following point. If the next crossing is nearest to the present cursor location, that crossing is ignored.

In CRS1 mode, the operational waveform is scanned from Cursor 1 to the end of the waveform. If a crossing is not found, the scan continues from the start of waveform back to the cursor location. The cursor is set to the first crossing or touching point found.

In CRS2-1 mode, the operational waveform is scanned from Cursor 2 toward the end of the waveform. If a crossing is not found, the scan continues from Cursor 1 forward to Cursor 2. Cursor 2 is then set to the first crossing or touching point found, where the touching point is preceded by at least one point of a different value. If the specified vertical level does not coincide with a stored point value, the cursor is set to the point which has the nearest vertical value.

TABLE 9-5 (CONT)
Cursor Commands

Command	Execution
VCRD (Returns Vertical Coordinate)	Function: Copies the displayed vertical coordinate (CRS1 mode), or relative coordinate (CRS2-1 mode), into the X register.
	Stack: Pushes the result into the X register.
	Restriction: Cursors cannot be OFF.
HCRD (Returns Horizontal Coordinate)	Function: Copies the displayed horizontal coordinate (CRS1 mode), or relative coordinate (CRS2-1 mode), into the X register.
	Stack: Pushes the result into the X register.
	Restriction: Cursors cannot be OFF.

DATA STORAGE

Table 9-6 lists the commands and functions used for storing and retrieving waveform and constant data.

TABLE 9-6
Data Storage Commands

Command	Execution
CNS (Return Constant)	Function: Contents of a constant register (designated by address number in X register) are returned to X register.
	Stack: Pops X register; pushes contents of constant register into X register.
	Restriction: X register must contain constant which, when rounded to nearest integer, is from 0 to 49 (0 to 99 with Option 2D ¹), inclusive.

¹ Applies only to instruments with serial numbers below B085121. For instruments with serial number B085121 and above, features previously provided by Option 2D are standard.

TABLE 9-6 (CONT)
Data Storage Commands

Command	Execution
<p>▷CNS (Store Constant)</p>	<p>Function: Copies contents of Y register to constant register number given in X register; if contents of Y register is a waveform address, copies WFM number to X register.</p> <hr/> <p>Stack: Pops X register.</p> <hr/> <p>Restriction: X register must contain constant which, when rounded to nearest integer, is from 0 to 49 (0 to 99 with Option 2D¹), inclusive.</p>
<p>PNT (Return Waveform Point Value)</p>	<p>Function: Returns vertical value of operational waveform point number referenced in X register, to the X register.</p> <hr/> <p>Stack: Pops the operational waveform point number from the X register; pushes vertical value to X register.</p> <hr/> <p>Restriction: Contents of X register (rounded to nearest integer) must be from 0 to [(P/W)-1], inclusive.</p>
<p>PNT (Set Waveform Point Value)</p>	<p>Function: Sets operational waveform point in X register to value contained in Y register.</p> <hr/> <p>Stack: Pops X register.</p> <hr/> <p>Restriction: Contents of X register (rounded to nearest integer) must be between, and including, zero and value of (P/W minus one). Contents of Y register must be a constant which, when divided by the vertical scale factor is within the vertical range limits of the waveform. See Y-T Mode in Operational Conventions, at the beginning of this section.</p>
<p>P/W (Return Points Per Waveform Setting)</p>	<p>Function: Copies points per waveform setting into X register.</p> <hr/> <p>Stack: Pushes X register.</p>

¹ Applies only to instruments with serial numbers below B085121. For instruments with serial number B085121 and above, features previously provided by Option 2D are standard.

TABLE 9-6 (CONT)
Data Storage Commands

Command	Execution
<p>>P/W (Set Points Per Waveform)</p>	<p>Function: Reconfigures waveform memory so that the size of all waveforms (points per waveform) is the same as the constant in the X register, providing it is one of the available sizes (128, 256, 512, or 1024). Performs implicit CLD command.</p> <p>Stack: Clears stack (all registers equal to zero).</p> <p>Restriction: Contents of X register must be either 128, 256, 512, or 1024, where contents of X register is rounded to nearest integer.</p>
<p>WFM (Recall Waveform)</p>	<p>Function: Contents of waveform memory (number in X register) becomes operational waveform.</p> <p>Stack: Pops X register; pushes waveform address to X register.</p> <p>Restriction: X register must contain a constant which, when rounded to nearest integer, is from 0 to maximum valid waveform memory address number (inclusive).</p>
<p>-WFM (Copy Stored Waveform)</p>	<p>Function: Copies operational waveform into waveform memory (address number in X register).</p> <p>Stack: Pops X and Y registers; pushes waveform address to X register.</p> <p>Restriction: Y register must contain valid waveform memory address. X register must contain a constant which, when rounded to nearest integer, is from 0 to maximum valid waveform memory address number (inclusive).</p>

TABLE 9-7 (CONT)
External Interface Commands

Command	Execution
READ x (Read Data From External Interface)	Function: Inputs data from external interface: Received in X register if data record is constant; received in waveform memory address 0 WFM if data record is a waveform.
	Stack: Pushes constant or waveform memory address, 0 WFM, to X register.
	Restriction: GPIB interface must be properly selected, and incoming data must be of proper format and contents. Refer to Section 7, GPIB Information.
RQS (Request Service)	Function: Sends rsv (7854 local service request message) to interface if enabled by GPIB REMON command.
SAVE (Save Program)	Function: Sends one record consisting of stored program text to external interface; current program line through end-of-program is sent.
	Restriction: GPIB interface must be properly selected and current program line must not be end-of-program.
	Programmability: Command not programmable.
SEND x (Send Data to External Interface)	Function: Transmits contents of X register (if constant) to external interface; if X register contains waveform memory address, transmits corresponding waveform memory contents to external interface.
	Stack: Pops X register.
	Restriction: GPIB interface must be properly selected.
SWH (Set Output High)	Function: Sets signal output at rear-panel TTL SIGNAL OUTPUT connector to high state.
SWL (Set Output Low)	Function: Sets signal output at rear-panel TTL SIGNAL OUTPUT connector to low state.

NUMBER ENTRY

Table 9-8 lists the number entry commands as executed from the Waveform Calculator keyboard. Table 9-9 describes the functions and character positions within the number entry field.

TABLE 9-8
Number Entry Commands

Command	Execution
(Decimal Point)	Function: Enter and display decimal point in mantissa.
	Stack: Pushed at first decimal point (or number) entry.
	Warning: An audible tone and stored display blink (numeric warning) occurs if more than one decimal point is entered in mantissa, or if decimal point entry in exponent (following EEX) is attempted; WARNING message not displayed.
0,1,2,3,4,5,6,7,8,9 (Digits)	Function: Input constants from keyboard (mantissa or exponent after EEX).
	Display: Number entry displayed.
	Stack: Pushed at first number (or decimal point) entry.
EEX (Enter Exponent)	Function: Begins exponent entry.
	Display After Mantissa Entry: Mantissa followed by exponent identifier (E), initial esign (), and value ().
	Display Without Mantissa Entered: Default mantissa () and decimal point (.), followed by exponent identifier, esign, and evaluate.
	Stack (Without Mantissa Entered): Pushes stack.
	Warning: Numeric warning issued if in exponent entry mode and EEX is initiated again, or if decimal point is issued.

TABLE 9-8 (CONT)
Number Entry Commands

Command	Execution
CHS (Change Sign)	Function: Changes sign of X register value, or of exponent during exponent entry.
	Restriction: X register must contain a constant.

NUMERIC ENTRY

Number entry begins with a digit, decimal point, or EEX command following any nonnumeric command.

Constants may enter the stack in two distinct ways:

1. By a sequence of numeric commands from the keyboard or GPIB.
2. As a result of a command execution.

Number Entry Display

Numbers entered are displayed in a number entry field as described in Table 9-9.

TABLE 9-9
Number Entry Field

Horizontal Character Position (Display Line 16)	Function
12	Mantissa Sign: Minus sign displayed if negative (blank if positive), and is entered with CHS command.
13-25	Mantissa: 12 digits (or 11 digits and 1 decimal point). Entry is started with any digit or decimal point, and is terminated by EEX or any nonnumeric command except CHS, RUN, STEP, STOP, or PAUSE. The first character (decimal point, entered digit, or a default 1) is displayed in horizontal position 13. Entered digits are displayed to the right of existing digits, up to position 25. The terminating command rounds the displayed mantissa to four significant digits.

TABLE 9-9 (CONT)
Number Entry Field

Horizontal Character Position (Display Line 16)	Function
---	----------

NOTE

*An **f** command during number entry blanks character positions 22 through 26 inclusive, and the mnemonic **E** is displayed; however, the internal numeric value is not affected. A **CLf** or any nonshift function will return the display to normal.*

26-29	Exponent (EEX): Exponent identifier, sign, and two digits are displayed (E·00) following the mantissa:
26	E (Exponent identifier.)
27	· or (Exponent sign is initially positive.)
28, 29	00 (Exponent digits; digits move to left as entered, but only last two entered are retained and displayed.) Exponent entry starts with EEX command and is terminated by any nonnumeric command except CHS, RUN, STEP, STOP, or PAUSE. If no mantissa was entered, a default mantissa of is assigned and displayed.

PROGRAM ENTRY/EXECUTE

Table 9-10 lists the program Entry and Execute commands executed from the Waveform Calculator keyboard.

TABLE 9-10
Program Entry and Execute Commands

Command	Execution
CLL (Clear Program Line)	<p>Function: In program Entry mode, deletes new line and returns to Edit mode with edit prompt at line following the new line. In Edit mode, deletes current line command group and leaves edit prompt at same line number. Program text following the deleted line is moved up to close the gap (line numbers of all following command groups are reduced by one).</p>
	<p>Restriction: Must be in program Entry or Edit mode and edit prompt must not be at end-of-program line.</p>
	<p>Programmability: Command not programmable.</p>
CLP (Clear Program Memory)	<p>Function: Clears entire program memory.</p>
	<p>Confirmation: When CLP is received, an audible warning is given, and the program display shows only the statement "NEXT TO RETURN TO EDIT MODE". A NEXT command will complete the CLP function. Any other command will abort the CLP command and will restore the previous status.</p>
	<p>Restriction: Must be in program Entry or Edit mode.</p>
EXECUTE (Execute Mode)	<p>Function: Selects program Execute mode when executed (or selects program Entry or Edit mode if already in Execute mode).</p>
	<p>Programmability: Command not programmable.</p>

TABLE 9-10 (CONT)
Program Entry and Execute Commands

Command	Execution
<p>GOTO (Go To Program Line)</p>	<p>DIRECTLY ISSUED</p> <p>Function: Next program command becomes first command in program line number in X register; remains in idle state.</p> <hr/> <p>Stack: Pops X register.</p> <hr/> <p>Restriction: The X register must contain a constant which, when rounded to the nearest integer, is from 0 to 999 (inclusive).</p> <hr/> <p>Warning: Issued if the X register contains a constant greater than the last stored program line number. (Edit prompt goes to end-of-program line; and line number removed from display line 16.)</p> <hr/> <p>STORED EXECUTION</p> <p>Function: In Step state, returns to idle state; next program command is first command of program line number in X register. In Run state; continues execution at first command of program line number in X register.</p> <hr/> <p>Display: Current program line number (in X register) is in display line 16.</p> <hr/> <p>Stack: Pops X register.</p> <hr/> <p>Restriction: The X register must contain a constant which, when rounded to the nearest integer, is from 0 to 999 (inclusive).</p> <hr/> <p>Warning: Issued if the X register contains a constant greater than the last stored program line number. (Edit prompt goes to end of program; and line number removed from display.)</p>

TABLE 9-10 (CONT)
Program Entry and Execute Commands

Command	Execution
GSB (Go To Subroutine)	<p>DIRECTLY ISSUED</p> <p>Function: Next command in program becomes first command in program line number in X register; returns to idle state.</p> <hr/> <p>Display: Current program line number is in display line 16.</p> <hr/> <p>Return Register: Advances to command following the GSB command.</p> <hr/> <p>Stack: Pops X register.</p> <hr/> <p>Restriction: The X register must contain a constant which, when rounded to the nearest integer, is from 0 to 999 (inclusive). Not more than 10 levels of nesting is allowed.</p> <hr/> <p>Warning: Issued if the X register contains a constant greater than the last stored program line number. (Edit prompt goes to end-of-program line.)</p> <hr/> <p>STORED EXECUTION</p> <p>All details same as listed above except: If executed in Run state, remains in Run state and continues execution from next command.</p>
IFX=J (If Contents Of X Register Is Equal To Contents Of Y Register)	<p>DIRECTLY ISSUED</p> <p>Function: Compares contents of Y and X registers.</p> <hr/> <p>Operation: If the contents of the Y and X registers are both constants, a simple comparison is made. The test is if the displayed contents of both registers have identical values.</p> <p>If the contents of the Y and X registers are both referenced waveforms, values at corresponding pairs of points are compared.</p>

TABLE 9-10 (CONT)
Program Entry and Execute Commands

Command	Execution
<p>IFX=Y (cont)</p>	<p>The test is TRUE if the difference is zero at all points (between cursors, if on). If only one of the registers holds a constant, it is treated as a waveform of constant value.</p> <hr/> <p>Display: TRUE or FALSE status message, depending on result of comparison.</p> <hr/> <p>STORED EXECUTION Function: Continues execution, if result of comparison is TRUE, at next command; otherwise, execution continues at first command of next program line. Scale factor units are ignored if different.</p> <hr/> <p>Operation and Display: All details same as above.</p>
<p>IFY>X (If Contents Of Y Register Is Greater Than Contents Of X Register)</p>	<p>DIRECTLY ISSUED Function: Compares contents of Y and X registers.</p> <hr/> <p>Operation: A simple comparison is made between the contents of the X and Y registers, if both are constants. If both are referenced waveforms, values at corresponding points are compared. The test is TRUE if the contents of the Y register exceeds that of the X register at one or more points (between cursors, if on). If only one of the registers is a constant, it is treated as a waveform of constant value.</p> <hr/> <p>Display: Mnemonic and TRUE or FALSE status message, depending on results of comparison.</p> <hr/> <p>STORED EXECUTION Function: Continues execution, if result of comparison is TRUE, at next command; otherwise, execution continues at first command of next program line.</p> <hr/> <p>Operation and Display: All details same as above.</p>

TABLE 9-10 (CONT)
Program Entry and Execute Commands

Command	Execution
LBL (Return Label Line)	Function: Returns number of program line containing first occurrence of label number in X register, to the X register.
	Stack: Pops X register; pushes result to X register.
	Restriction: The X register must contain a constant which, when rounded to the nearest integer, is from 0 to 99 (inclusive). The label specified in the X register must occur in the stored program.
LNN (Begin Label)	Function: Begins storing a label in the program; this command must be followed by two digits. Label entry ends (label is stored) when second digit is received.
	Display: Program display shows: LNN (after LNN command) LaN (a is the first digit) Lab (b is the second digit)
	Restriction: The LNN command must be followed by two digits, or by a CLL or CLP command. Must be in program Entry or Edit mode.
NEXT (Advance to Next Line)	Function: In program Entry state, terminates new line being entered and returns to program Edit state with edit prompt at next line; in Edit state, repetitively advances edit prompt to next line.
	Automatic NEXT: If (in program Entry mode) a programmable command is received whose mnemonic would cause the program line to exceed the allowed length (35 characters), an automatic NEXT is executed to terminate the line, and the mnemonic is automatically inserted at the start of a new line.

TABLE 9-10 (CONT)
Program Entry and Execute Commands

Command	Execution
NEXT (cont)	Restriction: Must be in program Entry or Edit mode and edit prompt must not be at end-of-program line.
	Warning: Issued when new line started.
	Programmability: Command not programmable.
PAUSE (Pause)	Function: Stops command execution for approximately 0.7 seconds. This command does not terminate a numeric command sequence.
PREV (Back To Previous Line)	Function: If in program Entry mode, terminates new line being inserted and returns to Edit mode with edit prompt at new line; in Edit mode, backs edit prompt to previous line. If key remains activated for more than 300 milliseconds, edit prompt backs through the program at approximately 8 lines per second.
	Restriction: Must be in program Entry or Edit mode and edit prompt must not be on line 000.
	Programmability: Command not programmable.
PROG (Program Entry)	Function: Selects program Entry or Edit mode when executed (or selects Execute mode if already in program Entry or Edit mode).
	Current Program Line: Identified by the edit prompt (➤) which remains on display line 8 (left edge at crt center) throughout program entry or edit.
	Programmability: Command not programmable.
RTN (Return From Subroutine)	<p>DIRECTLY ISSUED</p> <p>Function: Next command becomes command identified by return register; clears register and returns to idle.</p>
	Restriction: Return register must be set.

TABLE 9-10 (CONT)
Program Entry and Execute Commands

Command	Execution
RTN (cont)	<p>STORED EXECUTION</p> <p>All details same as above except: In Run state, remains in Run state and continues execution from new next command.</p>
RUN (Run Program)	<p>DIRECTLY ISSUED</p> <p>Function: System goes to Run state of Execute mode.</p> <hr/> <p>Restriction: Program must be stored and edit prompt must not be at end-of-program line.</p>
	<p>STORED EXECUTION</p> <p>Function: No effects; execution continues with next command.</p>

NOTE

The RUN command does not terminate a numeric command sequence.

START (Execute Program From Start)	<p>DIRECTLY ISSUED</p> <p>Function: Initiates Run state. Execution begins with first stored command (first command of line 000); clears subroutine return register.</p> <hr/> <p>Restriction: A program must be stored in memory.</p>
	<p>STORED EXECUTION</p> <p>Function: In the Step state, stops execution and returns to idle; next program command is first stored command; clears subroutine return register.</p> <hr/> <p>In the Run state, continues execution at the first stored command; remains in Run state; clears return register.</p>

TABLE 9-10 (CONT)
Program Entry and Execute Commands

Command	Execution
STEP (Single Line Program Execution)	Function: Goes to Step state and begins execution at next program command.
	Warning: Issued if edit prompt is at end-of-program line (remains in idle state).
	Programmability: Command not programmable; direct execution only.

NOTE

The STEP command does not terminate a numeric command sequence.

STOP (Stop)	<p>DIRECTLY ISSUED</p> <p>Function: No function; warning issued if STOP command received in idle state. If a real-time waveform acquisition command (AQR, AVG10, AVG100, AVG1000, AVG, or GND) is being executed, execution is terminated. The GPIB commands READx; SENDx; >TEXT, TEXT, and SAVE, are stopped prior to the start of data transfer. The command buffer is cleared.</p> <p>If issued while executing a program, completes current command, then stops execution (returns to idle). The next program command follows the command that was in progress when the STOP was received.</p> <p>Display: Mnemonic of command being executed (if any) when STOP command was received, and a STOP IN status message if interrupted program execution.</p>
	<p>STORED EXECUTION</p> <p>Function: Stops execution and goes into idle state. Next program command is command following the STOP.</p> <p>Display: The last executed command mnemonic (except STOP, or PAUSE) and the STOP IN status message.</p>

NOTE

The STOP command does not terminate a numeric command sequence.

SHIFT FUNCTION

Table 9-11 lists the shift function commands.

TABLE 9-11
Shift Flag Commands

Command	Execution
CLf (Clear Shift Flag)	Function: Clears shift function (f command).
f (Sets Shift Flag)	<p>Function: Shifts operation to alternate key function (printed in blue on panel above applicable keys).</p> <p>Display: Mnemonic f when shift flag set.</p> <p>Operation: The shift flag is cleared by any command, except the f command itself. If the associated key has a shift function, that function is executed. Otherwise no function is performed.</p> <p>The f key does not affect the status of numeric input if the next key activated has no shift function, or is CLf</p>

STACK

Table 9-12 lists the commands that move data within the stack, executed from the Waveform Calculator keyboard.

TABLE 9-12
Stack Control Commands

Command	Execution
CLS (Clear Stack)	Function: Clears stack; sets all registers to zero.
CLX (Clear X Register)	Function: Clears X register; pops stack as follows (refer to Fig. 6-1): <ul style="list-style-type: none"> —Copies contents of Y register to X register; —Copies contents of Z register to Y register; —Copies contents of T register to Z register; —Copies contents of W register to T register; —Original contents of W register remain in W, and are duplicated in T register.
ENTER (Enter)	Function: Terminates numeric entry if in the numeric entry state; otherwise pushes stack as follows (refer to Fig. 6-1): <ul style="list-style-type: none"> —Contents of W register are lost. —Copies contents of T register to W register; —Copies contents of Z register to T register; —Copies contents of Y register to Z register; —Copies contents of X register to Y register; —X register contents unchanged.
ROL (Roll Stack)	Function: Simultaneously rolls (or circulates) stack contents as follows (refer to Fig. 6-1): <ul style="list-style-type: none"> —Copies contents of Y register to X register; —Copies contents of Z register to Y register; —Copies contents of T register to Z register; —Copies contents of W register to T register; —Copies original contents of X register to vacated W register.
X<>Y (Interchanges X and Y)	Function: Interchanges contents of X and Y registers.

STORED WFM DISPLAY

Table 9-13 lists the commands that control the content and format of stored waveform displays.

TABLE 9-13
Stored Waveform Display Commands

Command	Execution
(Clear Display)	Function: Clears all waveforms displayed using DSW command. Operational waveform remains displayed, even though it also was displayed using DSW command.
CLW (Clear Stored Waveform)	Function: Clears stored waveform (specified in X register) from stored display, providing it was displayed using DSW command.
	Stack: Pops X register.
	Restriction: The X register must contain a constant which, when rounded to the nearest integer, is from 0 to the maximum valid waveform memory address (inclusive).
	Warning: Issued if specified waveform was not displayed with DSW command.
(Dot Display)	Function: Displays stored waveform(s) as dots in the display location of each waveform point.
DSW (Display Stored Waveform)	Function: Displays stored waveform (WFM address in X register) on stored display (in addition to other waveforms already displayed).
	Displays the waveform number (given in X register) in addition to other waveforms already displayed.
	If this waveform is already displayed, it remains displayed. Up to 8 total waveforms can be displayed using the DSW command. Then, executing DSW will pop the stack and issue a warning, but the stored waveform display won't change.

TABLE 9-13 (CONT)
Stored Waveform Display Commands

Command	Execution
DSW (cont)	<p>The operational waveform is always displayed. There could be 9 displayed waveforms if the operational waveform number has not been the operand for a DSW command.</p> <p>If the operational waveform number is in the X register when the DSW is executed, the waveform remains displayed.</p> <p>The numbers of all displayed waveforms are displayed in line 2 of the character display, preceded by the DSW mnemonic. Left-to-right sequence of numbers is the same as top-to-bottom sequence of the corresponding waveform 0 points.</p> <p style="text-align: center;">NOTE</p> <p style="text-align: center;"><i>Due to display hardware limitations, the display may show visible flicker if >2048 total points are displayed.</i></p> <hr/> <p>Stack: Pops contents of X register.</p> <hr/> <p>Restriction: The X register must contain a constant which, when rounded to the nearest integer, is from 0 to the maximum valid waveform memory address number.</p> <hr/> <p>Warning: Issued if eight waveforms already displayed with DSW.</p>
TIME (Versus Time)	<p>Function: Time (waveform point number times horizontal increment) is the horizontal axis for all displayed waveforms.</p>
VECT (Vector Display)	<p>Function: Displays stored waveform(s) as straight-line vectors joining the display locations of adjacent waveform points.</p>
VS (Waveform Versus Waveform)	<p>Function: The waveform whose address number is contained in the X register provides the horizontal axis for all displayed waveforms.</p>

TABLE 9-13 (CONT)
Stored Waveform Display Commands

Command	Execution
VS (cont)	<p>Description Of X-Y Display: The horizontal position of each displayed waveform point is the vertical graticule position of the correspondingly numbered waveform point of the horizontal waveform, in divisions, measured from horizontal graticule center.</p> <p>The mnemonic VS followed by the horizontal waveform number is displayed on line 2.</p> <p>The displayed horizontal scale factor is the same as the horizontal waveform vertical scale factor.</p> <hr/> <p>Stack: Pops X register.</p> <hr/> <p>Restriction: The X register must contain a constant which, when rounded to the nearest integer, is from 0 to the maximum valid waveform memory address number.</p>

VERTICAL POSITION

Table 9-14 lists the commands that control the vertical position of the operational waveform.

TABLE 9-14
Vertical Position Commands

Command	Execution
NOTE	
<p><i>The following keys vertically position the operational waveform.</i></p> <p><i>Each initial actuation moves the waveform by one vertical resolution increment (1/102.4 div). Keeping the key depressed longer than approximately 300 ms begins a continuous movement, in steps of one display resolution increment, for as long as the key is held down.</i></p> <p><i>These keys are programmable. Each key actuation is stored as one command, and each stored execution moves the operational waveform by one increment.</i></p>	
VPDN (Vertical Position Down)	<p>Function: Moves operational waveform downward.</p> <hr/> <p>Restriction: Vertical zero reference (VZR) must be greater than -20 divisions. All points of the operational waveform (if not 0 WFM) must remain within -20 divisions of the center horizontal graticule line.</p> <hr/> <p>Warning: Issued if operational waveform is 0 WFM, and any points are clipped at -20 divisions.</p>
VPUP (Vertical Position Up)	<p>Function: Moves operational waveform upward.</p> <hr/> <p>Restriction: Vertical zero reference (VZR) must be less than +20 divisions. All points of the operational waveform (if not 0 WFM) must remain within +20 divisions of the center horizontal graticule line.</p> <hr/> <p>Warning: Issued if operational waveform is 0 WFM, and any points are clipped at +20 divisions.</p>

WFM ACQUISITION

Waveform acquisition is the storage of real-time waveforms into the waveform memory. Table 9-15 lists the commands that control the waveform acquisition.

TABLE 9-15
Waveform Acquisition Commands

Command	Execution
AQR (Acquire Repetitive Waveforms)	<p>Function: Digitizes one or two displayed repetitive real-time waveforms, including the scale factors, into waveform memory. Acquisition stops either when at least one complete sweep has occurred and at least 99% of the points have been filled, or when prematurely terminated with a directly issued STOP command.</p>
	<p>Post Acquisition Processing: All unfilled waveform points are linearly interpolated from the adjacent filled points. Unfilled end points are set to the nearest filled point value. If no points were acquired, due to premature termination, all waveform points are set to zero, default scale factors are assigned, and the VZR is set to zero.</p>
	<p>Display: Real-time waveforms may be displayed during execution of this command in SCOPE mode. Scale factors and/or previously stored information are displayed in STORED mode.</p>
	<p>Stack: Pushes waveform memory address 0 WFM to the X register; also, to the Y register, for two waveforms.</p>
	<p>Direct Stop: A STOP command from the keyboard terminates AQR execution.</p>
	<p>Restriction: No more than two real-time waveforms may be displayed, and vertical plug-in unit(s) must not be in chop mode.</p>
<p>Warning: Issued if nonunique readout selected, default scale factor(s) assigned, more than 5% contiguous points unfilled, or command prematurely terminated with STOP.</p>	

TABLE 9-15 (CONT)
Waveform Acquisition Commands

Command	Execution
<p>400 (Acquire Single-Sweep Waveforms)</p>	<p>Function: Digitizes one or two real-time single-shot waveforms into waveform memory. Stops acquisition upon receipt of a signal from the clock generator plug-in (7B87 Time Base with Pretrigger Acquire Clock), or when the AQS ABORT is actuated.</p>
	<p>Post-Acquisition Processing: The waveform memory contains the last acquired points/waveform number of samples taken from the real-time waveform. The last point acquired is the rightmost point on the stored waveform.</p> <p>If fewer than (P/W) samples have been taken when digitizing is terminated, the filled points are right justified, and the empty points filled with the value of the first (leftmost) filled point.</p> <p>If no points have been filled when digitizing is terminated, all point values are set to \emptyset, default scale factor(s) assigned, and the VZR is set to \emptyset.</p> <p>No instrument commands are accepted during execution. Keyboard input is ignored. The effect is as though the command buffer were full, except that no warning is given.</p>
	<p>Display: Only the real-time waveform(s) displayed during execution of this command in SCOPE mode; no scale factors or stored information is displayed in STORED mode.</p>
	<p>Stack: Pushes waveform memory address \emptyset WFM to the X register; also, 1 WFM to the Y register, for two waveforms.</p>
	<p>Direct Stop: Digitizing stops when the mainframe AQS ABORT control is actuated.</p>

TABLE 9-15 (CONT)
Waveform Acquisition Commands

Command	Execution
AQS (cont)	<p>Restriction: No more than two real-time waveforms may be selected. Vertical plug-in unit(s) must not be in chop mode. The B HORIZ compartment must be selected, and must contain a properly adjusted 7B87 Time Base with Pretrigger Acquire Clock.</p>
	<p>Warning: Issued if nonunique readout is selected, default scale factor(s) assigned, more than 5% contiguous points unfilled, or if command prematurely terminated.</p>
AVG (Average Waveforms)	<p>Function: Averages one real-time waveform the number of times specified in the X register, and stores the result at waveform memory address 0 WFM. (Uses 1 WFM for working storage during execution; 1 WFM is zero valued at all points upon completion.)</p>
	<p>Post-Acquisition Processing: All unfilled waveform points are linearly interpolated from the adjacent filled points. Unfilled end points are set to the nearest filled point value. If no points were acquired due to premature termination, all waveform points are set to zero, default scale factors are assigned, and the VZR is set to zero.</p>
	<p>Algorithm: Refer to Command Algorithms at the end of this section.</p>
	<p>Display: During execution the X register displays the number of averages remaining to be done; the real-time and stored waveforms are retained on the display.</p>
	<p>Stack: Pops X register; pushes 0 to the X register.</p>
<p>Direct Stop: A STOP command from the keyboard terminates AVG execution.</p>	

TABLE 9-15 (CONT)
Waveform Acquisition Commands

Command	Execution
AVG (cont)	<p>Restriction: No more than one real-time waveform can be selected for display. The X register must contain a constant which, when rounded to the nearest integer, is from 1 to 1023 (inclusive).</p> <p>Warning: Issued if more than 5% contiguous points unfilled or if command prematurely terminated with STOP.</p>
AVG10, AVG100, AVG1000 (Average Waveform 10, 100, 1000 Times)	<p>Function: Averages real-time waveform either 10, 100, or 1000 times.</p> <p>Algorithm: Refer to Command Algorithms at the end of this section.</p> <p>Display: Real-time waveforms are displayed during execution; scale factors and/or stored information may also be displayed. The X register display shows number of averages remaining.</p> <p>Stack: Before averaging, pushes X, Y, or Z to the X register. After completion, pops the X register; pushes X to the X register.</p> <p>Direct Stop: A STOP command from the keyboard terminates the AVG10, AVG100, or AVG1000 execution.</p> <p>Restriction: No more than one real-time waveform can be selected for display.</p> <p>Warning: Issued if more than 5% contiguous points are unfilled, or if command is prematurely terminated with a STOP command.</p>

TABLE 9-15 (CONT)
Waveform Acquisition Commands

Command	Execution
<p>GND (Set Ground Reference)</p>	<p>Function: Presets real-time ground reference(s) for subsequent acquisition to the mean vertical position of the real-time trace. With one real-time trace displayed, presets ground reference for waveforms digitized into 0 WFM. With two real-time traces, presets ground references for waveforms digitized into 0 WFM and 1 WFM, respectively.</p> <p>Acquires 128-point real-time waveform as described for the AQR command. Computes the mean value, in divisions referenced to graticule vertical zero, and stores this in the ground reference register. The contents of waveform memory are not changed. If fewer than 128 points have been acquired, ground reference is set to the mean of the filled point values. If no samples are acquired, due to a forced STOP before enough sweeps have occurred, the new ground reference(s) is set to zero.</p> <p>Stack: Pushes ground reference for waveforms stored into 0 WFM, to the X register; and ground reference for waveforms stored into 1 WFM, to the Y register, for two waveforms.</p> <p>Direct Stop: A STOP command from the keyboard terminates the GND execution.</p> <p>Restriction: No more than two real-time waveforms may be selected for display. Plug-in unit(s) must not be in chop mode.</p> <p>Warning: Issued if more than 5% contiguous points are unfilled, or if GND command is prematurely terminated with a STOP command.</p>
<p>RDOU (Return Real-Time Readout Value)</p>	<p>Function: Copies contents of selected real-time readout position specified by the X register contents, to the X register. If the position selected is blank, or does not contain a valid number, a is returned. (See Waveform Storage Considerations in section 5 for details on valid readout.)</p>

TABLE 9-15 (CONT)
Waveform Acquisition Commands

Command	Execution
RDOUT (cont)	Stack: Pops the X register; pushes the readout value.
	Restriction: The X register must contain a constant which, when rounded to the nearest integer, is from 0 to 7 (inclusive).
	Warning: Issued if specified readout position is blank.

WFM FUNCTIONS

The waveform function commands compute a new waveform from the operational waveform, and the constant parameter(s) where applicable. Table 9-16 lists the waveform function commands.

TABLE 9-16
Waveform Function Commands

Command	Execution
DIFF (Differentiate)	Function: Differentiates and stores operational waveform at 0 WFM. Blanks the vertical scale factor unit.
	Algorithm: Refer to Command Algorithms at the end of this section.
	Stack: Pops X register; pushes 0 WFM to the X register.
	Restriction: The X register must contain a valid waveform memory address.

TABLE 9-16 (CONT)
Waveform Function Commands

Command	Execution
<p>HPLFT (Horizontal Position Left)</p>	<p>Function: Horizontally rotates operational waveform left.</p> <hr/> <p>Cursor Status: Determines operation as follows:</p> <p>CURSORS OFF—Rotates the waveform left by the time value in the X register.</p> <hr/> <p>ONE CURSOR ON—Rotates the waveform left by the absolute value of the horizontal coordinate (HCRD) minus the value in the X register.</p> <hr/> <p>TWO CURSORS ON—Rotates the waveform left by the HCRD time.</p> <hr/> <p>Stack: Pops X register.</p> <hr/> <p>Restriction: The X register must contain a constant which is from 0 to the maximum horizontal value of the operational waveform (inclusive).</p>
<p>HPRGT (Horizontal Position Right)</p>	<p>Function: Horizontally rotates operational waveform right.</p> <hr/> <p>Cursor Status: Determines operation as follows:</p> <p>CURSORS OFF—Rotates the waveform right by the time value in the X register.</p> <hr/> <p>ONE CURSOR ON—Rotates the waveform right by the absolute value of the horizontal coordinate (HCRD) minus the value in the X register.</p> <hr/> <p>TWO CURSORS ON—Rotates the waveform right by the HCRD time.</p> <hr/> <p>Stack: Pops X register.</p>

TABLE 9-16 (CONT)
Waveform Function Commands

Command	Execution
HPRGT (cont)	<p>Restriction: The X register must contain a constant which is from 0 to the maximum horizontal value of the operational waveform (inclusive).</p>
HXPB (Horizontally Expand)	<p>Function: Horizontally expands operational waveform.</p> <hr/> <p>Cursor Status: Determines operation as follows:</p> <hr/> <p>CURSORS OFF</p> <p>Operation: Magnifies operational waveform (by value in X register) from left edge of graticule; 0 point remains fixed.</p> <hr/> <p>Stack: Pops X register; pushes 0 WFM to the X register.</p> <hr/> <p>Restriction: The Y register must contain a valid waveform memory address. The X register must contain a constant greater than 0.</p> <hr/> <p>Warning: Issued if the X register contains a constant which is less than one.</p> <hr/> <p>ONE CURSOR ON</p> <p>Operation: Magnifies operational waveform (by value in X register) from right of cursor. Cursor remains at same location relative to the graticule.</p> <hr/> <p>Stack: Pops X register; pops Y register; pushes 0 WFM to the X register.</p> <hr/> <p>Restriction: The Y register must contain a valid waveform memory address. The X register must contain a constant greater than 0.</p> <hr/> <p>Warning: Issued if the X register contains a constant which is less than 10/(distance from Cursor 1 to the right graticule edge, in divisions).</p>

TABLE 9-16 (CONT)
Waveform Function Commands

Command	Execution
HXPD (cont)	<p>TWO CURSORS ON Operation: Magnifies portion of waveform between cursors to fill the display screen. Cursors remain at same location relative to graticule.</p> <hr/> <p>Stack: Pops X register; pushes \dots to the X register.</p> <hr/> <p>Restriction: The X register must contain a valid waveform memory address.</p> <hr/> <p>Warning: Issued if \dots equals \dots.</p> <hr/> <p>Algorithm: Refer to Command Algorithms at the end of this section.</p> <hr/> <p>Horizontal Scale Factor: This result is stored at \emptyset WFM. In all cases, horizontal scale factor is divided by the expansion ratio to keep relative horizontal waveform values unchanged.</p> <hr/> <p>Vertical Scale Factor: Autoscaling is disabled. Original scale factor and vertical zero are maintained.</p>
ITRP (Interpolate)	<p>Function: Replaces portion of operational waveform, between two specified points, with a straight line. The result is stored in waveform memory address \emptyset WFM, which then becomes the operational waveform.</p> <hr/> <p>Cursor Status: Determines operation as follows:</p> <hr/> <p>CURSORS OFF Operation: The end point horizontal locations are specified by the values in the X and Y registers, in scale factor units.</p> <hr/> <p>Restriction: The X and Y registers must contain a constant from \emptyset to the maximum horizontal coordinate of the operational waveform.</p>

TABLE 9-16 (CONT)
Waveform Function Commands

Command	Execution
ITRP (cont)	<p>ONE CURSOR ON</p> <p>Operation: The end point horizontal locations are specified by the value in the X register and the Cursor 1 location.</p> <hr/> <p>Restriction: The X register must contain a constant from 0 to the maximum horizontal coordinate of the operational waveform.</p>
	<p>TWO CURSORS ON</p> <p>Operation: The end points are the cursor locations.</p> <hr/> <p>Stack: Pops X register; pushes 0 WFM to the X register.</p> <hr/> <p>Restriction: The X register must contain a valid waveform memory address.</p>
	<p>Vertical Scale Factor: Autoscaling is disabled. The existing vertical scale factor and vertical zero are retained.</p>
INTG (Integrate)	<p>Function: Integrates the operational waveform. The result is stored in waveform memory address 0 WFM, which then becomes the new operational waveform. Blanks the vertical scale factor unit.</p>
	<p>Algorithm: Refer to Command Algorithms at the end of this section.</p>
	<p>Stack: Pops X register; pushes 0 WFM to the X register.</p> <hr/> <p>Restriction: The register must contain a valid waveform memory address.</p>
ORD (Return Ordinate Value)	<p>Function: Returns vertical ordinate value of operational waveform (in scale factor units) at horizontal location indicated in X register, to the X register.</p>

TABLE 9-16 (CONT)
Waveform Function Commands

Command	Execution
ORD (cont)	<p>Stack: Pops X register; pushes result to X register.</p> <p>Restriction: The X register must contain a constant from 0 to the maximum horizontal value of the operational waveform (inclusive).</p>
<p>>ORD (Set Ordinate Value)</p>	<p>Function: Sets the operational waveform horizontal location indicated in the X register to the vertical value in the Y register. The result is stored in 0 WFM, which then becomes the operational waveform.</p> <p>Stack: Pops contents of X and Y registers; pushes previous contents of X register.</p> <p>Restriction: The Y register must contain a constant. The X register must contain a constant from 0 to the maximum horizontal coordinate of the operational waveform (inclusive).</p>
SMOOTH (Smooth)	<p>Function: Averages operational waveform by an amount determined by the number of divisions (between 0 and 2) entered in X register. Resultant waveform is stored at waveform memory address 0 WFM.</p> <p>Algorithm: Refer to Command Algorithms at the end of this section.</p> <p>Stack: Pops X register; pops Y register; pushes 0 WFM to the X register.</p> <p>Vertical Scale Factor: Autoscaling is disabled. Vertical scale factor and vertical zero of the original waveform are maintained.</p> <p>Restriction: The Y register must contain a valid waveform memory address. The X register must contain a constant from 0 to 2 (inclusive).</p>

WFM PARAMETERS

The waveform parameter commands compute various constant parameters of the operational waveform. There are two parameter groups: The vertical unit parameters which return vertical axis values, and the pulse parameters which return horizontal axis values. Table 9-17 lists the waveform parameter commands.

The following vertical waveform parameter commands are computed using waveform point values in scale factor units. Cursor status and position affect the calculation of all the vertical parameters as follows:

CURSORS OFF. The function spans all waveform points.

ONE CURSOR ON. The function spans from (and includes) the cursor point to the right end of the waveform.

TWO CURSORS ON. The function spans between (and includes) the cursor points.

TABLE 9-17
Waveform Parameter Commands

Command	Execution
VERTICAL PARAMETERS	
AREA (Returns Area)	<p>Function: Returns area under all spanned waveform points to the X register.</p>
	<p>Algorithm: Refer to Command Algorithms at the end of this section.</p>
	<p>Stack: Pushes value to X register.</p>
ENERGY (Returns Energy)	<p>Function: Returns the squared area under all spanned waveform points to the X register.</p>
	<p>Algorithm: Refer to Command Algorithms at the end of this section.</p>
	<p>Stack: Pushes value to X register.</p>
MAX (Returns Maximum Value)	<p>Function: Returns waveform maximum (most positive) value to the X register.</p>
	<p>Stack: Pushes value to X register.</p>

TABLE 9-17 (CONT)
Waveform Parameter Commands

Command	Execution
VERTICAL PARAMETERS (Cont)	
MEAN (Returns Mean Value)	Function: Computes algebraic mean value of all spanned points, and returns result to the X register.
	Algorithm: Refer to Command Algorithms at the end of this section.
	Stack: Pushes value to X register.
MID	Function: Returns middle value $[(MAX + MIN)/2]$ to the X register.
	Stack: Pushes value to X register.
MIN (Returns Minimum Value)	Function: Returns waveform minimum point (most negative) value to the X register.
	Stack: Pushes value to X register.
P-P (Returns Peak-to-Peak Value)	Function: Returns peak-to-peak (MAX - MIN) value to the X register.
	Stack: Pushes value to X register.
RMS (Returns Root-Mean-Square Value)	Function: Returns root-mean-square value of all spanned points to the X register.
	Algorithm: Refer to Command Algorithms at the end of this section.
	Stack: Pushes value to X register.

PULSE PARAMETERS

NOTE

For all pulse parameter commands except PER and FREQ the left end of the spanned interval (as specified either by the start of the waveform or by Cursor 1, if on) defines the 0% vertical level (baseline). The 100% vertical level (pulse top) is defined by the end of the interval (specified by the end of the waveform or by Cursor 2, if on).

TABLE 9-17 (CONT)
Waveform Parameter Commands

Command	Execution
PULSE PARAMETERS (Cont)	
DELAY (Returns Delay)	Function: Returns the time from Cursor 1 to the last 50% point before Cursor 2, to the X register.
	Stack: Pushes DELAY time to the X register.
	Restriction: <i>WORD</i> must not be within: $\pm(6E-4) * (\text{vertical scale factor})$.
(Returns Fall Time)	Function: Returns the time between the 90% and 10% points adjacent to the first 50% point to the right of Cursor 2.
	Stack: Pushes <i>FALL</i> time to the X register.
	Restriction: Cursor 2 must be on. The operational waveform must cross the 90% and 10% levels after Cursor 2. <i>WORD</i> must not be within: $\pm(6E-4) * (\text{vertical scale factor})$.
(Returns Frequency)	Function: Returns a crossing frequency to the X register.
	Algorithm: Refer to Command Algorithms at the end of this section.
	Stack: Pops X register; pushes the <i>FREQ</i> value to the X register.
Restriction: The X register must contain a constant. The operational waveform must cross the level specified in the X register twice in the same direction.	
PER (Returns Period)	Function: Returns time in horizontal scale factor units between the first and second crossings, in the same direction, of the operational waveform across the level in the X register.
	Algorithm: Refer to Command Algorithms at the end of this section.

TABLE 9-17 (CONT)
Waveform Parameter Commands

Command	Execution
PULSE PARAMETERS (Cont)	
PER (cont)	Stack: Pops X register; pushes PER value to the X register.
	Restriction: The X register must contain a constant. The operational waveform must cross the level in the X register at least twice in the same direction (between cursors, if on).
RISE (Returns Rise Time)	Function: Returns the time between 10% and 90% points adjacent to the last 50% point before (to the left of) Cursor 2.
	Stack: Pushes RISE time to the X register.
	Restriction: VCRD must not be within: $\pm(6E-4) * (\text{vertical scale factor})$.
WIDTH (Returns Width)	Function: Returns time between closest 50% points to the left and right of Cursor 2 to the X register.
	Stack: Pushes WIDTH value to the X register.
	Restriction: Cursor 2 must be on. The operational waveform must cross the 50% level after Cursor 2. VCRD must not be within: $\pm(6E-4) * (\text{vertical scale factor})$.

WFM SCALING

Table 9-18 lists the commands that provide access to the operational waveform scale factors and zero location.

TABLE 9-18
Waveform Scaling Commands

Command	Execution
HSCL (Return Horizontal Scale Factor)	Function: Copies operational waveform horizontal scale factor to the X register.
	Stack: Pushes value to X register.
>HSCL (Set Horizontal Scale Factor)	Function: Copies contents of X register to the operational waveform horizontal scale factor.
	Restriction: The X register must contain a constant greater than zero. The operational waveform must not be displayed with the VS command.
VSCL (Return Vertical Scale Factor)	Function: Copies operational waveform vertical scale factor (size of each vertical graticule division) to the X register.
	Stack: Pushes value to X register.
>VSCL (Set Vertical Scale Factor)	Function: Copies contents of the X register to the operational waveform vertical scale factor. Does not alter stored waveform values relative to graticule. Displayed vertical scale unit not changed.
	Restriction: The X register must contain a constant greater than zero.
VXPD (Vertically Expand)	Function: Expands the operational waveform vertically about the screen center (by the value in the X register); changes the vertical scale factor by the reciprocal of the absolute value in the X register to keep the waveform values unchanged. Negative values in the X register invert the waveform about screen center.
	Stack: Pops X register.

TABLE 9-18 (CONT)
Waveform Scaling Commands

Command	Execution
VXPD (cont)	<p>Restriction: The X register must contain a constant. The resulting vertical zero reference of the operational waveform must be within +20 to -20 divisions. If the operational waveform is not from 0 WFM all resulting waveform points must be within 20 divisions from the VZR or from all other waveform points.</p> <p>Warning: Issued if operational waveform is from 0 WFM and at least one point is clipped at ±10 divisions from the center horizontal graticule line.</p>
VZR (Return Vertical Zero Reference)	<p>Function: Copies operational waveform vertical zero reference (in graticule divisions relative to center screen) to the X register.</p> <p>Stack: Pushes X register.</p>
>VZR (Set Vertical Zero Reference)	<p>Function: Moves operational waveform vertically, so that its vertical zero reference is the value (in divisions) in the X register.</p> <p>Restriction: The X register must contain a constant from -20 to +20 (inclusive). All points of the operational waveform (if not from 0 WFM) must be within +20 and -20 divisions.</p> <p>Warning: Issued if the operational waveform is from 0 WFM, and any point is clipped at ±20 divisions from the center horizontal graticule line.</p>

GPIB COMMANDS

Table 9-19 lists the commands that can be executed through the external interface only, as they have no corresponding keyboard pushbuttons. Refer to Section 7, GPIB Information, for sample programs using these commands.

TABLE 9-19
GPIB Only Commands

Command	Execution
CEROFF CERON	Function: Enables/disables local request for service due to external command error.
ERR?	Function: Outputs error status: "ERR 00" if no error exists, or "ERR 01" if an error does exist.
EXROFF EXRON	Function: Enables/disables local request for service due to instrument command execution error.
ID?	Function: Outputs a copy of the 7854 identification display to the GPIB. ("ID TEK/7854.V79.I,XX.YY,ZK" where XX is the ROM version, YY is the ROM revision, and Z is 2, 4, or 8, indicating the number of kilobytes of RAM installed.)
IOCOFF IOCON	Function: Enables/disables request for service due to initiated instrument I/O command.
OPCOFF OPCON	Function: Enables/disables local request for service due to return to idle state (except error stop).
REMOFF REMON	Function: Enables/disables request for service due to execution of the Service Request (RQS) command.
RQSOFF (Service Request Off)	Function: Disables all service requests, except power on.
RQSON (Service Request On)	Function: Selects full-service-request capability.

TABLE 9-19 (CONT)
 GPIB Only Commands

Command	Execution
SRQ?	<p>Function: Outputs a copy of the bottom line of the calculator display. ("SRQ XXXXXXXXXXXXXXXX XXXXXXXXXXXXXXXXXXXX" where XXXX... is the bottom line of the display.)</p>
TEXT (Output Displayed Characters)	<p>Function: Sends a data record to the external interface containing an ASCII representation of all 16 lines of the Execute mode character display. If the SCOPE display mode is selected, the real-time scale factors are sent.</p>
	<p>Restriction: The GPIB interface must be properly selected.</p>
	<p>Programmability: This command is programmable; therefore, it cannot be used to output program text.</p>
>TEXT (Input Characters To Display)	<p>Function: Inputs a record (up to 12 lines, maximum of 40 characters each) of ASCII characters from the external interface, and displays it as lines 3 through 14 on the Execute mode display.</p>
	<p>Restriction: The GPIB interface must be properly selected.</p>
	<p>Warning: Issued if line is more than 40 characters long, or more than 12 lines.</p>
	<p>Programmability: This command is programmable.</p>

MESSAGES AND ALGORITHMS

Command Error and Warning messages are defined in the tables below. Command Algorithms are provided, where appropriate, at the end of this section.

ERROR AND WARNING MESSAGES

Some commands have associated restrictions on the type and/or value of their operands. These conditions are checked for each command; any error terminates further execution, and displays an error message.

With some commands, the state of the instrument and/or the value of their operands may cause the result to be other than expected. In these cases, the command is executed, followed by a displayed warning message. Tables 9-20 and 9-21 list the errors and warnings, the command(s) affected, and the possible causes.

TABLE 9-20
Error Messages

Displayed Message	Command(s) Affected	Possible Causes
AQR ERROR	AQR	<ul style="list-style-type: none"> a. More than two real-time waveforms are selected. b. Plug-in unit is in chop mode.
AQS ERROR	AQS	<ul style="list-style-type: none"> a. More than two real-time waveforms are selected. b. Vertical plug-in unit is in chop mode. c. The B HORIZ compartment is not selected or does not contain a properly adjusted 7B87 Time Base with Pretrigger Acquire Clock.
AVG ERROR	AVG	<ul style="list-style-type: none"> a. More than one real-time waveform is selected. b. The X register does not contain a constant which, when rounded to the nearest integer, is from 1 to 1023 (inclusive).

TABLE 9-20 (CONT)
Error Messages

Displayed Message	Command(s) Affected	Possible Causes
AVG ERROR	AVG10, AVG100, AVG1000	a. More than one real-time waveform is selected.
No Message	CHS	a. The X register does not contain a constant.
CLL ERROR	CLL	a. Command issued in program Execute mode. b. Edit prompt is at end-of-program.
CLM ERROR		a. Command issued in program Execute mode.
CLW ERROR	CLW	a. The X register does not contain a constant which, when rounded to the nearest integer, is from 0 to the maximum valid waveform memory address number (inclusive).
CNS ERROR	CNS	a. The X register does not contain a constant which, when rounded to the nearest integer, is from 0 to 49 (0 to 99 with Option 2D ¹), inclusive.
CRS ERROR		a. The X register does not contain a constant which, when rounded to the nearest integer, is from 0 to 49 (0 to 99 with Option 2D ¹), inclusive.
CRS1 ERROR	CRS1<, CRS1>, CRS2<, CRS2>	a. Specified cursor is not on.
DEL ERROR	DELAY	a. is within: $\pm(6E-05) \times$ (vertical scale factor).
DEL1 ERROR		a. The X register does not contain a valid waveform memory address.

¹ Applies only to instruments with serial numbers below B085121. For instruments with serial number B085121 and above, features previously provided by Option 2D are standard.

TABLE 9-20 (CONT)
Error Messages

Displayed Message	Command(s) Affected	Possible Causes
	DSW	a. The X register does not contain a constant which, when rounded to the nearest integer, is from 0 to the maximum valid waveform memory address number.
	FALL	a. Cursor 2 is not on. b. The operational waveform does not cross the 90% and 10% levels after Cursor 2. c. VCRD is within: $\pm(6E-04) *$ (vertical scale factor).
	FREQ	a. The X register does not contain a constant. b. The operational waveform does not cross the level specified in the X register twice in the same direction.
	GND	a. More than 2 real-time waveforms are selected. b. Plug-in unit is in chop mode.
	GOTO	a. The X register does not contain a constant which, when rounded to the nearest integer, is from 0 to 999 (inclusive).
	GSB	a. The X register does not contain a constant which, when rounded to the nearest integer, is from 0 to 999 (inclusive). b. More than 10 levels of nesting entered.
	HCRD	a. Cursor(s) are not on.

TABLE 9-20 (CONT)
Error Messages



Displayed Message	Command(s) Affected	Possible Causes
HC ERROR	>HCRD	<p>a. Cursor(s) are not on.</p> <p>b. The operational waveform is displayed with .</p> <p>c. The X register does not contain a constant which is greater than 0.</p>
HPL ERROR	HPLFT	a. The X register does not contain a constant which is from 0 to the maximum horizontal value of the operational waveform (inclusive).
HPR ERROR	HPRGT	a. The X register does not contain a constant which is from 0 to the maximum horizontal value of the operational waveform (inclusive).
HS ERROR	>HSCL	<p>a. The X register does not contain a constant greater than 0.</p> <p>b. The operational waveform is displayed with .</p>
HXP ERROR	HXPD (Cursors Off) or (Cursor 1 On)	<p>a. The Y register does not contain a valid waveform memory address.</p> <p>b. The X register does not contain a constant greater than 0.</p>
	HXPD (Both Cursors On)	a. The X register does not contain a valid waveform memory address.
INT ERROR	INTG	a. The X register does not contain a valid waveform memory address.
ITR ERROR	ITRP (Cursors Off)	a. The X or Y registers do not contain constants from 0 to the maximum horizontal coordinate of the operational waveform.

TABLE 9-20 (CONT)
Error Messages

Displayed Message	Command(s) Affected	Possible Causes
(cont)	ITRP (Cursor 1 On)	a. The X register does not contain a constant from 0 to the maximum horizontal coordinate of the operational waveform.
	ITRP (Both Cursors On)	a. The X register does not contain a valid waveform memory address.
	LPL	a. The X register does not contain a constant which, when rounded to the nearest integer, is from 0 to 99 (inclusive). b. The label specified in the X register does not occur in the stored program.
	LNA	a. Command issued in program Execute mode. b. Command not followed by two digit-entry commands or the CLL or CLP command.
	NEXT	a. Command issued in program Execute mode. b. Edit prompt is at end-of-program.
	ORD	a. The X register does not contain a constant from 0 to the maximum horizontal value of the operational waveform (inclusive).
	ORD	a. The Y register does not contain a constant. b. The X register does not contain a constant from 0 to the maximum horizontal coordinate of the operational waveform (inclusive).

TABLE 9-20 (CONT)
Error Messages

Displayed Message	Command(s) Affected	Possible Causes
PER	PER	<p>a. The X register does not contain a constant.</p> <p>b. The operational waveform does not cross the level in the X register at least twice in the same direction (between cursors, if on).</p>
PNT	PNT	<p>a. The X register does not contain a constant which, when rounded to the nearest integer, is from 0 to $[(P/W)-1]$, inclusive.</p>
PNT	PNT	<p>a. The Y register does not contain a constant.</p> <p>b. The (contents of the Y register) divided by the (vertical scale factor) is not within waveform data vertical range.</p> <p>c. The X register does not contain a constant which, when rounded to the nearest integer, is from 0 to $[(P/W)-1]$, inclusive.</p>
PREV	PREV	<p>a. Command issued in program Execute mode.</p> <p>b. Edit prompt is at line 000.</p>
P W	P W	<p>a. The X register does not contain a constant which, when rounded to the nearest integer, is either 128, 256, 512, or 1024.</p>
READx	READx	<p>a. GPIB interface not properly selected.</p>
RDOUT	RDOUT	<p>a. The X register does not contain a constant which, when rounded to the nearest integer, is from 0 to 7 (inclusive).</p>

TABLE 9-20 (CONT)
Error Messages

Displayed Message	Command(s) Affected	Possible Causes
RIS ERROR	RISE	a. VCRD is within: $\pm(6E-05) *$ (vertical scale factor).
RTN ERROR	RTN	a. Return register not set.
RUN ERROR	RUN	a. No stored program. b. Edit prompt is at end-of-program.
SAV ERROR	SAVE	a. No stored program. b. Edit prompt is at end-of-program. c. GPIB interface not properly selected.
SEN ERROR	SEND x	a. GPIB interface not properly selected.
SMO ERROR	SMOOTH	a. The Y register does not contain a valid waveform memory address. b. The X register does not contain a constant from 0 to 2 inclusive.
STA ERROR	START	a. No stored program.
TEX ERROR	TEXT	a. GPIB interface not properly selected.
TE ERROR	>TEXT	a. GPIB interface not properly selected.
VCR ERROR	VCRD	a. Cursor(s) are off.
VC ERROR	VCRD	a. Cursor(s) are off. b. The operational waveform does not touch or cross the specified level within the allowed cursor movement range.

TABLE 9-20 (CONT)
Error Messages

Displayed Message	Command(s) Affected	Possible Causes
VZ ERROR	VPDN	a. VZP is at +20 or -20 divisions.
VW ERROR	VPUP	b. All points of the operational waveform (if not from 0 WFM) will not remain within ±20 divisions of the center horizontal graticule line.
VX ERROR	VS	a. The X register does not contain a constant which, when rounded to the nearest integer, is from 0 to the maximum valid waveform memory address number.
VY ERROR	>VSCL	a. The X register does not contain a constant greater than 0.
VZ ERROR	VXPD	a. The X register does not contain a constant. b. Resulting waveform would not be within +20 to -20 divisions. c. All waveform points will not be within 20 divisions from the or from all other waveform points.
VZ ERROR	>VZR	a. The X register does not contain a constant from -20 to +20 (inclusive). b. All points of the operational waveform (if not from 0 WFM) will not be within +20 and -20 divisions.
WFM ERROR	WFM	a. The X register does not contain a constant which, when rounded to the nearest integer, is from 0 to the maximum valid waveform memory address number (inclusive).

TABLE 9-20 (CONT)
Error Messages

Displayed Message	Command(s) Affected	Possible Causes
		a. The Y register does not contain a valid waveform memory address. b. The X register does not contain a constant which, when rounded to the nearest integer, is from 0 to the maximum valid waveform memory address number (inclusive).
	WIDTH	a. Cursor 2 is off. b. The operational waveform does not cross the 50% level after Cursor 2. c. Cursor 2 is within: $\pm(6E-04) *$ (vertical scale factor).

TABLE 9-21
Warning Messages

Displayed Message	Command(s) Affected	Possible Causes
	AQR	a. Nonunique readout selected. b. Default scale factor(s) assigned. c. More than 5% contiguous points unfilled. d. Command prematurely terminated with STOP.
		a. More than 5% contiguous points unfilled.
	AVG, AVG10, AVG100, AVG1000	a. More than 5% contiguous points unfilled. b. Command prematurely terminated with STOP.

TABLE 9-21 (CONT)
Warning Messages

Displayed Message	Command(s) Affected	Possible Causes
CLW WARNING	CLW	a. Specified waveform was not displayed with DSW.
CRS WARNING	CRS1> CRS2>	a. Cursor at end of operational waveform.
	CRS1<	a. Cursor at start of operational waveform.
	CRS2<	a. Cursor 2 at Cursor 1.
DSW WARNING	DSW	a. Eight waveforms already displayed with DSW.
No Message	EEX	a. EEX command issued during exponent entry.
GND WARNING	GND	a. More than 5% contiguous points unfilled. b. Command prematurely terminated with STOP.
GOTO WARNING	GOTO	a. The X register contains a constant greater than the last stored program line number.
GSB WARNING	GSB	a. The X register contains a constant greater than the last stored program line number.
HC WARNING	HCOR	a. The value in the X register represents a position beyond the right graticule edge.
HXP WARNING	HXP (Cursors Off)	a. The X register contains a constant which is less than 1.
	HXP (Cursor 1 On)	a. The X register contains a constant which is less than: $10 / (\text{distance from Cursor 1 to the right graticule edge, in divisions})$.

TABLE 9-21 (CONT)
Warning Messages

Displayed Message	Command(s) Affected	Possible Causes
(cont)	HXPD (Both Cursors On)	a. HCRD equals 0.
	LN	a. The constant in the X register is either 0 or negative. b. At least one point of the waveform referenced in the X register is either 0 or negative.
No Message	NEXT	a. New program line is started.
	RDOUT	a. Specified readout position is blank or does not contain a valid readout.
	SORT	a. The constant in the X register is negative. b. At least one point of the waveform referenced in the X register is negative.
	STEP	a. Edit prompt is at end-of-program.
	STOP	a. STOP command issued as part of a stored program.
	STOP	a. Direct STOP command issued during execution of a stored program.
	>TEXT	a. Line too long, too many characters, or too many lines.
	VPDN	a. Operational waveform is from 0 WFM and at least one point would be below -20 divisions.
	VPUP	a. Operational waveform is from 0 WFM and at least one point would be above +20 divisions.

TABLE 9-21 (CONT)
Warning Messages

Displayed Message	Command(s) Affected	Possible Causes
VXF WARNING	VXPD	a. Operational waveform is from \emptyset WFM and at least one point would be more than 10 divisions from the center horizontal graticule line.
VZ WARNING	>VZR	a. Operational waveform is from \emptyset WFM and at least one point would be more than 20 divisions from the center horizontal graticule line.
No Message	\emptyset -9	a. More than 12 (digits plus decimal point) issued as mantissa.
No Message	.	a. More than one decimal point issued during mantissa entry. b. Decimal point issued during exponent entry.
+ WARNING	+	a. Both operands are waveforms with differing horizontal scale factors.
- WARNING	-	
* WARNING	*	
/ WARNING	/	a. Both operands are waveforms with differing horizontal scale factors. b. The X register contains \emptyset . c. At least one point of the operational waveform is equal to \emptyset .

COMMAND ALGORITHMS

The algorithms listed below describe the operation of the associated 7854 commands. Algorithm terms are defined in Figure 9-5.

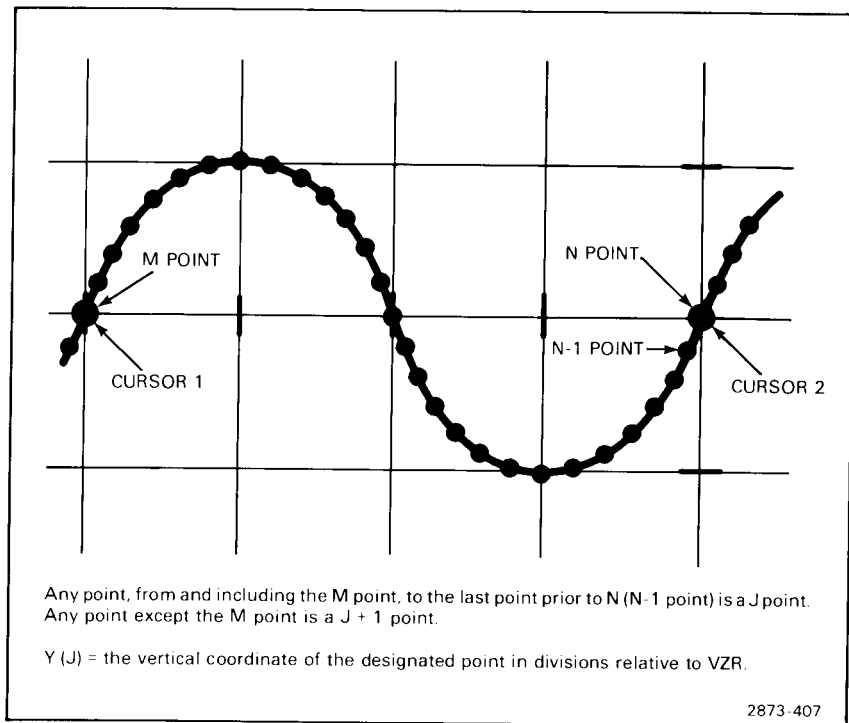

Figure 9-5. Algorithm terms defined.

AREA

Algorithm—If M and N are the interval end-points ($M < N$), then:

$$\text{AREA} = \sum_{J=M}^{N-1} ([Y(J+1) + Y(J)]/2) * (\text{horizontal increment})$$

For one point ($N=M$), $\text{AREA} = \emptyset$.

Where: horizontal increment = horizontal time increment between two adjacent points.

This is equivalent to estimating the area by linear interpolation between points (Trapezoidal rule).

AVG

Acquires the real-time waveform, then repeatedly reacquires it, accumulating new data, point-by-point, into corresponding points of the averaged waveform. At each point, the process is characterized by the stable averaging formulas given below:

Let $Y_0(N)$ = averaged stored waveform value after N cycles
 $Y_1(N)$ = new data acquired during acquisition N.

Initially $Y_0(0) = 0$

After cycle N, $Y_0(N) = Y_0(N-1) + [Y_1(N) - Y_0(N-1)]/N$

Continue until N = Value in X register.

It can be shown that this process is equivalent to the simple additive average:

$$Y_0(N) = \sum_{J=1}^N [Y_1(J)]/N$$

Stable averaging is used because, in the averaged data, the stable component (repeating from cycle to cycle in the raw data) does not grow in size. After every cycle, the averaged data has the values it should have if the process were complete at that time. Thus, the user can observe the progress of the process, and has the option of early manual termination.

Practical Operation—The practical details and specifications described in connection with repetitive acquisition apply to every digitized point during averaging.

A modified stable averaging formula is used:

$$Y_0(N) = Y_0(N-1) + [Y_1(N) - Y_0(N-1)]/M$$

Where $M = 2^{\text{exp}\{\text{Int} [\text{Log}_2 (1.443 * N)]\}}$
 Int = integer value

This increases computing speed, but the influence of all samples is not equal in the final result, leading to slightly less noise rejection (approximately 0.7 dB less for random Gaussian noise).

An average value of N is used to compute M at any stage of the process:

$$N = \frac{\text{total processed points}}{\text{points per waveform}}$$

Due to the random sequence of new point acquisition more samples of some points will be processed than of others. The standard deviation on the actual number of samples at any given point is:

$$S = \sqrt{N}$$

This method avoids keeping count of each individual point; but it leads to a variation in noise rejection from point to point, which effectively adds an extra noise component.

DIFF

Ideal Algorithm—Resulting waveform = d (operational waveform)/dx.

Practical Algorithm—The continuous operand waveform is conceptually derived from the discrete operational waveform by linear interpolation between the stored data points. Then, the differential coefficient at each data point is defined as the mean slope of the adjacent segments:

$$\begin{aligned} &\text{for } N = 1 \text{ to } (M-1) \\ \text{diff}(N) &= ([Y(N+1) - Y(N-1)]/2) / (\text{horizontal increment}) \\ \text{diff}(\emptyset) &= [Y(1) - Y(\emptyset)] / (\text{horizontal increment}) \\ \text{diff}(M) &= [Y(M) - Y(M-1)] / (\text{horizontal increment}) \end{aligned}$$

where:

- diff(N) = differential coeff at point N.
- Y(N) = operational waveform value at point N.
- M = points per waveform minus one.
- Horizontal increment = horizontal time increment between two adjacent points.

For the general point, this is equivalent to the slope of the parabola passing thru the corresponding point of the operational waveform and its two adjacent points.

ENERGY

Algorithm—If M and N are the interval end-points (M < N), then:

$$\text{ENERGY} = \sum_{J=M}^{N-1} ([Y(J+1)^2 + Y(J)^2]/2) * (\text{horizontal increment})$$

For one point (N=M), ENERGY = \emptyset .

where:

- Horizontal increment = horizontal time increment between two adjacent points.

This is equivalent to squaring all waveform points, then estimating the area using linear interpolation between points (Trapezoidal rule).

FREQ

Algorithm—Computes period as described for PER command, then computes its reciprocal.

HXPD

Algorithm—For each waveform point which will become part of the expanded waveform, the new horizontal location is computed, and that value placed at the nearest point location. Intervening data is generated by linear interpolation.

In the expanded waveform, values of the unexpanded points are stored in the actual point location closest to the computed location. This generates a "random" perturbation of the expanded waveform, proportional to the slope at the moved points.

Interpolation is used to fill intervening points. Points outside the interval bounded by the original data values are filled with the value of the closest original point. Actual data, which may have been present at other than stored points, generally would behave differently.

INTG

Ideal Algorithm— $\text{INT}(x) = \int_0^x (\text{operational waveform}) dx$

Practical Algorithm—The continuous integrand waveform is conceptually derived from the operational waveform by linear interpolation between the stored points. Then, the area to point N of the integral waveform is calculated using the trapezoidal rule:

$$\text{INT}(0) = 0$$

for N = 1 to (points per waveform - 1):

$$\text{INT}(N) = [Y(0)/2 + Y(1) + Y(2) + \dots + Y(N)/2] * (\text{horizontal increment}).$$

where:

INT(N) = value of integrated waveform point N.

Y(N) = value of integrand waveform point N.

Horizontal increment = horizontal time increment between two adjacent points.

MEAN

Algorithm—If M and N are the interval end-points (M < N), then:

$$\text{MEAN} = \frac{\sum_{J=M}^{N-1} [Y(J+1) + Y(J)]}{2(N-M)}$$

For one point (N=M), MEAN = Y(N)

This is equivalent to AREA ÷ (horizontal extent).

PER

Algorithm—Computes time between first crossing of operational waveform across level (value in X register) to next crossing in same direction. Searching starts at the left end of the interval.

Any point where the waveform touches the level (value in X register) but does not cross it is detected as a crossing.

RMS

Algorithm—If M and N are the interval end-points (M < N), then:

$$\text{RMS} = \text{sqrt} \left\{ \sum_{J=M}^{N-1} [Y(J+1)^2 + Y(J)^2] / 2(N-M) \right\}$$

For one point (N=M), RMS = absolute value of Y(N).

SMOOTH

Ideal Algorithm—The waveform is convolved with a square pulse of width (equal to the value in the X register) in graticule divisions, centered about time zero.

Practical Operation—The pulse width (value in X register) in divisions is converted to the equivalent number of horizontal increments, which is then rounded up to the nearest odd number S.

For each point of the new waveform: the corresponding point of the old waveform, and the (S-1)/2 points on either side of it, are averaged and the value stored as the new point.

Near the ends of the waveform, the above method requires up to (S-1)/2 nonexistent points beyond the ends. The values of the corresponding end points are used for these nonexistent points.

Errors—The actual width of the pulse differs from the specified width; in general, an error of up to ±1 horizontal increment could occur.

The method of extending the waveform ends is arbitrary, and the results within a pulse width of the ends must be interpreted in the light of the method. Actual data which may have existed beyond the ends would generally give a different result, but it is unknown to the calculator.

Appendix A- Command Index

A

ABS (Absolute Value)

demonstration of, **xxvi; 6-15,40**
discussion of, **1-13; 6-12,15,37,40; 9-11**
location of, **Fig. D block 2**
usage of, **6-15,40,93**

AQR (Acquire Repetitive Waveform)

demonstration of, **5-4; 6-24**
discussion of, **xxii,xxx1; 1-13; 5-1,4,5; 6-20,24; 9-41**
location of, **Fig. B block 6; Fig. D block 15**
restrictions for, **5-6; 6-25; 9-41,60**
usage of, **5-4,8; 6-24,38,39,44,46,47,48,63,72,112,115,125**
warnings issued for, **5-4,5; 6-24; 9-41,68**

AQS (Acquire Single-Sweep Waveform)

demonstration of, **5-12**
discussion of, **xxii, xxx1; 1-13; 5-1,4,12,13,14,20; 9-42**
location of, **Fig. B block 6; Fig. D block 15**
maximum sweep rate, **2-5**
restrictions for, **5-14, 9-43,60**
usage of, **5-12**
warnings issued for, **5-13; 9-43,68**

AREA (Return Area)

accuracy of, **2-12**
algorithm for, **9-72**
demonstration of, **5-26**
discussion of, **xx,xxviii; 1-13; 5-22,26; 9-52**
location of, **Fig. B block 1; Fig. D block 5**
usage of, **5-26**

AVG (Average)

algorithm for, **9-73**
demonstration of, **6-28**
discussion of, **xxx1; 1-13; 5-10,11; 6-20,28; 9-43**
location of, **Fig. D block 15**
restrictions for, **5-11; 6-28; 9-44,60**
usage of, **6-28,98,101**
warnings issued for, **5-11; 6-28; 9-44,68**

AVG10 (Average 10 Times)

algorithm for, **9-73**
discussion of, **xxii; 1-13; 5-4,10,11; 6-20; 9-44**
location of, **Fig. B block 6**
restrictions for, **5-11; 9-44,61**
usage of, **5-17,23; 6-52,53,83,98,102**
warnings issued for, **5-11; 9-44,68**

Appendix A—Command Index

AVG100 (Average 100 Times)

- algorithm for, **9-73**
- demonstration of, **5-10**
- discussion of, **xxii; 1-13; 5-4,10,11; 6-20; 9-44**
- location of, **Fig. B block 6**
- restrictions for, **5-11; 9-44,61**
- usage of, **5-10,27,31,34**
- warnings issued for, **5-11; 9-44,68**

AVG1000 (Average 1000 Times)

- algorithm for, **9-73**
- demonstration of, **5-11**
- discussion of, **xxii; 1-13; 5-4,10; 6-20; 9-44**
- location of, **Fig. B block 6**
- restrictions for, **5-11; 9-44,61**
- usage of, **5-11**
- warnings issued for, **5-11; 9-44,68**

B

BOTH (Both Display)

- demonstration of, **5-7,34**
- discussion of, **xxii,xxxii; 1-1,13; 5-3,7,14,15,16,34,35; 6-1; 7-17,18; 9-4,5,15**
- location of, **Fig. B block 7; Fig. D block 14**
- usage of, **5-7,34; 6-23,28,39,52**

C

CEROFF (Disable Command Error SRQ)

- discussion of, **1-14; 7-8,21; 9-58**

CERON (Enable Command Error SRQ)

- discussion of, **1-14; 7-8; 9-58**

CHS (Change Sign)

- demonstration of, **6-6**
- discussion of, **xxix; 1-14; 6-3,6,11,94; 9-25**
- location of, **Fig. D block 8**
- restrictions for, **9-25,61**
- usage of, **6-6,15,40,57,58,64,77,78,79,80,86,87,88,93**

CLD (Clear Display)

- demonstration of, **6-50**
- discussion of, **xxxii; 1-14; 6-19,50; 9-37**
- location of, **Fig. D block 12**
- usage of, **6-50**

CL \bar{f} (Clear Shift Flag)

- discussion of, **xxx; 1-14; 6-6; 9-26,35**
- location of, **Fig. D block 11**

CLL (Clear Program Line)

demonstration of, **6-123**
 discussion of, **xxvi; 1-14; 6-95,97,114,121,123; 9-27**
 location of, **Fig. D block 1**
 restrictions for, **6-123; 9-27,61**
 usage of, **6-123,133**

CLP (Clear Program Memory)

demonstration of, **6-105**
 discussion of, **xxvi; 1-14; 6-95,97,105,121; 9-27**
 location of, **Fig. D block 1**
 restrictions for, **6-105; 9-27,61**
 usage of, **6-105,125; 7-11**
 warnings issued for, **6-105**

CLS (Clear Stack)

demonstration of, **6-13**
 discussion of, **xxvii; 1-14; 6-12,13; 9-36**
 location of, **Fig. D block 4**
 usage of, **6-13**

CLW (Clear Waveform)

demonstration of, **6-50**
 discussion of, **xxxi; 1-14; 6-50; 9-37**
 location of, **Fig. D block 12**
 restrictions for, **6-50; 9-37,61**
 usage of, **6-50**
 warnings issued for, **6-50; 9-37,69**

CLX (Clear X Register)

demonstration of, **6-6**
 discussion of, **xxviii; 1-14; 6-6,12; 9-36**
 location of, **Fig. D block 4**
 usage of, **6-6,8,40,93**

CNS (Return Constant)

demonstration of, **6-17**
 discussion of, **xxx; 1-14; 6-17,18; 9-19**
 location of, **Fig. D block 10**
 restrictions for, **6-17; 9-19,61**
 usage of, **6-17,98,101,102,103,113,115,123,124,129,130,131**

CNS (Store Constant)

demonstration of, **6-17**
 discussion of, **xxx; 1-14; 6-17; 9-20**
 location of, **Fig. D block 10**
 restrictions for, **6-17; 9-20,61**
 usage of, **6-17,98,101,102,112,113,115,116,121,123,125,129,131,133**

CRS1 (Cursor 1 On)

demonstration of, **5-18**
 discussion of, **xxi,xxix; 1-14; 5-18; 6-61; 9-16**
 location of, **Fig. B block 3; Fig. D block 9**
 usage of, **5-18; 6-57,59,61,90,93,112,115,129**

Appendix A—Command Index

CRS1< (Cursor 1 Left)

- demonstration of, **5-19,21**
- discussion of, **xxi,xxix; 1-14; 5-19; 9-17**
- location of, **Fig. B block 3; Fig. D block 7**
- restrictions for, **9-17,61**
- usage of, **5-19,21; 6-71,82**
- warnings issued for, **5-19; 9-17,69**

CRS1> (Cursor 1 Right)

- demonstration of, **5-8,21**
- discussion of, **xxi,xxix; 1-14; 5-19; 9-17**
- location of, **Fig. B block 3; Fig. D block 7**
- restrictions for, **9-17,61**
- usage of, **5-18,21,25,26,28,32; 6-56,90**
- warnings issued for, **5-18; 9-17,69**

CRS2-1 (Both Cursors On)

- demonstration of, **5-19; 6-55**
- discussion of, **xxi,xxix; 1-14; 5-19; 6-55; 9-17**
- location of, **Fig. B block 3; Fig. D block 9**
- usage of, **5-19,25,28; 6-55,58,59,61,71,81,92,113,115,130**

CRS2< (Cursor 2 Left)

- demonstration of, **5-20,21**
- discussion of, **xxi,xxix; 1-14; 5-19,20; 9-17**
- location of, **Fig. B block 3; Fig. D block 7**
- restrictions for, **9-17,61**
- usage of, **5-20,21,25; 6-56,71,82,92**
- warnings issued for, **5-20,28; 9-17,69**

CRS2> (Cursor 2 Right)

- demonstration of, **5-20**
- discussion of, **xxi,xxix; 1-14; 5-19; 9-17**
- location of, **Fig. B block 3, Fig. D block 7**
- restrictions for, **9-17,61**
- usage of, **5-20,32**
- warnings issued for, **5-20; 9-17,69**

D

DELAY (Return Delay Time)

- accuracy of, **2-12**
- demonstration of, **5-30**
- discussion of, **xx,xxviii; 1-14; 5-22,29,30; 9-54**
- location of, **Fig. B block 2; Fig. D block 6**
- restrictions for, **5-30; 9-54,61**
- usage of, **5-30; 6-113,116,129,133**

DIFF (Differentiate)

- accuracy of, **2-11**
- algorithm for, **9-74**
- demonstration of, **6-84**
- discussion of, **xxxii; 1-14; 6-83,84; 9-46**
- location of, **Fig. D block 18**
- restrictions for, **6-84; 9-46,61**
- usage of, **6-84**

DOTS (Dots Display)
 demonstration of, **6-46**
 discussion of, **xxx**; **1-14**; **6-45,46**; **9-37**
 location of, **Fig. D block 12**
 usage of, **6-46**

DSW (Display Stored Waveform)
 demonstration of, **6-48**
 discussion of, **xxxi**; **1-14**; **6-45,48**; **9-37**
 location of, **Fig. D block 12**
 restrictions for, **6-49**; **9-38,62**
 usage of, **6-48,49,54**
 warnings issued for, **6-48**; **9-38,69**

E

EEX (Enter Exponent)
 demonstration of, **6-11**
 discussion of, **xxix**; **1-14**; **6-3,11,94**; **9-24,25,26**
 location of, **Fig. D block 8**
 usage of, **6-11,40,57,58,64,77,78,79,80,86,87,88**
 warnings issued for, **9-24,69**

ENERGY (Return Energy)
 accuracy of, **2-12**
 algorithm for, **9-74**
 demonstration of, **5-26**
 discussion of, **xx,xxviii**; **1-15**; **5-22**; **9-52**
 location of, **Fig. B block 1**; **Fig. D block 5**
 usage of, **5-26**

ENTER (Enter Data)
 demonstration of, **6-7,14**
 discussion of, **xxvii**; **1-15**; **6-3,7,12,13**; **9-36**
 location of, **Fig. D block 4**
 usage of, **6-7,9,10,11,12,14,17,33,34,75,81,88,89,121,125,131**

ERR? (Transmit Error Status)
 discussion of, **7-9**; **9-58**

EXECUTE (Program Execute Mode)
 demonstration of, **6-104**
 discussion of, **xxxiii**; **1-15**; **6-95,96,97,104**; **9-27**
 location of, **Fig. D block 19**
 usage of, **6-104,117,124,130,132,134**; **7-10,19**

EXP (Exponentiation)
 accuracy of, **2-11,13**
 demonstration of, **6-15,39**
 discussion of, **xxvi**; **1-15**; **6-12,15,37,39**; **9-11**
 location of, **Fig. D block 2**
 usage of, **6-15,16,39**

Appendix A—Command Index

EXROFF (Disable Execution Error SRQ)
discussion of, 1-15; 7-8,21; 9-58

EXRON (Enable Execution Error SRQ)
discussion of, 1-15; 7-8; 9-58

F

f (Set Shift Flag)

demonstration of, 5-7
discussion of, *xxi,xxx*; 1-15; 5-7; 6-6; 9-26,35
location of, Fig. B block 4; Fig. D block 11
usage of, 5-7; preceding all shift commands

r (Return Fall Time)

accuracy of, 2-12
demonstration of, 5-30
discussion of, *xx,xxviii*; 1-15; 5-22,29,30; 9-54
location of, Fig. B block 2; Fig. D block 6
restrictions for, 5-30; 9-54,62
usage of, 5-30; 6-113,115,129,133

r (Return Frequency)

accuracy of, 2-12
algorithm for, 9-75
demonstration of, 5-33
discussion of, *xx,xxviii*; 1-15; 5-22,33; 9-54
location of, Fig. B block 1; Fig. D block 5
restrictions for, 5-33; 9-54,62
usage of, 5-33

G

GND (Set Ground Reference)

demonstration of, 5-8; 6-23
discussion of, 1-15; 5-4,8,9; 6-23,24; 9-45
location of, Fig. B block 6; Fig. D block 15
restrictions for, 5-9; 6-24; 9-45,62
usage of, 5-8,9,22; 6-23,37
warnings issued for, 6-23; 9-45,69

GOTO (Go To Program Line)

demonstration of, 6-118
discussion of, 1-15; 6-110,111,119; 9-28
location of, Fig. D block 19
restrictions for, 6-119; 9-28,62
usage of, 6-103,118,120,123,129; 7-10
warnings issued for, 6-118; 9-28,69

GSB (Go To Subroutine)

demonstration of, 6-125
discussion of, *xxxiii*; 1-15; 6-111,121,125; 9-28,29
location of, Fig. D block 19
restrictions for, 6-125; 9-29,62
usage of, 6-125,131
warnings issued for, 9-29,69

H

- HCRD** (Return Horizontal Coordinate)
 accuracy of, **2-11**
 demonstration of, **6-62**
 discussion of, **xxix; 1-15; 6-62; 9-16,19**
 location of, **Fig. D block 9**
 restrictions for, **6-62; 9-19,62**
 usage of, **6-62,86,90,93,113,115,129**
- >**HCRD** (Set Horizontal Coordinate)
 demonstration of, **6-57,58**
 discussion of, **xxix; 1-15; 6-57,58,59; 9-16,17,18**
 location of, **Fig. D block 9**
 restrictions for, **6-59; 9-18,63**
 usage of, **6-57,58,61,113,115,130**
 warnings issued for, **6-58,59; 9-18,69**
- HMDA** (Horizontal Mode A)
 demonstration of, **4-14**
 discussion of, **1-15; 4-8**
 location of, **Fig. A block 6**
- HMDALT** (Horizontal Mode ALT)
 demonstration of, **4-14**
 discussion of, **1-15; 4-8**
 location of, **Fig. A block 6**
- HMDB** (Horizontal Mode B)
 demonstration of, **4-14; 6-100**
 discussion of, **1-15; 4-8; 6-100**
 location of, **Fig. A block 6**
 usage of, **6-100,112,115,125**
- HMDCHOP** (Horizontal Mode CHOP)
 demonstration of, **4-14**
 discussion of, **1-15; 4-9**
 location of, **Fig. A block 6**
- HPLFT** (Horizontal Position Left)
 demonstration of, **6-75,76,77**
 discussion of, **xxxii; 1-15; 6-75,76,77,80,81,82; 9-47**
 location of, **Fig. D block 18**
 restrictions for, **6-77,78,80; 9-47,63**
 usage of, **6-76,77,80,81,82,93**
- HPRGT** (Horizontal Position Right)
 demonstration of, **6-78,79,80,82**
 discussion of, **xxxiii; 1-15; 6-78,79,80,83; 9-47**
 location of, **Fig. D block 18**
 restrictions for, **6-78; 9-48,63**
 usage of, **6-76,78,79,81**

Appendix A—Command Index

HSCL (Return Horizontal Scale Factor)

accuracy of, **2-13**
demonstration of, **6-66**
discussion of, **xxxii; 1-15; 6-66; 9-56**
location of, **Fig. D block 17**
usage of, **6-66,93**

HSCL (Set Horizontal Scale Factor)

accuracy of, **2-13**
demonstration of, **6-64**
discussion of, **xxxii; 1-15; 6-64; 9-56**
location of, **Fig. D block 17**
restrictions for, **6-65; 9-56,63**
usage of, **6-63,64,65**

HXP (Horizontally Expand Waveform)

algorithm for, **9-75**
demonstration of, **6-69,70,71**
discussion of, **xxxiii; 1-16; 6-68,69,70,71,72; 9-48**
location of, **Fig. D block 18**
restrictions for, **6-69,72; 9-48,49,63**
usage of, **6-69,70,71,93**
warnings issued for, **6-69,70; 9-48,49,69,70**

I

ID (Identify Instrument)

discussion of, **xxi; 1-16; 7-17; 9-22**
location of, **Fig. B block 5**

ID? (Transmit Instrument Identity)

discussion of, **7-8; 9-58**

INTG (Integrate)

accuracy of, **2-11**
algorithm for, **9-75**
demonstration of, **6-84**
discussion of, **xxxii; 1-16; 6-83,84; 9-50**
location of, **Fig. D block 18**
restrictions for, **6-84; 9-50**
usage of, **6-84,93**

ITRP (Interpolate)

accuracy of, **2-11**
demonstration of, **6-89,90,91,92**
discussion of, **xxxii; 1-16; 6-83,89,90,91,92,93; 9-49**
location of, **Fig. D block 18**
restrictions for, **6-89,91,92; 9-49,50,63,64**
usage of, **6-89,91,92,93**

IFX=Y (If X Register Equals Y Register)

demonstration of, **6-123**
discussion of, **xxxiii; 1-16; 6-111,121,124; 9-29,30**
location of, **Fig. D block 19**
usage of, **6-123,129**

IFY>X (If Y Register Greater Than X Register)
 demonstration of, **6-131**
 discussion of, **xxxiii; 1-16; 6-111,121,132; 9-30**
 location of, **Fig. D block 19**
 usage of, **6-98,102,103,131**

IOCOFF (Disable Input/Output SRQ)
 discussion of, **1-16; 7-8,21; 9-58**

IOCON (Enable Input/Output SRQ)
 discussion of, **1-16; 7-8; 9-58**

L

(Return Labeled Line)
 demonstration of, **6-118**
 discussion of, **xxxiii; 1-16; 6-110,111,118; 9-31**
 location of, **Fig. D block 19**
 restrictions for, **6-119; 9-31,64**
 usage of, **6-103,118,120,123,125,129,131**

LN (Natural Logarithm)
 accuracy of, **2-11,13**
 demonstration of, **6-15,39**
 discussion of, **xxvi; 1-16; 6-12,15,16,37,39; 9-11,12**
 location of, **Fig. D block 2**
 usage of, **6-15,16,39,40**
 warnings issued for, **6-15,39; 9-12,70**

^A (Begin Label)
 demonstration of, **6-99,114**
 discussion of, **xxvi; 1-16; 6-99,114; 9-31**
 location of, **Fig. D block 1**
 restrictions for, **6-114; 9-31,64**
 usage of, **6-99,102,112,114,123,125,129,131**

M

MAX (Return Maximum Value)
 accuracy of, **2-12**
 demonstration of, **5-23**
 discussion of, **xx,xxviii; 1-16; 5-22,23; 9-52**
 location of, **Fig. B block 1; Fig. D block 5**
 usage of, **5-23; 6-61,112,115,129; 7-12**

MEAN (Return Mean Value)
 accuracy of, **2-12**
 algorithm for, **9-75**
 demonstration of, **5-25**
 discussion of, **xx,xxviii; 1-16; 5-22,25; 9-52**
 location of, **Fig. B block 1; Fig. D block 5**
 usage of, **5-25**

Appendix A—Command Index

MID (Return Middle Value)

- accuracy of, **2-12**
- demonstration of, **5-24**
- discussion of, **xx,xxviii; 1-16; 5-22,24; 9-52**
- location of, **Fig. B block 1; Fig. D block 5**
- usage of, **5-24,32; 6-43,93**

MIN (Return Minimum Value)

- accuracy of, **2-12**
- demonstration of, **5-24**
- discussion of, **xx,xxviii; 1-16; 5-22,24; 9-52**
- location of, **Fig. B block 1, Fig. D block 5**
- usage of, **5-24**

N

NEXT (Go To Next Line)

- demonstration of, **6-105,114**
- discussion of, **xxvi; 1-16; 6-97,99,105,114,115,121; 7-10; 9-31**
- location of, **Fig. D block 1**
- restrictions for, **6-115; 9-32,64**
- usage of, **6-99 and throughout Programming.**
- warnings issued for, **6-101,114,115; 9-32,70**

O

OFF (Cursors Off)

- demonstration of, **5-20**
- discussion of, **xxi,xxix; 1-16; 5-20; 9-16**
- location of, **Fig. B block 3; Fig. D block 9**
- usage of, **5-20,21; 6-93,100,112,115,123,129**

OPCOFF (Disable Operation Complete SRQ)

- discussion of, **1-16; 7-8,21; 9-58**

OPCON (Enable Operation Complete SRQ)

- discussion of, **1-16; 7-8; 9-58**

ORD (Return Ordinate Value)

- accuracy of, **2-11**
- demonstration of, **6-86**
- discussion of, **xxxii; 1-16; 6-83,86; 9-50**
- location of, **Fig. D block 18**
- restrictions for, **9-51,64**
- usage of, **6-86**

·ORD (Set Ordinate Value)

- accuracy of, **2-12**
- demonstration of, **6-87**
- discussion of, **xxxii; 1-16; 6-83,88; 9-51**
- location of, **Fig. D block 18**
- restrictions for, **6-88; 9-51,64**
- usage of, **6-86,87,93**

P

PAUSE (Pause)

- demonstration of, **6-133**
- discussion of, **xxxiv; 1-17; 5-4; 6-3,132,133,134; 9-25,32**
- location of, **Fig. D block 19**
- usage of, **6-133,134**

PER (Return Period)

- accuracy of, **2-12**
- algorithm for, **9-76**
- demonstration of, **5-32**
- discussion of, **xx,xxviii; 1-17; 5-22,29,32; 9-54**
- location of, **Fig. B block 1; Fig. D block 5**
- restrictions for, **5-33; 9-55,65**
- usage of, **5-32**

PNT (Return Point Value)

- accuracy of, **2-11**
- demonstration of, **6-33**
- discussion of, **xxx; 1-17; 6-33; 9-20**
- location of, **Fig. D block 10**
- restrictions for, **6-33; 9-20,65**
- usage of, **6-33,41,43**

>PNT (Set Point Value)

- accuracy of, **2-11**
- demonstration of, **6-34**
- discussion of, **xxx; 1-17; 6-34; 9-20**
- location of, **Fig. D block 10**
- restrictions for, **6-34; 9-20,65**
- usage of, **6-34,76,81**

P-P (Return Peak-to-Peak Value)

- accuracy of, **2-12**
- demonstration of, **5-24**
- discussion of, **xx,xxviii; 1-17; 5-22,24; 9-53**
- location of, **Fig. B block 1; Fig. D block 5**
- usage of, **5-24; 6-43,98,101,102,131**

PREV (Go To Previous Line)

- demonstration of, **6-121**
- discussion of, **xxvi; 1-17; 6-97,121; 9-32**
- location of, **Fig. D block 1**
- restrictions for, **6-121; 9-32,65**
- usage of, **6-121,133**

PROG (Program Entry Mode)

- demonstration of, **6-99**
- discussion of, **xxvi; 1-17; 6-96,97,104; 9-32**
- location of, **Fig. D block 1**
- usage of, **6-99,104,114,121,124,131; 7-10,11**

Appendix A—Command Index

P/W (Return Points-per-Waveform)
demonstration of, **6-21**
discussion of, **xxx; 1-17; 6-18,19,20,21; 9-20**
location of, **Fig. D block 10**
usage of, **6-21,65**

P W (Set Points-per-Waveform)
demonstration of, **6-31,32**
discussion of, **xxx; 1-17; 6-18,19,20,31; 9-21**
location of, **Fig. D block 10**
restrictions for, **6-31; 9-21,65**
usage of, **6-31,32,46,51**

R

READX (Input X Register Value)
discussion of, **xxvii; 1-17; 7-4,8,9,11,14,21; 9-23**
location of, **Fig. D block 3**
restrictions for, **9-23,65**
usage of, **7-12,15,16**

REMOFF (Disable Effect of RQS)
discussion of, **1-17; 7-8,21; 9-58**

REMON (Enable Effect of RQS)
discussion of, **1-17; 7-8; 9-58**

RDOUT (Return Readout Setting)
demonstration of, **6-35**
discussion of, **xxxi; 1-17; 5-4; 6-35; 9-45**
location of, **Fig. D block 15**
restrictions for, **6-35; 9-46,65**
usage of, **6-35**
warnings issued for, **6-35; 9-46,70**

RISE (Return Rise Time)
accuracy of, **2-12**
demonstration of, **5-29**
discussion of, **xx,xxviii; 1-17; 5-22,29; 9-55**
location of, **Fig. B block 2; Fig. D block 6**
restrictions for, **5-29; 9-55,66**
usage of, **5-29; 6-113,115,129,133**

RMS (Return Root-Mean-Square)
accuracy of, **2-12**
algorithm for, **9-76**
demonstration of, **5-25**
discussion of, **xx,xxviii; 1-17; 5-22,25; 9-53**
location of, **Fig. B block 1; Fig. D block 5**
usage of, **5-25**

- ROLL** (Roll Stack)
 demonstration of, **6-12**
 discussion of, **xxvii; 1-17; 6-12; 9-36**
 location of, **Fig. D block 4**
 usage of, **6-12,13**
- RQS** (Assert SRQ)
 discussion of, **xxi; 1-17; 7-8,21; 9-23**
 location of, **Fig. B block 5**
- RQSOFF** (Disable All SRQ's)
 discussion of, **1-17; 7-8,21; 9-58**
- RQSON** (Enable All SRQ's)
 discussion of, **1-17; 7-8,21; 9-58**
- RTN** (Return from Subroutine)
 demonstration of, **6-130**
 discussion of, **xxxiii; 1-17; 6-111,121,130; 9-32**
 location of, **Fig. D block 19**
 restrictions for, **6-130; 9-32,66**
 usage of, **6-130,131**
- RUN** (Run Program)
 demonstration of, **6-119**
 discussion of, **xxxiii; 1-17; 6-3,97,119,120,133; 9-25,33**
 location of, **Fig. D block 19**
 restrictions for, **6-119; 9-33,66**
 usage of, **6-119**

S

- SAVE** (Save Program)
 discussion of, **xxvii; 1-17; 7-4,8,9,10,21; 9-23**
 location of, **Fig. D block 3**
 restrictions for, **9-23,66**
 usage of, **7-10**
- SCOPE** (Scope Display)
 discussion of, **xxii,xxxi; 1-1,17; 4-1 to 4-18; 7-17,18; 9-3,15**
 location of, **Fig. B block 7; Fig. D block 14**
 usage of, **3-3; 4-13; 5-10; 6-24,47,100,112,115,117,125**
- SEND λ** (Output X Register Value)
 discussion of, **xxvii; 1-18; 7-4,8,9,11,14,21; 9-23**
 location of, **Fig. D block 3**
 restrictions for, **9-23,66**
 usage of, **7-12,14,15**

Appendix A—Command Index

SGN (Return Signum)

- accuracy of, **2-11**
- demonstration of, **6-15,40**
- discussion of, **xxvii; 1-18; 6-12,15,37,40; 9-12**
- location of, **Fig. D block 2**
- usage of, **6-15,40**

SMOOTH (Smooth Waveform)

- accuracy of, **2-11**
- algorithm for, **9-76**
- demonstration of, **6-85**
- discussion of, **xxxii; 1-18; 6-83,85; 9-51**
- location of, **Fig. D block 18**
- restrictions for, **6-85; 9-51,66**
- usage of, **6-85,93**

SQRT (Return Square Root)

- accuracy of, **2-11,13**
- demonstration of, **6-15,38**
- discussion of, **xxvi; 1-18; 6-12,15,37,38; 9-12**
- location of, **Fig. D block 2**
- usage of, **6-15,38**
- warnings issued for, **6-15,38; 9-12,70**

SRQ? (Transmit Line 16)

- discussion of, **7-9; 9-59**
- usage of, **7-20**

START (Start Program)

- demonstration of, **6-104,117**
- discussion of, **xxiv; 1-18; 6-97,104,118; 9-33**
- location of, **Fig. D block 19**
- restrictions for, **6-118; 9-33,66**
- usage of, **6-104,117,124,130,132,134**

STEP (Execute Program By Lines)

- demonstration of, **6-120**
- discussion of, **xxxiii; 1-18; 6-3,97,120; 9-25,34**
- location of, **Fig. D block 9**
- usage of, **6-120**
- warnings issued for, **6-120; 9-34,70**

STOP (Stop)

- demonstration of, **5-10; 6-132**
- discussion of, **xxii,xxxiv; 1-18; 5-3,4; 6-3,97,111,120,132,133,134,135; 7-4; 9-25,34**
- location of, **Fig. B block 6; Fig. D block 19**
- usage of, **5-10; 6-102,103,113,116,123,129,131**
- warnings issued for, **9-70**

STORED (Stored Display)

- demonstration of, **5-6**
- discussion of, **xxii,xxxi; 1-1,18; 5-3,6,14,15,16; 6-1,104; 7-17,18; 9-4,5,15**
- location of, **Fig. B block 7; Fig. D block 14**
- usage of, **4-13; 5-6,9,10,12,18,23,28; 6-1,21,25, 29,38,41,46,48,52,53,63,72,83, 104,112,115,125**

SWH (Set TTL SIGNAL OUT High)
 accuracy of, **2-7**
 discussion of, **xxvii; 1-18; 2-7; 9-23**
 location of, **Fig. D block 3**

SWL (Set TTL SIGNAL OUT Low)
 accuracy of, **2-7**
 discussion of, **xxvii; 1-18; 2-7; 9-23**
 location of, **Fig. D block 3**

T

TEXT (Transmit Text)
 discussion of, **1-18; 7-4,8,9,18,21; 9-59**
 restrictions for, **9-59,66**
 usage of, **7-20**

>TEXT (Input Text)
 discussion of, **1-18; 7-4,8,9,17,18,21; 9-59**
 restrictions for, **9-59,66**
 usage of, **7-19**
 warnings issued for, **9-59,70**

TIME (Versus Time)
 demonstration of, **6-54**
 discussion of, **xxx; 1-18; 6-19,45,54; 9-38**
 location of, **Fig. D block 12**
 usage of, **6-54,56**

V

VCRD (Return Vertical Coordinate)
 accuracy of, **2-11**
 demonstration of, **6-62**
 discussion of, **xxix; 1-18; 6-62; 9-16,19**
 location of, **Fig. D block 9**
 restrictions for, **6-62; 9-19,66**
 usage of, **6-62**

>VCRD (Set Vertical Coordinate)
 accuracy of, **2-11**
 demonstration of, **6-59,60,61**
 discussion of, **xxix; 1-18; 2-11; 6-59,61; 9-16,18**
 location of, **Fig. D block 9**
 restrictions for, **6-61; 9-18,66**
 usage of, **6-59,60,61,113,115,129**

VECT (Vector Display)
 demonstration of, **6-47**
 discussion of, **xxx; 1-18; 6-45,47; 9-38**
 location of, **Fig. D block 12**
 usage of, **6-47**

VMDADD (Vertical Mode ADD)
 demonstration of, **4-13**
 discussion of, **1-18; 4-7**
 location of, **Fig. A block 4**

Appendix A—Command Index

VMDALT (Vertical Mode ALT)
demonstration of, **4-13**
discussion of, **1-18; 4-5**
location of, **Fig. A block 4**

VMDCHOP (Vertical Mode CHOP)]
demonstration of, **4-13**
discussion of, **1-18; 4-7**
location of, **Fig. A block 4**

VMDL (Vertical Mode LEFT)
demonstration of, **4-13; 6-100**
discussion of, **1-18; 4-5; 6-100**
location of, **Fig. A block 4**
usage of, **6-100,112,115,125**

VMDR (Vertical Mode RIGHT)
demonstration of, **4-13**
discussion of, **1-18; 4-5**
location of, **Fig. A block 4**

VPDN (Vertical Position Down)
discussion of, **xxxi; 1-19; 6-72,74; 9-40**
location of, **Fig. D block 13**
restrictions for, **6-74; 9-40,67**
warnings issued for, **9-40,70**

VPUP (Vertical Position Up)
demonstration of, **6-73**
discussion of, **xxxi; 1-19; 6-72,73; 9-40**
location of, **Fig. D block 13**
restrictions for, **9-40,67**
usage of, **6-73**
warnings issued for, **6-73; 9-40,70**

(X Versus Y Mode)
demonstration of, **6-53**
discussion of, **xxx; 1-19; 6-45,53,54,59,65; 9-7,38**
location of, **Fig. D block 12**
restrictions for, **6-54; 9-38,67**
usage of, **6-51,53**

VSCL (Return Vertical Scale Factor)
accuracy of, **2-12**
demonstration of, **6-66**
discussion of, **xxxii; 1-19; 6-66; 9-56**
location of, **Fig. D block 17**
usage of, **6-40,66**

(Set Vertical Scale Factor)
accuracy of, **2-12**
demonstration of, **6-64**
discussion of, **xxxii; 1-19; 6-64; 9-56**
location of, **Fig. D block 17**

·VSCL (Cont)
 restrictions for, **6-64; 9-56,67**
 usage of, **6-40,63,64**

VXPD (Vertically Expand Waveform)
 accuracy of, **2-13**
 demonstration of, **6-67**
 discussion of, **xxxii; 1-19; 6-67; 9-56**
 location of, **Fig. D block 17**
 restrictions for, **6-67; 9-57,67**
 usage of, **6-67**
 warnings issued for, **6-67; 9-57,71**

VZR (Return Vertical Zero Reference)
 accuracy of, **2-12**
 discussion of, **xxxii; 1-19; 9-57**
 location of, **Fig. D block 17**

VZR (Set Vertical Zero Reference)
 accuracy of, **2-13**
 demonstration of, **6-74,75**
 discussion of, **xxxii; 1-19; 6-74; 9-57**
 location of, **Fig. D block 17**
 restrictions for, **6-74; 9-57,67**
 usage of, **6-74,75**
 warnings issued for, **6-74; 9-57,71**

W

WFM (Return Stored Waveform)
 demonstration of, **6-22**
 discussion of, **xxx; 1-19; 6-22; 9-21**
 location of, **Fig. D block 10**
 restrictions for, **6-22; 9-21,67**
 usage of, **6-22,25,26,29,30,38,39,40,41,42,43,68,91,93,131;7-14,15**

WFM (Copy Stored Waveform)
 demonstration of, **6-26**
 discussion of, **xxx; 1-19; 6-20,26; 9-21**
 location of, **Fig. D block 10**
 restrictions for, **6-26; 9-21,68**
 usage of, **6-26,27,38,39,47,48,52,53,68,98,101,112,115,125**

WIDTH (Return Width)
 accuracy of, **2-12**
 demonstration of, **5-31**
 discussion of, **xx,xxviii; 1-19; 5-22,29,31; 9-55**
 location of, **Fig. B block 2; Fig. D block 6**
 restrictions for, **5-31; 9-55,68**
 usage of, **5-31; 6-113,116,129,133**

Appendix A—Command Index

X<>Y (X Exchange Y)

- demonstration of, **6-13**
- discussion of, **xxvii; 1-19; 6-12,13; 9-36**
- location of, **Fig. D block 4**
- usage of, **6-13,40**

0,1,2,3,4,5,6,7,8,9 (Digits)

- demonstration of, **6-5**
- discussion of, **xxix; 1-19; 6-3,94; 9-24**
- location of, **Fig. D block 8**
- usage of, **Throughout Section 6**
- warnings issued for, **6-5; 9-71**

. (Decimal Point)

- demonstration of, **6-5**
- discussion of, **xxix; 1-19; 6-3; 9-24**
- location of, **Fig. D block 8**
- usage of, **6-5 and throughout Section 6**
- warnings issued for, **6-5; 9-24,71**

+ (Add)

- accuracy of, **2-11,13**
- demonstration of, **6-7**
- discussion of, **xxvii; 1-19; 6-7,8,36; 9-13**
- location of, **Fig. D block 2**
- usage of, **6-7,9,10,11,40,44,93,123,129**
- warnings issued for, **9-71**

- (Subtract)

- accuracy of, **2-11,13**
- demonstration of, **6-7**
- discussion of, **xxvii; 1-19; 6-7,8,36; 9-13**
- location of, **Fig. D block 2**
- usage of, **6-7,10,11,43,93**
- warnings issued for, **9-71**

* (Multiply)

- accuracy of, **2-11,13**
- demonstration of, **6-7,41**
- discussion of, **xxvii; 1-19; 6-7,8,36,41; 9-13**
- location of, **Fig. D block 2**
- usage of, **6-7,10,11,14,16,40,41,44,93,98,101,102**
- warnings issued for, **9-71**

/ (Divide)

- accuracy of, **2-11,13**
- demonstration of, **6-7,42**
- discussion of, **xxvii; 1-19; 6-7,8,36,42; 9-13**
- location of, **Fig. D block 2**
- usage of, **6-7,9,10,16,40,42,43,65**
- warnings issued for, **6-8,42; 9-13,71**

Page vi

FOR SN B099999 AND BELOW

SECTION 8—INSTRUMENT OPTIONS

OPTION 02.....	8-1
OPTION 03.....	8-1
OPTION 78.....	8-1
OPTION 00.....	8-1
OPTION 20.....	8-1
OPTION A1.....	8-1
OPTION A2.....	8-1
OPTION A3.....	8-1
OPTION A4.....	8-1
OPTION 1S.....	8-2
OPTION 2S.....	8-2
INSTRUMENT OPTION IDENTIFICATION.....	8-2

FOR SN B100000 AND ABOVE

SECTION 8—INSTRUMENT OPTIONS

OPTION 02.....	8-1
OPTION 03.....	8-1
OPTION 78.....	8-1
OPTION A1.....	8-1
OPTION A2.....	8-1
OPTION A3.....	8-1
OPTION A4.....	8-1
OPTION 1S.....	8-2
OPTION 2S.....	8-2
INSTRUMENT OPTION IDENTIFICATION.....	8-2

DESCRIPTION

Page xxiii

FOR SN B099999 AND BELOW

Foldout for Rear Panel Controls, Connectors & Indicators (Figure c)

- 11 MEMORY BACK-UP POWER Connectors—Two female banana jacks for applying 5.5 to 6.5 V DC to provide non-volatile memory.

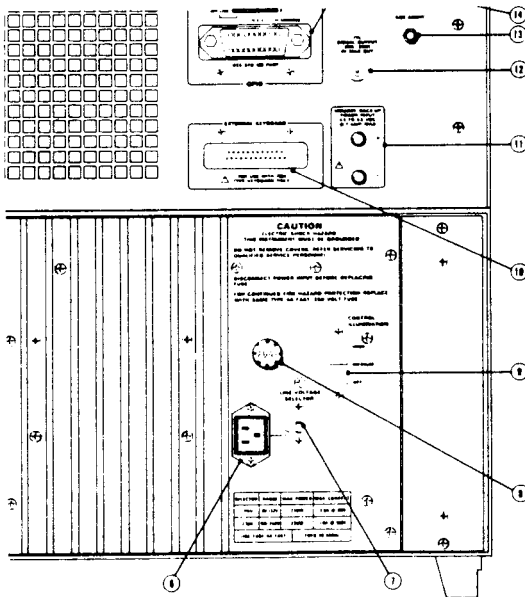

Figure C. Locator for 7854 rear-panel controls, connectors, and indicators.

DESCRIPTION

Page xxiii

FOR SN B100000 AND ABOVE

Foldout for Rear Panel Controls, Connectors & Indicators (Figure c)

- 11 MEMORY BACK-UP POWER—3.5 V Lithium Battery located on memory board used for applying 2-3.5 V DC to provide non-volatile memory.

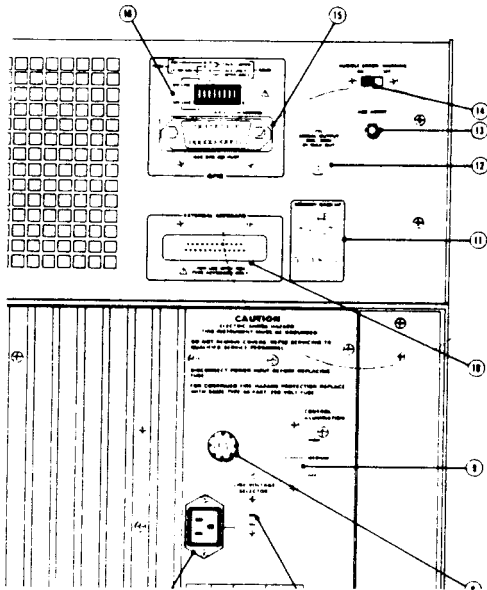

Figure C. Locator for 7854 rear-panel controls, connectors, and indicators.

DESCRIPTION

Page 1-5

FOR SN B099999 AND BELOW

MEMORY BACK-UP POWER !

Two female banana jacks (on the rear panel of the 7854 Oscilloscope mainframe) allow application of about 6.25 V dc (0.7 A maximum) to provide back-up power for the volatile storage devices used for processor memory. The instrument is fuse protected for application of any voltages applied to the MEMORY BACK-UP POWER INPUT up to ± 50 volts (dc plus peak ac). When power is first applied to the MEMORY BACK-UP POWER INPUT the red indicator lights to indicate that the fuse has not blown.

CAUTION

To prevent loss of data from memory due to a power failure, apply memory back-up power.

FOR SN B100000 AND ABOVE

MEMORY BACK-UP !

When in MEMORY BACK-UP POSITION this provides MEMORY BACK-UP in the Self Test on Turn On position. At Turn On it will reset RAM and do its self-test.

Page 1-6

FOR SN B099999 AND BELOW

GENERAL PURPOSE INTERFACE BUS (GPIB)

The 7854 (except Option 0D) is equipped with an IEEE 488-1978 Digital Interface for Programmable Instrumentation, commonly referred to as a General Purpose Interface Bus, or GPIB. The GPIB allows remote control of all processor functions, and data transfers to and from the 7854.

The GPIB connector and associated address and function selector switches are mounted on the rear panel of the 7854. Refer to the GPIB section of this manual for complete GPIB information.

DESCRIPTION

FOR SN B100000 AND ABOVE**GENERAL PURPOSE INTERFACE BUS (GPIB)**

The 7854 is equipped with an IEEE 488-1978 Digital Interface for Programmable Instrumentation, commonly referred to as a General Purpose Interface Bus, or GPIB. The GPIB allows remote control of all processor functions, and data transfers to and from the 7854.

The GPIB connector and associated address and function selector switches are mounted on the rear panel of the 7854. Refer to the GPIB section of this manual for complete GPIB information.

Page 1-7

FOR SN B099999 AND BELOW**POWER-UP CONDITIONS**

When the 7854 is turned on (without memory back-up power applied), the waveform processor runs four self-checking tests. Although these tests are not all-inclusive, they indicate if major portions of the processor are properly working. The self-test sequence outlined below begins when power is applied to the 7854.

- Step 1:** When power is applied the following indicators will light: POWER, selected positions of the A and B TRIGGER SOURCE switches, and all selected indicators on the plug-in units. For approximately three seconds after power-up the following indicators will remain off: all positions of the VERTICAL and HORIZONTAL MODE switches, all Intensity indicators, all red front-panel (measurement keyboard) and Waveform Calculator indicators.
- Step 2:** All positions of the VERTICAL and HORIZONTAL MODE switches, all Intensity indicators, and all red front-panel and Waveform Calculator indicators will now light.
- Step 3:** A fault condition found through any of the four tests is indicated with the lights of the VERTICAL and HORIZONTAL MODE switches. Fault condition codes are listed in Table 1-3. Be sure to note the code received so that you may more fully inform the service person about the trouble.

DESCRIPTION

FOR SN B100000 AND ABOVE

POWER-UP CONDITIONS

When the 7854 is turned on (without memory back-up on), the waveform processor runs four self-checking tests. Although these tests are not all-inclusive, they indicate if major portions of the processor are properly working. The self-test sequence outlined below begins when power is applied to the 7854.

- Step 1:** When power is applied the following indicators will light: POWER, selected positions of the A and B TRIGGER SOURCE switches, and all selected indicators on the plug-in units. For approximately three seconds after power-up the following indicators will remain off: all positions of the VERTICAL and HORIZONTAL MODE switches, all Intensity indicators, all red front-panel (measurement keyboard) and Waveform Calculator indicators.
- Step 2:** All positions of the VERTICAL and HORIZONTAL MODE switches, all Intensity indicators, and all red front-panel and Waveform Calculator indicators will now light.
- Step 3:** A fault condition found through any of the four tests is indicated with the lights of the VERTICAL and HORIZONTAL MODE switches. Fault condition codes are listed in Table 1-3. Be sure to note the code received so that you may more fully inform the service person about the trouble.

Page 1-10

FOR SN B099999 AND BELOW
CONSTANT REGISTER

A storage register which is able to hold only one constant at a time.

Option	Number CNS Registers	CNS Number
ØD	Ø	—
Standard	5Ø	Ø-49
2D	1ØØ	Ø-99

FOR SN B100000 AND ABOVE
CONSTANT REGISTER

A storage register which is able to hold only one constant at a time.

Option	Number CNS Registers	CNS Number
Standard	100	Ø-99

DESCRIPTION

Page 2-7

FOR SN B099999 AND BELOW

TABLE 2-1 (CONT)
Electrical Characteristics

Characteristic	Performance Requirements
EXTERNAL CONNECTORS (Cont)	
EXTERNAL KEYBOARD	25-pin female rear panel connector for connecting an external keyboard.
GPB IEEE-488-1978	24-pin female rear-panel connector for connecting instrument to GPB. Meets IEEE 488-1978. (Not available on Option 00).
MEMORY BACK-UP POWER	Two rear-panel female banana jacks. Provides connections for external power to maintain power on RAM, thereby providing non-volatile memory.
Voltage Requirement	6.0 to 6.5 V dc.
TTL SIGNAL OUTPUT SWL/SWH	Rear-panel bnc connector provides TTL-compatible signal.
Output Level	Set by user commands available on the Waveform Calculator.
SWL Command	Selects low level output (between 0 V and -0.8 V). Maximum current sink is 18 mA.
SWH Command	Selects high level output (between +2.4 V and +5.0V). Maximum current source is 2.8 mA.
+SAWTOOTH OUT	Rear-panel bnc connector.
Polarity	Positive-going with baseline at 0 V, within 1 V, into 1 M Ω load.
Output Voltage	10 V maximum
Rise Time into 50 Ω	50 mV/unit-of-time, selected by the time-base unit time/div switch, within 15%. 100 ns/div maximum.
Rise Time into 1 M Ω	1 V/unit-of-time, within 10%, selected by the time-base unit time/div switch; 1 μ s/div maximum.
Output Resistance	Approximately 250 Ω .

DESCRIPTION

Page 2-7

FOR SN B10000 AND ABOVE

TABLE 2-1 (CONT)
Electrical Characteristics

Characteristic	Performance Requirements
EXTERNAL CONNECTORS (Cont)	
EXTERNAL KEYBOARD	25-pin female rear-panel connector for connecting an external keyboard.
GPIB IEEE 488-1978	24-pin female rear-panel connector for connecting instrument to GPIB. Meets IEEE 488-1978. (Not available on Option 0D).
TTL SIGNAL OUTPUT SWL/SWH	Rear-panel bnc connector provides TTL-compatible signal.
Output Level	Set by user commands available on the Waveform Calculator.
SWL Command	Selects low level output (between 0 V and -0.8 V). Maximum current sink is 16 mA.
SWH Command	Selects high level output (between +2.4 V and +5.0V). Maximum current source is 2.8 mA.
-SAWTOOTH OUT	Rear-panel bnc connector.
Polarity	Positive-going with baseline at 0 V, within 1 V, into 1 M Ω load.
Output Voltage	10 V maximum.
Rise Time Into 50 Ω	50 mV/unit-of-time, selected by the time-base unit time/div switch, within 15%, 100 ns/div maximum.
Rise Time Into 1 M Ω	1 V/unit-of-time, within 10%, selected by the time-base unit time/div switch; 1 μ s/div maximum.
Output Resistance	Approximately 950 Ω .

DESCRIPTION

FOR SN B099999 AND BELOW

On the back of divider page

Section Five 7854

Using the Measurement Keyboard

This section of the manual demonstrates, in the form of self-teaching exercises, the operation of all front-panel measurement keyboard commands, except those given in the EXTERNAL block. These exercises are for the Option ØD 7854 Oscilloscope which can be operationally simulated by disconnecting the Waveform Calculator and the GPIB cables from the oscilloscope rear-panel connectors.

All displays shown in the exercises in this manual are correct for the given conditions—specified and previously displayed real-time waveform, the position of the stored waveform, etc.—but might not be exactly duplicated on your instrument due to the extreme sensitivity of the processor. Therefore, your readings may vary slightly from those shown in the exercise displays.

In addition to the exercises to demonstrate the WFM ACQUISITION, CURSOR, and WFM PARAMETER commands available on the measurement keyboard, this section includes information on:

1. Waveform storage considerations;
2. The command buffer;
3. Error and warning indications; and
4. The character display in the STORED and BOTH modes.

DESCRIPTION

FOR SN B100000 AND ABOVE

On the back of divider page

**Section Five
7854**

**Using the
Measurement Keyboard**

This section of the manual demonstrates, in the form of self-teaching exercises, the operation of all front-panel measurement keyboard commands, except those given in the EXTERNAL block. These exercises can be performed by disconnecting the Waveform Calculator and the GPIB cables from the oscilloscope rear-panel connectors.

All displays shown in the exercises in this manual are correct for the given conditions—specified and previously displayed real-time waveform, the position of the stored waveform, etc.—but might not be exactly duplicated on your instrument due to the extreme sensitivity of the processor. Therefore, your readings may vary slightly from those shown in the exercise displays.

In addition to the exercises to demonstrate the WFM ACQUISITION, CURSOR, and WFM PARAMETER commands available on the measurement keyboard, this section includes information on:

1. Waveform storage considerations;
2. The command buffer;
3. Error and warning indications; and
4. The character display in the STORED and BOTH modes.

NOTE

Memory Backup SW must be in Self-Test on Turn On position for these exercises.

DESCRIPTION

Page 5-1

First Paragraph
FOR SN B099999 AND BELOW

WAVEFORM STORAGE CONSIDERATIONS

Before measurements can be made by the processor, the real-time waveform must be stored in waveform memory. With Option 00, only one waveform can be stored at a time. Scale factors (vertical deflection factor and horizontal sweep rate) with units, and the vertical zero reference (VZR) are stored in memory with the waveform points since all are required to fully specify the waveform value.

First Paragraph
FOR SN B100000 AND ABOVE

WAVEFORM STORAGE CONSIDERATIONS

Before measurements can be made by the processor, the real-time waveform must be stored in waveform memory. Scale factors (vertical deflection factor and horizontal sweep rate) with units, and the vertical zero reference (VZR) are stored in memory with the waveform points since all are required to fully specify the waveform value.

Page 5-21

FOR SN B099999 AND BELOW

POSITIONING THE CURSORS (Cont)

After turning on both cursors, position Cursor 1 to the left edge of the graticule and Cursor 2 to the center vertical graticule line. Then:

Press	Comments
CRS1>	Notice that as Cursor 1 passes through the center vertical graticule line it picks up Cursor 2 and both move toward the right.
CRS1<	Move Cursor 1 at least one division to the left of Cursor 2.
CRS2<	CRS WARNING is issued when Cursor 2 meets Cursor 1. Notice that Cursor 2 cannot pick up Cursor 1.
OFF	Turn cursors off.

NEXT EXERCISE BEGINS WITH POWER-UP

DESCRIPTION

Page 5-21

FOR SN B100000 AND ABOVE

POSITIONING THE CURSORS (Cont)

After turning on both cursors, position Cursor 1 to the left edge of the graticule and Cursor 2 to the center vertical graticule line. Then:

Press	Comments
CRS1>	Notice that as Cursor 1 passes through the center vertical graticule line it picks up Cursor 2 and both move toward the right.
CRS1<	Move Cursor 1 at least one division to the left of Cursor 2.
CRS2<	CRS WARNING is issued when Cursor 2 meets Cursor 1. Notice that Cursor 2 cannot pick up Cursor 1.
OFF	Turn cursors off.

NEXT EXERCISE BEGINS WITH POWER-UP

NOTE

Memory Backup SW must be in Self-Test on Turn On position.

DESCRIPTION

FOR SN B099999 AND BELOW

On the back of divider page

**Section Six
7854****Using the
Waveform Calculator**

The Waveform Calculator keyboard provides accessibility to increased processing capabilities for stored waveform manipulation and measurement, and for numeric computations. And in addition to the three display modes available with the measurement keyboard, the Waveform Calculator provides command programming which allows a repetitive command sequence to be performed automatically by the processor.

This section builds upon the information presented in sections 1 through 5 of this manual and should be read in sequence.

This section discusses only the increased capabilities available with the Waveform Calculator and is divided into two subsections:

1. Stored Display Mode Information—additional information pertaining to the STORED display mode using the Waveform Calculator; and
2. Programming—a discussion of programming using the Waveform Calculator.

DESCRIPTION

FOR SN B100000 AND ABOVE

On the back of divider page

Section Six 7854

Using the Waveform Calculator

The Waveform Calculator keyboard provides accessibility to increased processing capabilities for stored waveform manipulation and measurement, and for numeric computations. And in addition to the three display modes available with the measurement keyboard, the Waveform Calculator provides command programming which allows a repetitive command sequence to be performed automatically by the processor.

This section builds upon the information presented in sections 1 through 5 of this manual and should be read in sequence.

This section discusses only the increased capabilities available with the Waveform Calculator and is divided into two subsections:

1. Stored Display Mode Information—additional information pertaining to the STORED display mode using the Waveform Calculator; and
2. Programming—a discussion of programming using the Waveform Calculator.

NOTE

Memory Backup SW must be in Self-Test on Turn On.

DESCRIPTION

Page 6-17

FOR SN B099999 AND BELOW

USING THE CONSTANT REGISTERS

In addition to accumulation of intermediate results by the stack, fifty constant registers (100 with Option 2D) are accessible for the storage of constants. These constant registers are unaffected by operations occurring within the stack and are referenced with address numbers 0 through 49 (0 through 99 with Option 2D).

STORING A CONSTANT

To store the number 2.5 in constant register 4: press 2.5, ENTER, 4, f, >CNS.

To store a number in a constant register:

- Key in the constant.
- Terminate numeric entry by pressing ENTER.
- Key in the register address number (0 through 49, or 0 through 99 with Option 2D) where the constant is to be stored.
- Press f >CNS.

>CNS Operation: The contents of the Y register are copied into the constant register designated by the address number in the X register, then the X register is popped and the constant is displayed in the X register field.

>CNS Restriction: The contents of the X register (constant register address) must be an integer between, and including, 0 through 49 (0 through 99 with Option 2D).

RETRIEVING A CONSTANT

To copy data from a constant register to the X register: first key in the constant register address, then press CNS. To recall the number 2.5 from register 4: press 4, CNS. The stored constant is retrieved and displayed in the X register field.

CNS Operation: The content of the constant register (designated by the address number in the X register) is copied into the X register.

CNS Restriction: Initially the X register must contain a constant which (when rounded) is an integer between, and including, 0 through 49 (0 through 99 with Option 2D).

DESCRIPTION

Page 6-17

FOR SN B100000 AND ABOVE

USING THE CONSTANT REGISTERS

In addition to accumulation of intermediate results by the stack, one hundred constant registers are accessible for the storage of constants. These constant registers are unaffected by operations occurring within the stack and are referenced with address numbers 0 through 99.

STORING A CONSTANT

To store the number 2.5 in constant register 4: press 2.5, ENTER, 4, f, >CNS.

To store a number in a constant register:

- Key in the constant.
- Terminate numeric entry by pressing ENTER.
- Key in the register address number (0 through 99) where the constant is to be stored.
- Press f >CNS.

>CNS Operation: The contents of the Y register are copied into the constant register designated by the address number in the X register, then the X register is popped and the constant is displayed in the X register field.

>CNS Restriction: The contents of the X register (constant register address) must be an integer between, and including, 0 through 99.

RETRIEVING A CONSTANT

To copy data from a constant register to the X register: first key in the constant register address, then press CNS. To recall the number 2.5 from register 4: press 4, CNS. The stored constant is retrieved and displayed in the X register field.

CNS Operation: The content of the constant register (designated by the address number in the X register) is copied into the X register.

CNS Restriction: Initially the X register must contain a constant which (when rounded) is an integer between, and including, 0 through 99.

DESCRIPTION

Page 6-18

FOR SN B099999 AND BELOW

WAVEFORM MEMORIES AND RESOLUTION

The memory space available within the processor for waveform storage is a fixed amount; however, the utilization of this space is selectable by the operator. By setting the points-per-waveform (P/W) value the waveform memories are allocated and the stored waveform resolution is selected. The available P/W values (except on the Option 00 instrument which is set at 512) are 128, 256, 512, and 1024; all stored waveforms are the same resolution at any given time. In addition to determining stored waveform resolution, the selected P/W value also determines the number of waveform memories available at any given time. The higher the P/W value selected, the greater the resolution, but fewer waveforms can then be stored. Table 6-1 summarizes the effects of each P/W value on waveform resolution, waveform memories, and the stored waveforms.

Changing the P/W value initiates a major rearrangement of the waveform memories such that all stored data and status information contained in waveform memory is drastically affected. Prior to a >P/W (Set Points/Waveform) command, each waveform memory contains the vertical coordinates of the waveform points, the vertical zero reference level, and the scale factors associated with the waveform points.

FOR SN B100000 AND ABOVE

WAVEFORM MEMORIES AND RESOLUTION

The memory space available within the processor for waveform storage is a fixed amount; however, the utilization of this space is selectable by the operator. By setting the points-per-waveform (P/W) value the waveform memories are allocated and the stored waveform resolution is selected. The available P/W values are 128, 256, 512, and 1024; all stored waveforms are the same resolution at any given time. In addition to determining stored waveform resolution, the selected P/W value also determines the number of waveform memories available at any given time. The higher the P/W value selected, the greater the resolution, but fewer waveforms can then be stored. Table 6-1 summarizes the effects of each P/W value on waveform resolution, waveform memories, and the stored waveforms.

Changing the P/W value initiates a major rearrangement of the waveform memories such that all stored data and status information contained in waveform memory is drastically affected. Prior to a >P/W (Set Points/Waveform) command, each waveform memory contains the vertical coordinates of the waveform points, the vertical zero reference level, and the scale factors associated with the waveform points.

DESCRIPTION

Page 6-19

FOR SN B099999 AND BELOW

TABLE 6-1
>P/W Effects

7854 Version	P/W Value	Total Waveform Memories	Waveform Memory Addresses	Waveform Point Numbers	Number of Points Per Horizontal Graticule Division
7854 With Option 0D	512	2	0-1	0-511	51.2
Standard 7854	128	16	0-5	0-127	12.8
	256	8	0-7	0-255	25.6
	512	4	0-3	0-511	51.2
	1024	2	0-1	0-1023	102.4
With Option 2D	128	40	0-39	0-127	12.8
	256	20	0-19	0-255	25.6
	512	10	0-9	0-511	51.2
	1024	5	0-4	0-1023	102.4

FOR SN B100000 AND ABOVE

TABLE 6-1
>P/W Effects

7854 Version	P/W Value	Total Waveform Memories	Waveform Memory Addresses	Waveform Point Numbers	Number of Points Per Horizontal Graticule Division
Standard 7854	128	40	0-39	0-127	12.8
	256	20	0-19	0-255	25.6
	512	10	0-9	0-511	51.2
	1024	5	0-4	0-1023	102.4

DESCRIPTION

Page 6-95

First Paragraph

FOR SN B099999 AND BELOW

Program memory will hold a maximum of 920 (commands plus line numbers), 2000 with Option 20, and a maximum of 1000 program lines. If the program memory is full and you attempt to enter an additional command: (1) The ERROR indicators will light; (2) the audible warning tone will be issued if the AUDIBLE ERROR/WARNING switch is ON; (3) the display will blink; and (r) commands other than CLL (Clear Line), CLP (Clear Program), or EXECUTE, will not be accepted.

First Paragraph

FOR SN B100000 AND ABOVE

Program memory will hold a maximum of 2000 (commands plus line numbers), and a maximum of 1000 program lines. If the program memory is full and you attempt to enter an additional command: (1) The ERROR indicators will light; (2) the audible warning tone will be issued if the AUDIBLE ERROR/WARNING switch is ON; (3) the display will blink; and (r) commands other than CLL (Clear Line), CLP (Clear Program), or EXECUTE, will not be accepted.

FOR SN B099999 AND BELOW

On the back of divider page

**Section Seven
7854**

**GPIB
Information**

The 7854 (except Option 00) is equipped with an interface which conforms to IEEE Standard 488-1978 Digital Interface for Programmable Instrumentation, commonly referred to as a General Purpose Interface Bus, or GPIB.

The GPIB allows permanent storage of 7854 programs, remote programming of the 7854, and data transfers to and from the 7854.

DESCRIPTION

FOR SN B100000 AND ABOVE

On the back of divider page

Section Seven 7854

GPIB Information

The 7854 is equipped with an interface which conforms to IEEE Standard 488-1978 Digital Interface for Programmable Instrumentation, commonly referred to as a General Purpose Interface Bus, or GPIB.

The GPIB allows permanent storage of 7854 programs, remote programming of the 7854, and data transfers to and from the 7854.

Page 8-1

FOR SN B099999 AND BELOW

OPTION 02

Option 02 provides X-Y mode phase correction of the real-time signals. A horizontal delay line and compensation network equalizes the signal delay between either vertical compartment and the horizontal deflection system. With this network installed and activated, the phase shift between the vertical and horizontal systems is adjustable to less than 2° from dc to one megahertz.

OPTION 03

With Option 03 installed, the instrument will meet the EMC (electromagnetic compatibility) specifications given in section 2.

OPTION 78

Replaces standard crt phosphor with P11.

OPTION 0D

Deletes the Waveform Calculator and GPIB facilities by removing 2000 words of memory, and replacing the rear-panel GPIB connector and ADDRESS SELECTION switches with a blank panel. Operation of the instrument will not change except that the front-panel RQS key and I/O, SRQ, and REMOTE ONLY indicators are inoperative. All access to the Waveform Calculator commands is denied when the 2K of memory is removed.

OPTION 2D

An additional 4096 words of memory are added with Option 2D to expand the program memory, waveform memory, and constant registers. Program memory is increased to a maximum of 2000 commands, waveform memory is increased to 5120 waveform points, and the constant registers are increased to 100.

OPTION A1

The standard power cord is replaced with the Universal European 220-volt type power cord (Tektronix Part 161-02066-09).

DESCRIPTION

OPTION A2

The standard power cord is replaced with the UK240-volt type power cord (Tektronix Part 161-02066-10).

OPTION A3

The standard power cord is replaced with the Australian 240-volt type power cord (Tektronix Part 161-02066-11).

OPTION A4

The standard power cord is replaced with the North American 240-volt type power cord (Tektronix Part 161-02066-12).

Page 8-1
FOR SN B100000 AND ABOVE

OPTION 02

Option 02 provides X-Y mode phase correction of the real-time signals. A horizontal delay line and compensation network equalizes the signal delay between either vertical compartment and the horizontal deflection system. With this network installed and activated, the phase shift between the vertical and horizontal systems is adjustable to less than 2° from dc to one megahertz.

OPTION 03

With Option 03 installed, the instrument will meet the EMC (electromagnetic compatibility) specifications given in section 2.

OPTION 78

Replaces standard crt phosphor with P11.

OPTION A1

The standard power cord is replaced with the Universal European 220-volt type power cord (Tektronix Part 161-02066-09).

OPTION A2

The standard power cord is replaced with the UK240-volt type power cord (Tektronix Part 161-02066-10).

OPTION A3

The standard power cord is replaced with the Australian 240-volt type power cord (Tektronix Part 161-02066-11).

OPTION A4

The standard power cord is replaced with the North American 240-volt type power cord (Tektronix Part 161-02066-12).

DESCRIPTION

Page 8-2

(third paragraph)

FOR SN B099999 AND BELOW

INSTRUMENT OPTION IDENTIFICATION

7854 Oscilloscopes with one or more options have a tag attached to the rear-panel of the mainframe to identify each included option (Ø2, Ø3, 78, ØD, 2D, A1, A2, A3, or A4). The tag(s) will be located as shown in Figure 8.1 Instruments with Options 1S or 2S will not have any identification tag since these options are not part of the 7854 Oscilloscope.

(third paragraph)

FOR SN B100000 AND ABOVE

INSTRUMENT OPTION IDENTIFICATION

7854 Oscilloscopes with one or more options have a tag attached to the rear-panel of the mainframe to identify each included option (Ø2, Ø3, 78, A1, A2, A3, or A4). The tag(s) will be located as shown in Figure 8.1 Instruments with Options 1S or 2S will not have any identification tag since these options are not part of the 7854 Oscilloscope.

DESCRIPTION

Page 8-3
FOR SN 809999 AND BELOW

TABLE 8-1
Option Information Locator

Option	Location in Manual		Information
	Section	Heading	
02	8 Instrument Options	Option	Gives a brief description of Option 02.
03	3 General Operating Information	Light Filter	Mentions that the crt mesh filter is included with Option 03.
	8 Instrument Options	Option 03	Gives a brief description of Option 03.
78	8 Instrument Options	Option 78	Gives a brief description of Option 78.
00	1 Introduction	General Purpose Interface Bus	Mentions that, except for instruments with Option 00, the 7854 has a GPIB.
		Introduction	Describes use of keyboard on 7854 Option 00.
	5 Using The Measurement Keyboard	Waveform Storage Considerations	Explains that with Option 00, only one waveform can be stored at a time.
		Selecting Both CRT Display Mode	Describes display modes of 7854 Option 00.
6 Using The Waveform Calculator (Waveform Processing)	Waveform Memories & Resolution	Mentions that the Option 00 instrument will not process waveforms.	
	Waveform Acquisition And Data Storage	Lists parameters of pulse acquisition for standard and Option 00 instruments in Table 6-1.	

DESCRIPTION

Page 8-3
FOR SN B100000 AND ABOVE

TABLE 8-1
Option Information Locator

Option	Location in Manual		Information
	Section	Heading	
02	8 Instrument Options	Option	Gives a brief description of Option 02
03	3 General Operating Information	Light Filter	Mentions that the air mesh filter is included with Option 03
	8 Instrument Options	Option 03	Gives a brief description of Option 03
78	8 Instrument Options	Option 78	Gives a brief description of Option 78

DESCRIPTION

Page 8-4
FOR SN 8099999 AND BELOW

TABLE 8-1 (CONT)
Option Information Locator

Option	Location in Manual		Information
	Section	Heading	
00 (cont)	7 GPIB Information	Introduction	Mentions that Option 00 deletes the GPIB, the Waveform Calculator keyboard, and 2,000 words of memory.
	8 Instrument Options	Option 00	Gives a brief description of Option 00.
20	6 Using The Waveform Calculator (Stored Display Mode Info)	Using The Constant Registers	Explains how the constant registers are referenced (by addresses 0-99) with Option 20.
		Storing A A Constant	Explains how the constant registers are referenced (by addresses 0-99) with Option 20.
		Retrieving A Constant	Explains how the constant registers are referenced (by addresses 0-99) with Option 20.
	(Waveform Processing)	Waveform Acquisition & Data Storage	Lists parameters of pulse acquisition for standard and Option 20 instruments in Table 6-1.
		Observing The Waveform Memories At Power-Up	Mentions that the X register must contain a number within the limits of the P/W setting for Option 20.
	8 Instrument Options	Option 20	Gives a brief description of Option 20.
	9 Command Language	Error And Warning Messages, Table 9-20	Mentions that the X register does not contain a constant between zero and 99.
		Displayed CNS Error Messages, CNS ERROR and >CN	Mentions that the X register does not contain a constant between zero and 99.

DESCRIPTION

Page 9-22
FOR SN B100000 AND ABOVE

EXTERNAL FUNCTIONS

Table 9-7 lists the external interface commands executed from both the Waveform Calculator keyboard or the measurement keyboard.

TABLE 9-7
External Interface Commands

Command	Execution	
ID (Identify)	Function: Identifies following data on CRT screen.	
	Display Line	Display Format
	9	TEK7854 ¹ , V79.12 ² @1 ³ .99 ⁴ , 8K ⁵ A NU MEMORY
	10	ADDRESS: 10 ⁶ TALK LISTEN ⁷ EOI ⁸
	12	ON ⁹ : ROE IOC REM EXR CER OPC
	13	OFF ⁹ :
	1	Device Type.
	2	Implemented version of Codes and Format Standard.
	3	ROM version.
	4	ROM patch version for specified ROM version.
	5	Instrument memory capability by option:
		Memory Option
		8K (standard)
	6	GPIB address.
7	GPIB modes.	
8	Message terminator.	
9	GPIB service request command status.	
A	NV MEMORY indicates Memory Back Up Mode.	
	Self Test.	